

## 2 F-B LGA DESCRIPTION

This chapter provides a detailed description of the Fresno to Bakersfield Locally Generated Alternative (F-B LGA), developed in close coordination between the California High-Speed Rail Authority (Authority) and the City of Bakersfield, as well as the City of Shafter and Kern County. The design drawings supporting the description of this alternative are included as Volume III (Alignments and Other Plans) of this Draft Supplemental Environmental Impact Report/Environmental Impact Statement (EIR/EIS). The F-B LGA discussed in this chapter is a new alternative that was not previously evaluated in the Fresno to Bakersfield Section Final EIR/EIS (Authority and Federal Railroad Administration [FRA] 2014). Technical reports containing technical analyses and data supporting the impacts evaluations in this Draft Supplemental EIR/EIS are accessible from the Authority's website. Visit the Authority website ([www.hsr.ca.gov](http://www.hsr.ca.gov)) to view and download the Draft Supplemental EIR/EIS, to request a CD-ROM copy of the Draft Supplemental EIR/EIS, or to locate a library to review the Draft Supplemental EIR/EIS in hard copy. Printed copies of the Draft Supplemental EIR/EIS have been placed in public libraries in the following cities: Shafter and Bakersfield.

This Draft Supplemental EIR/EIS analyzes the potential environmental impacts of the F-B LGA, including direct and indirect impacts, cumulative impacts. The Draft Supplemental EIR/EIS also identifies appropriate mitigation measures (Appendix 2-G, Mitigation Monitoring and Enforcement Plan [MMEP, as amended], and Project Design Features (Appendix 2-H, Functions of Impact Avoidance and Minimization Measures, of this Draft Supplemental EIR/EIS) as well as any secondary effects of implementing mitigation.

As discussed in Section 1.1.3 of this Draft Supplemental EIR/EIS, for the purpose of understanding the potential impacts of the F B LGA, this Draft Supplemental EIR/EIS compares the F-B LGA to the complementary portion of the Preferred Alternative that was identified in the *Fresno to Bakersfield Section California High-Speed Train Final Project Environmental Impact Report/Environmental Impact Statement*. The complementary portion of the Preferred Alternative (further referenced as the "May 2014 Project" in this Draft Supplemental EIR/EIS) consists of the portion of the BNSF Alternative from Poplar Avenue to Hageman Road and the Bakersfield Hybrid Alternative from Hageman Road to Oswell Street. The May 2014 Project is described in more detail in Section 2.3. In addition to the description in each resource section, more detailed impact analysis summaries for the May 2014 Project are located in Technical Appendix 8-A to help facilitate the comparison with the F-B LGA.

### 2.1 Fresno to Bakersfield Section and the Draft Supplemental EIR/EIS

The Fresno to Bakersfield Section Final EIR/EIS considered the impacts associated with three alternative alignments through Bakersfield, and ultimately the Authority and FRA identified the Bakersfield Hybrid as the Preferred Alternative through Bakersfield. On June 5, 2014, the City of Bakersfield filed a state court lawsuit challenging the Authority's EIR and approvals under the California Environmental Quality Act (CEQA). The City claimed that the Preferred Alternative alignment identified in the 2014 Fresno to Bakersfield Section Final EIR/EIS would severely impact the City's ability to utilize existing city assets, including its corporation yard, senior housing, and parking facilities at the Rabobank Arena, Theatre and Convention Center; would render unusable one of the city's premier health facilities; and would affect the Bakersfield Commons project, a retail/ commercial/ residential development.

In a settlement agreement between the City of Bakersfield and the Authority, the two agencies agreed to work together to develop and study a Fresno to Bakersfield Locally Generated Alternative (F-B LGA) to address concerns and meet the Authority's design requirements. The F-B LGA described and analyzed in this Draft Supplemental EIR/EIS evolved from this mutual cooperation and subsequent public input.

Since the release of the Fresno to Bakersfield Section Final EIR/EIS, the United States Fish and Wildlife Service issued an amended Biological Opinion (USFWS 2017a)<sup>1</sup> for the Fresno to Bakersfield Section from East American Avenue in Fresno County (the northern terminus of Construction Package 2/3) to Poplar Avenue in Kern County (the southern terminus for Construction Package 3/4). The amended Biological Opinion addresses effects on the federally endangered Buena Vista Lake ornate shrew (*Sorex ornatus relictus*). The amended Biological Opinion for the Fresno to Bakersfield Section also removed the valley elderberry longhorn beetle from further consideration in the Fresno to Bakersfield Section due to the reduced species range; revised effects to include additional activities for the Tipton kangaroo rat and blunt-nosed leopard lizard; addressed the effects of additional activities on the Central California Distinct Population Segment of the California tiger salamander; and revised effects due to increased disturbance acreage for the blunt-nosed leopard lizard, San Joaquin kit fox, Tipton kangaroo rat, Kern mallow, San Joaquin woolly threads, and Hoover's spurge. The potential impacts associated with the federally endangered Buena Vista Lake ornate shrew were not documented in the Fresno to Bakersfield Section Final EIR/EIS because, at the time of approval, the range of the species did not extend into the proposed Fresno to Bakersfield Section study area. New studies have been conducted since the certification of the Fresno to Bakersfield Section Final EIR/EIS, indicating that the range of the species includes portions of the Fresno to Bakersfield Section of the HSR System. Therefore, pursuant to CEQA Guidelines Section 15163, this Draft Supplemental EIR/EIS accounts for the expansion of the range of species and considers potential effects to the Buena Vista Lake ornate shrew for the entirety of the Fresno to Bakersfield Section.

### 2.1.1 Development of the F-B LGA

The Authority, in cooperation with the City of Bakersfield, and also the City of Shafter and Kern County, conducted a high-level analysis to assess the feasibility and practicability of potential alternatives to carry forward into preliminary design and environmental review in this Draft Supplemental EIR/EIS. High-level concepts were developed based on the original alignment and station location provided by the City of Bakersfield. The City's concept outlined an HSR alignment parallel to Union Pacific Railroad (UPRR) from 7th Standard Road to Oswell Street. In conjunction with the City, the Authority refined the City's concept to establish the F-B LGA. While there were additional alternative alignments, stations, and maintenance of infrastructure facility (MOIF) locations that were discussed with the cities of Bakersfield and Shafter, Kern County, and various stakeholders, they were determined infeasible and were not evaluated further in the feasibility analysis. The various concepts either did not satisfy HSR program objectives, would be substandard and impractical from a technical perspective when compared to an F Street Station location, and/or would be incompatible with the future land use.

As part of the feasibility analysis, the Authority screened alternatives based on HSR design criteria and environmental factors as well as input provided by the Cities of Bakersfield and Shafter, Kern County, and members of the public. When developing the geographic scope of the F-B LGA, the Authority and FRA identified a northern terminus (i.e., Poplar Avenue) allowing for a full evaluation of the impacts that could result from the F-B LGA. This enables the agencies to focus their review on an alignment and station alternative that was not evaluated in the Fresno to Bakersfield Section Final EIR/EIS. While the northern terminus is within the section of the Fresno to Bakersfield Project Section approved by both the Authority and FRA, no final design or construction activities will occur in areas being analyzed in this Draft Supplemental EIR/EIS prior to its approval. However, this does not preclude the Authority from advancing project activities north of Poplar Avenue including those described in Sections 2.1.1 through 2.1.6 of this Draft Supplemental EIR/EIS. The following alignment alternatives were evaluated in the screening process:

- **Through Shafter (Elevated/Embankment):**
  - Alternative A1: BNSF Adjacent (HSR Elevated)

---

<sup>1</sup> It should be noted that the Fresno to Bakersfield Biological Opinion approved in 2014 covered the entire length of the Fresno to Bakersfield Section of the HSR System from the City of Fresno to the City of Bakersfield (a 117-mile stretch of the HSR alignment).

- Alternative A2: BNSF Adjacent (HSR Embankment)
- **Shafter to Bakersfield (At-Grade)**
  - Alternative B1: North of Burbank Street
  - Alternative B2: South of Burbank Street
  - Alternative B3.1: 7th Standard Road
  - Alternative B3.2: 7th Standard Road Intermodal Yard Avoidance
  - Alternative B4: Snow Road
- **7th Standard to the F Street Station (Elevated):**
  - Alternative C1: North of Burbank Street – Adjacent to UPRR North of 7th Standard Road
  - Alternative C2: South of Burbank Street – Parallel and Offset from UPRR North of 7th Standard Road
  - Alternative C3: Snow Road
  - Alternative C4: Snow Road – Reduced Design Speed with Minimized Property Impacts
- **South of F Street Station to Oswell Street (Elevated):**
  - Alternative D1: Sumner and Edison Streets Adjacent
  - Alternative D2: Sumner and Edison Streets Adjacent/Center – Reduced Design Speed with Minimized Property Impacts

In addition to the evaluation of alignment options described above, the vertical alignment (profile) was also evaluated. Through Shafter, a raised/retained embankment alignment was assumed, to avoid impacts to the local street system and businesses within Shafter. Between Shafter and Bakersfield, the Authority determined a mostly at-grade profile was feasible. However, through a series of Technical Working Group meetings with the City of Bakersfield, the Authority determined that an elevated structure would be required through Bakersfield due to physical constraints that would prevent an at-grade profile including, but not limited to, the crossings of State Route (SR) 99, SR 178, railroad spurs, the Kern River, and above ground utilities. In addition, greater community impacts would likely result from an at-grade profile due to required relocations of major freeways.

Based on the screening process, which included input from the Cities of Bakersfield and Shafter and the public, the Authority recommended the F-B LGA for further study (which is comprised of the A2, B1, C1, and D2 alternatives listed above). The F-B LGA provides a 23.13-mile alternative alignment between the city of Shafter and the city of Bakersfield and is the subject of this Draft Supplemental EIR/EIS, which supplements the Fresno to Bakersfield Section Final EIR/EIS (Authority and FRA 2014).

The Authority has also collaborated with the City of Shafter and Kern County to develop design alternatives within their respective jurisdictions. The design option through the city of Shafter would include removal of the existing BNSF at-grade crossings at Poplar Avenue, Fresno Avenue, W Shafter Avenue, Central Avenue, E Lerdo Highway, S Beech Avenue, and Riverside Street, and includes placing the BNSF and HSR on a parallel embankment. Section 2.5.1.5 of this chapter describes the design option for the proposed 7th Standard Road interchange.

## 2.1.2 Approved Activities North of Poplar Avenue

The Authority is currently advancing project activities within the approved portion of the Fresno to Bakersfield Section between the Fresno station and Poplar Avenue in Kern County. These activities are consistent with the Authority's May 2014 approval, the FRA's June 2014 Record of Decision, and the Mitigation Monitoring and Enforcement Plan (MMEP). Key milestones include:

### 2.1.2.1 Acquire Right-of-Way

- Acquire right-of-way for Fresno/Bakersfield section north of Poplar Avenue
- Conduct property maintenance activities (e.g., fencing, mowing, establishing firebreaks, etc.)
- Demolish structures and capping wells to maintain public health, safety, and welfare
- Resolve severed access issues, consistent with MMEP
- Implement Farmland Consolidation Program

### **2.1.3 Retain Design-Build Contractors, Develop Design, Begin Construction, Continued Work with Stakeholders and Public**

- Retain design-build contractors to construct Fresno to Bakersfield Section alignment between Fresno and Poplar Avenue in Kern County
- Refine project electrical interconnection facilities
- Advance project design to final design, including some refinements such as:
  - Utility relocations and other early work
  - Closing some roadways and opening others
  - Refining the vertical profile of the track
  - Shifting the alignment to avoid major infrastructure
  - Adding drainage basins
  - Column placement based on refined bridge design
- Implement impact avoidance and minimization measures and mitigation measures
- Engage with stakeholders and public during final design and construction

### **2.1.4 Implement Habitat Mitigation**

- Retain habitat mitigation services firm
- Proceed with real estate transaction
- Establish fencing and habitat restoration
- Implement mitigation strategies identified in the amended Fresno to Bakersfield Biological Opinion (USFWS 2017a) for the Buena Vista Lake ornate shrew

### **2.1.5 Study Electrical Interconnections and Network Upgrades**

- Project changes to electrical interconnection facilities resulting from further design include:
- Minor movement of traction power supply stations, switching stations, and electrical tie lines
- Expansion of the existing PG&E substation north of SR 178 near the intersection of 30th Street and Union Avenue to accommodate HSR equipment
- New utility switching stations and HSR traction power supply station
- Completion of the Pacific Gas & Electric 2015 Technical Study Report, which was reviewed by the Authority and its technical consultant, determined what network upgrades would be required to existing Pacific Gas & Electric infrastructure to meet the projected power demands of the HSR system. Within the geographic limits of the F-B LGA, it was determined that PG&E network upgrades would not be immediately needed.
- PG&E network upgrades may not be immediately necessary within the F-B LGA segment, since projected train power demand loads initially provided to PG&E have since been significantly revised downward. If PG&E determines that network upgrades are needed (e.g., conductor replacement), it will be the result of accumulation of increased power demands from other users on a given circuit, not necessarily just the addition of load demand from HSR operations. There may be substation upgrades needed to serve the HSR project, but it will generally be circuitry modifications needed to supply power for the Traction Power Substation Site. In addition to this work, the Authority will also be constructing its own interconnections from the PG&E system to the HSR system.

### **2.1.6 Ongoing Collaboration with Local Agencies**

- Develop and implement early works for Tulare County
- Final design of grade separation of BNSF railway
- Eliminate an over crossing at the request of local residents
- Coordinate with Ponderosa Pines neighborhood

As part of the design/build process, contractors may propose project design refinements as project engineering advances. In response to these refinements, the Authority and FRA



determine whether a subsequent or supplemental environmental document should be prepared and circulated. Both agencies have determined the project design refinements incorporated to date do not result in any new or substantially more severe impacts than previously identified in the Fresno to Bakersfield Section Final EIR/EIS.

## 2.2 Potential Alternatives Considered During Alternatives Screening Process

For a complete discussion of the alternatives considered during development of the Fresno to Bakersfield Section, please refer to Chapter 2, Alternatives, Sections 2.4.2 and 2.4.3 of the Fresno to Bakersfield Section Final EIR/EIS (pages 2-54 through 2-72) (Authority and FRA 2014). Additionally, Section 2.2 of the Fresno to Bakersfield Section Final EIR/EIS (page 2-3) provides information on HSR system performance criteria, infrastructure, and systems, which would apply to the HSR, including the May 2014 Project and the F-B LGA. Topics discussed include: System Design Performance, Safety, and Security (pages 2-4 and 2-5); Vehicles (pages 2-5 and 2-6); Stations (pages 2-6 through 2-8); Station Platforms and Trackway (Station Box) (page 2-8); and Station Arrival/Departure (page 2-8).

### 2.2.1 No Project Alternative

The Fresno to Bakersfield Section Final EIR/EIS (Authority and FRA 2014) evaluated a No Project Alternative, which considered the effects of planned regional growth, as well as existing and planned transportation projects, including improvements to the highway, aviation, conventional passenger rail, and freight rail systems in the Fresno to Bakersfield Section vicinity. In June 2014, the FRA issued a Record of Decision, which considered the information and analysis contained in the 2011 Draft EIS (Authority and FRA 2011), the 2012 Supplemental Draft EIS (Authority and FRA 2012), and the 2014 Final EIS (Authority and FRA 2014) and identified the BNSF Alternative with the Kings/Tulare – East Station in combination with the Corcoran Bypass, Allensworth Bypass, and Bakersfield Hybrid alignments and the Truxtun Avenue Station as the selected alternative. For a full description of the No Project Alternative, refer to Section 2.4.1 (pages 2-37 through 2-54) of the Fresno to Bakersfield Section Final EIR/EIS.

In May 2014, the Authority certified the Fresno to Bakersfield Section Final EIR/EIS. While the analysis in the Final EIR/EIS was certified from the Fresno Station to the Bakersfield Station, the Authority's project approval was from the southern limit of the Fresno Station to the north side of 7th Standard Road, the city limit of the city of Bakersfield. The Final EIR/EIS analyzed the No Project Alternative; however, in certifying the Final EIR/EIS and identifying the Preferred Alternative (which includes the May 2014 Project), the Authority determined that the Preferred Alternative achieved the project goals and objectives and was preferable to the No Project Alternative. The No Project Alternative is not analyzed further in this Draft Supplemental EIR/EIS, and the F-B LGA is compared to the May 2014 Project from Poplar Avenue in the city of Shafter to Oswell Street in the city of Bakersfield.<sup>2</sup>

<sup>2</sup> It should be noted that Section 3.2, Transportation, and Section 3.3, Air Quality and Global Climate Change, of this Draft Supplemental EIR/EIS analyze a No Project Alternative for the purpose of providing baseline conditions for the evaluation of traffic and air quality and global climate change impacts. For a project such as the HSR project that would not commence operation of HSR service for almost 10 years and would not reach full operation for almost 25 years, use of only existing conditions as a baseline for air quality and transportation impacts would be misleading. It is more likely that existing background traffic volumes (and background roadway changes from other programmed traffic improvement projects) and vehicle emission factors would change between today and 2020/2035 than it is that existing conditions would remain unchanged over the next 10 to 25 years. For example, regional transportation plans included funded transportation projects programmed to be constructed by 2035. To ignore that these projects would be in place before the HSR project reaches maturity (i.e., the point/year at which HSR-related traffic and emissions would reach its maximum), and to evaluate the HSR project's air quality and transportation impacts ignoring these regional transportation plan improvements would change the underlying background conditions to which HSR project traffic would be added and be misleading because it would represent a hypothetical comparison. Therefore, the air quality and transportation analyses for operations use a dual-baseline approach. That is, the HSR project's air quality and transportation impacts are evaluated both against existing conditions and against background (i.e., No Project) conditions as they are expected to be in 2035.

## 2.3 May 2014 Project

This Draft Supplemental EIR/EIS compares the F-B LGA to the complementary portion of the Preferred Alternative that was identified in the Fresno to Bakersfield Section Final EIR/EIS (the “May 2014 Project”). The May 2014 Project consists of a portion of the BNSF Alternative from Poplar Avenue to Hageman Road and the Bakersfield Hybrid from Hageman Road to Oswell Street (Figure 2-1). The May 2014 Project alignment runs primarily at-grade as it follows the BNSF corridor and SR 43 through Shafter and SR 58 into Bakersfield. It parallels the F-B LGA until approximately Beech Avenue, where it diverges from the F-B LGA, parallels the BNSF right-of-way in a southeasterly direction, and then curves back to the northeast to parallel the BNSF tracks toward Kern Junction. After crossing Truxtun Avenue, the alignment curves to the southeast to rejoin the F-B LGA and parallel the UPRR tracks and Edison Highway to its terminus at Oswell Street. The May 2014 Project begins at-grade but elevates through Shafter for a distance of about 4 miles between North Shafter Avenue and Cherry Avenue and in Bakersfield at Country Breeze Place and continues as an elevated structure all the way to the project terminus at Oswell Street. Refer to Section 2.4.2 and Section 2.4.3.10 (page 2-72) of the Fresno to Bakersfield Section Final EIR/EIS for more detail associated with the BNSF Alternative and Bakersfield Hybrid, which comprise the May 2014 Project (Authority and FRA 2014).

The May 2014 Project Station would be built at the corner of Truxtun and Union Avenues/SR 204 (Figure 2-1). The entire site would be approximately 24 acres, with 15 acres designated for the station, bus transit center, short-term parking, and park-and-ride areas. Approximately 4.5 of the 24 acres would support three parking structures with a total capacity of approximately 4,500 cars. An additional 460 parking spaces would be provided in surface lots covering a total of approximately 4.5 acres of the station site. The balance of the supply needed to accommodate the full 2035 parking demand (8,100 total spaces) would be identified as a part of a comprehensive parking strategy developed in coordination with the City of Bakersfield. Refer to Section 2.4.4.3 (page 2-80) of the Fresno to Bakersfield Section Final EIR/EIS for more detail associated with the May 2014 Project Station (Authority and FRA 2014). Figure 2-43 (page 2-87) of the Fresno to Bakersfield Section Final EIR/EIS depicts the conceptual layout of the May 2014 Project Station (Authority and FRA 2014).

A MOIF would be located along the May 2014 Project alternative just north of the City of Bakersfield and 7th Standard Road (Figure 2-1). The MOIF would be sized and outfitted to support the maintenance of infrastructure requirements for 75 miles of HSR system track in either direction. Regional maintenance machinery servicing storage, materials storage, and maintenance and administration would be offered at the MOIF. Refer to Section 2.2.8.1 (pages 2-15 and 2-16) of the Fresno to Bakersfield Section Final EIR/EIS for more detail associated with the May 2014 MOIF (Authority and FRA 2014).

## 2.4 Locally Generated Alternative

This section provides a detailed description of the F-B LGA. The Preliminary Engineering for Project Definition drawings showing the track alignments, profiles, structures, typical sections, construction use areas, and other preliminary design information are included as Volume III (Alignments and Other Plans) of the Draft Supplemental EIR/EIS and are available on the Authority’s website ([www.hsr.ca.gov](http://www.hsr.ca.gov)).

Figure 2-2 shows the F-B LGA, and associated features, such as locations of road closures, road modifications, new road overcrossings or undercrossings, the F Street Station location, and the location of the MOIF.

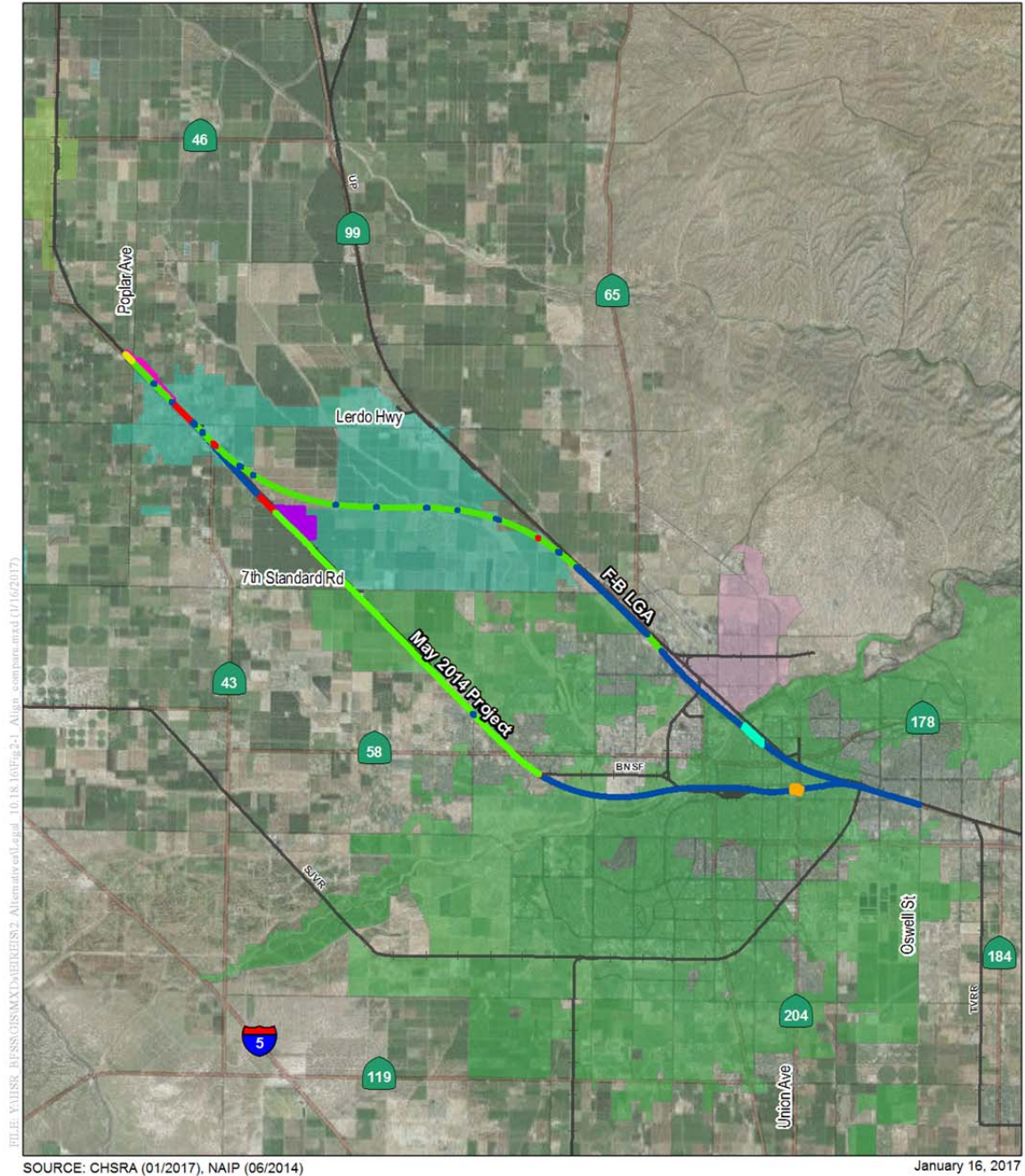

SOURCE: CHSRA (01/2017), NAIP (06/2014)

January 16, 2017

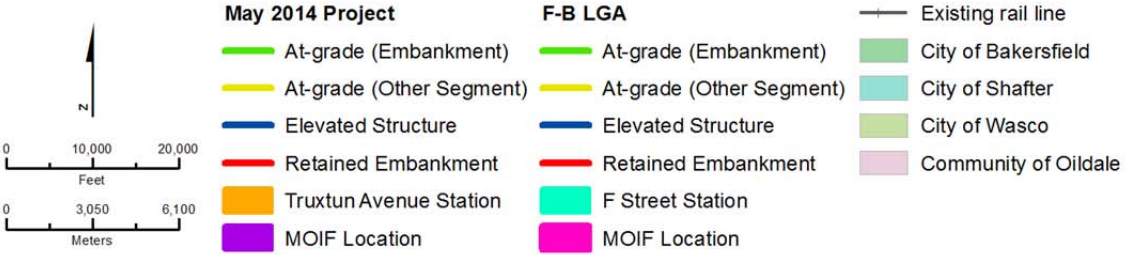

Figure 2-1 F-B LGA and May 2014 Project



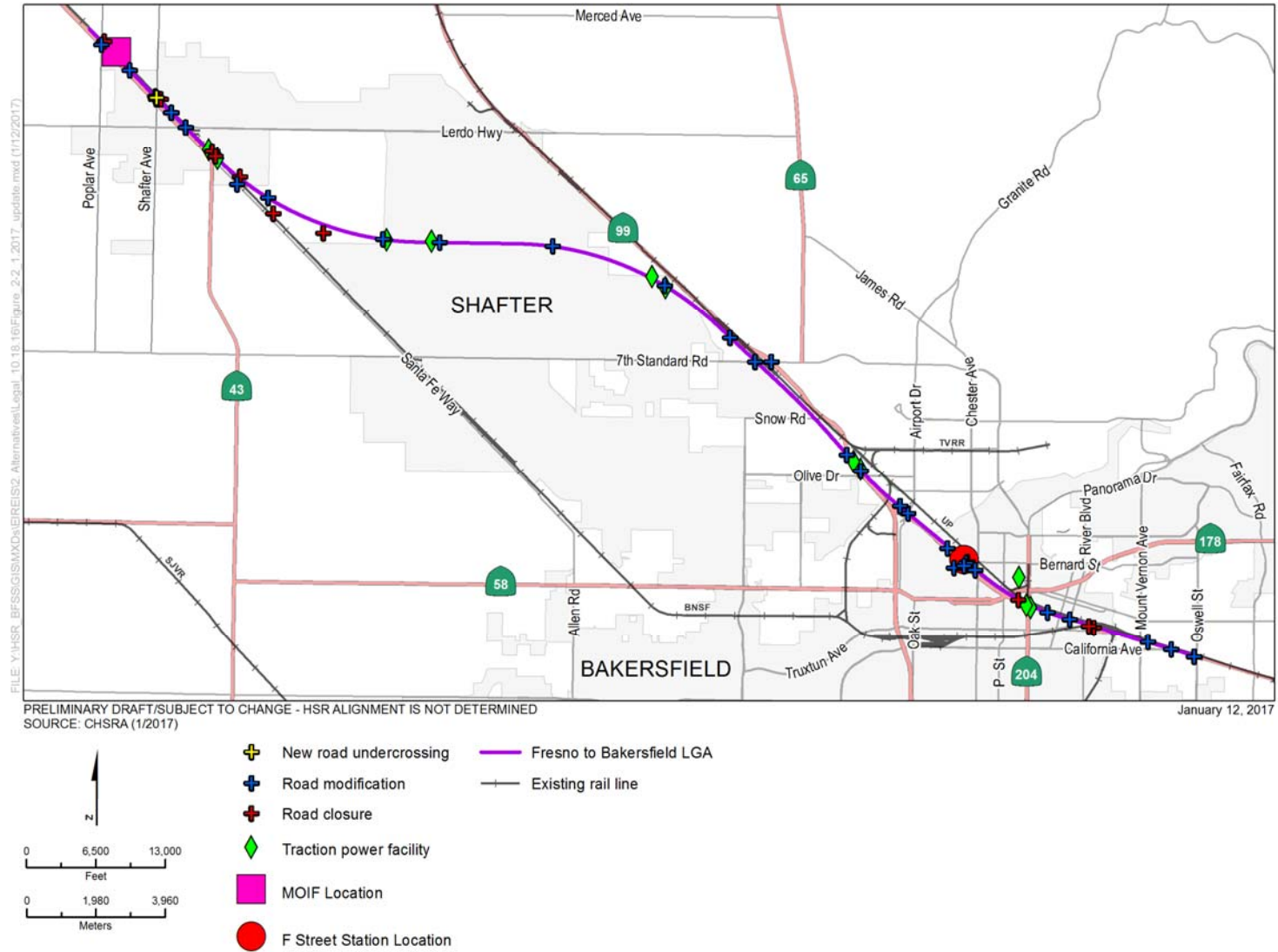

Figure 2-2 F-B LGA and Associated Features

## 2.4.1 Alignment Requirements

The F-B LGA would traverse urban downtown areas in the cities of Shafter and Bakersfield. The alignment would be located generally adjacent to the BNSF corridor through the city of Shafter (as shown below on Figure 2-3, Figure 2-4, and Figure 2-5). It would then traverse the area between the BNSF and UPRR corridors, then continue adjacent, or nearly adjacent, to the UPRR corridor through the community of Oildale and the city of Bakersfield, as shown on Figure 2-6, Figure 2-7, and Figure 2-8. The height of the at-grade profile of the F-B LGA may vary to accommodate slight changes in topography and to provide clearance for stormwater culverts and structures in order to allow water flow and occasional wildlife movement. Some of the main requirements for the F-B LGA are described in further detail in Section 2.4.5 of this chapter. Some of the main requirements of the HSR alignment are described in detail in Section 2.4.2.1, Alignment Requirements, of the Fresno to Bakersfield Final EIR/EIS (Authority and FRA 2014, page 2-54). A description of the alternatives analyzed in the Fresno to Bakersfield Section Final EIR/EIS is provided in Section 2.4, Alignment, Station, and Heavy Maintenance Facility Alternatives Evaluated in this Project EIR/EIS (Authority and FRA 2014, pages 2-37 through 2-100). See also Figure 1-3 in Chapter 1 of this Draft Supplemental EIR/EIS for a depiction of the May 2014 Project and F-B LGA in relation to the alternatives analyzed in the Fresno to Bakersfield Section Final EIR/EIS.

The F-B LGA would consist of the following characteristics and elements:

- The total length of the alignment would be 23.13 miles, which includes:
  - 10.52 miles on embankment or at-grade<sup>3</sup>
  - 0.43 mile on bridges
  - 0.31 mile on steel truss
  - 1.97 mile on retained fill
  - 9.90 miles on viaduct
- No length of alignment would be below-grade or in a trench.
- The average height of the viaduct is 60 feet above existing ground.
- Straddle bents<sup>4</sup> would be constructed in various locations where center support columns cannot be used in order to avoid constraints, such as roadways. Figure 2-9 shows the straddle bent design that would be implemented as part of the F-B LGA.
- The alignment crosses several existing railroads, including various BNSF and UPRR tracks.
- The alignment crosses one major waterway, the Kern River, within the city of Bakersfield.
- The alignment crosses seven canals.
- The F-B LGA would include 43 road crossings, including 41 undercrossings and 2 overcrossings. Of these road crossings, 12 would be in the city of Shafter, 30 would be in the city of Bakersfield; and one (7th Standard Road) would be co-located in the cities of Shafter and Bakersfield.
  - The F-B LGA would cross 12 roads in the city of Shafter, as described below.
    - One overcrossing at Poplar Avenue.
    - 11 undercrossings at the following locations: Fresno Avenue; W Shafter Avenue; Central Avenue; Mannel Avenue; E Lerdo Highway; Riverside Street; Cherry Avenue; Driver Road; Zachary Avenue; Zerker Road; and Verdugo Lane.

<sup>3</sup> Fill materials required for the project would be obtained from commercially available sources because no borrow sites have been identified. Acquisition of additional fill material would be reflected in the design-bid contractor's bid (F-B LGA PEPD Record Set Constructability Assessment Memorandum (Oct 2016), Page 5-1, Section 5.3 Earthwork, paragraph 2.)

<sup>4</sup> A pier structure that spans the functional/operational right-of-way limit of a roadway, highway, or railway.



**This page intentionally left blank**





FILE: Y:\HSR\_BFSS\GIS\MXD\REIS\2\_Alternatives\LePal\_10.18.16\Alignment\_6pg.mxd (10/26/2016)

PRELIMINARY DRAFT/SUBJECT TO CHANGE  
SOURCE: Basemap - ESRI World Imagery (2014); Mapping - CHSRA (9/2016)

October 27, 2016

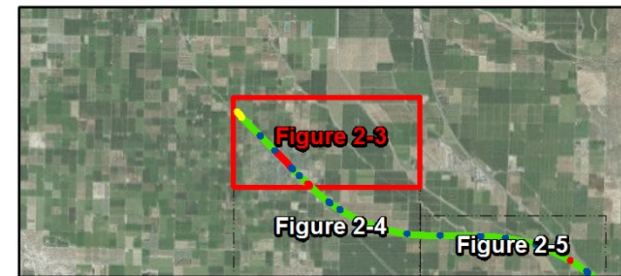
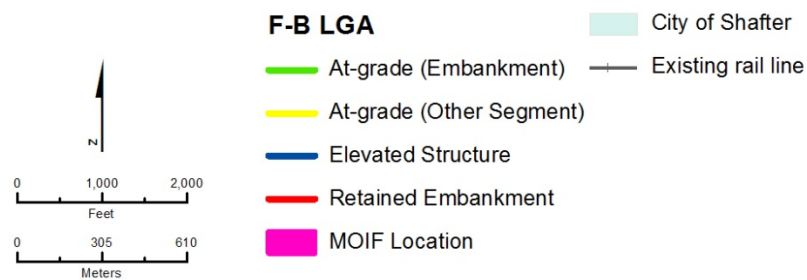
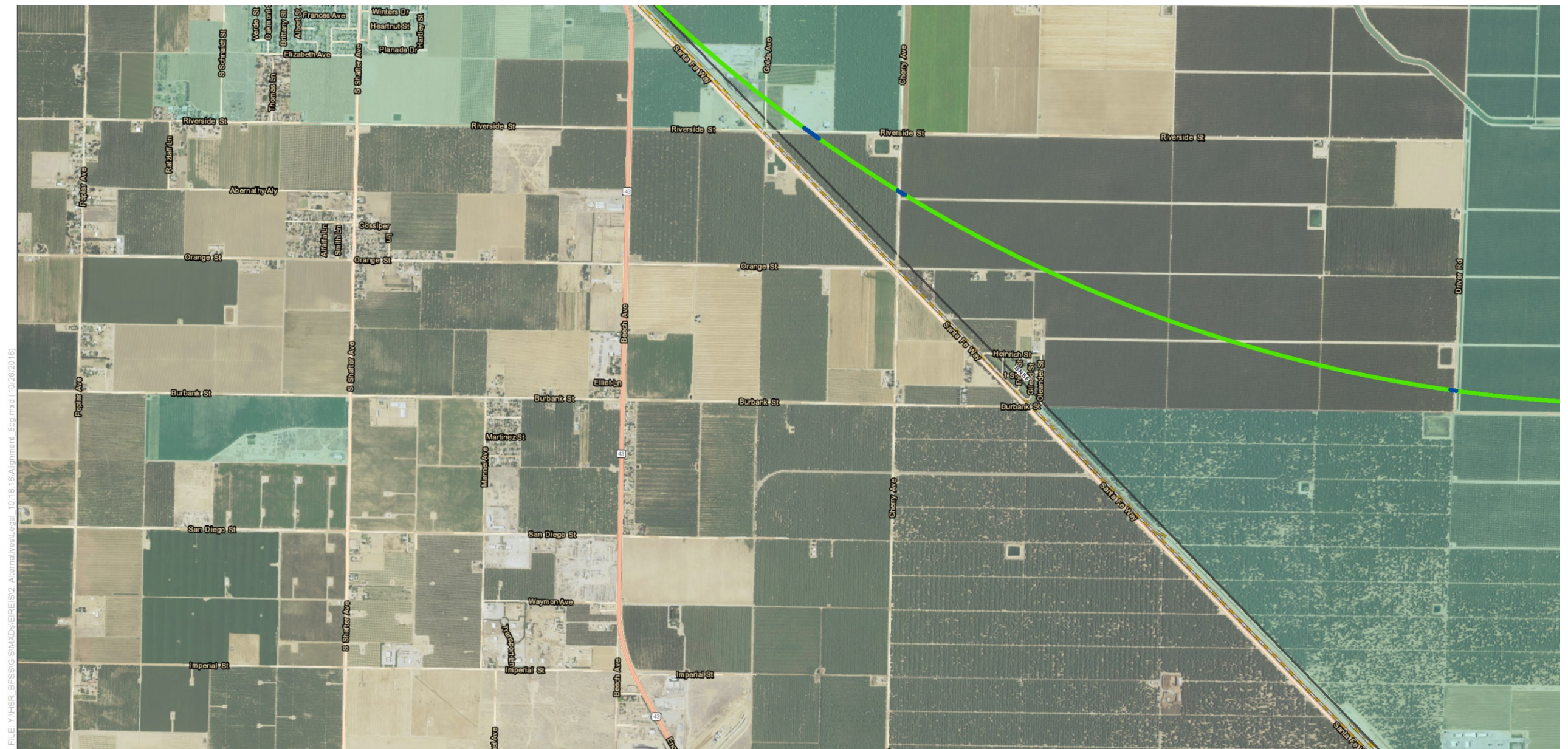

Figure 2-3 F-B LGA in Kern County and Shafter





FILE: Y:\HSR\_BFSS\GIS\MXD\ERES\C\_01\1616\Alignment\_699.mxd (10/26/2016)

PRELIMINARY DRAFT/SUBJECT TO CHANGE  
SOURCE: Basemap - ESRI World Imagery (2014); Mapping - CHSRA (9/2016)

October 27, 2016

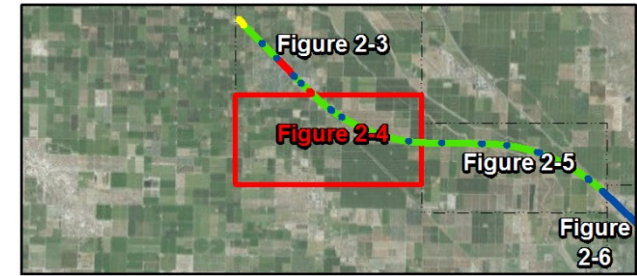
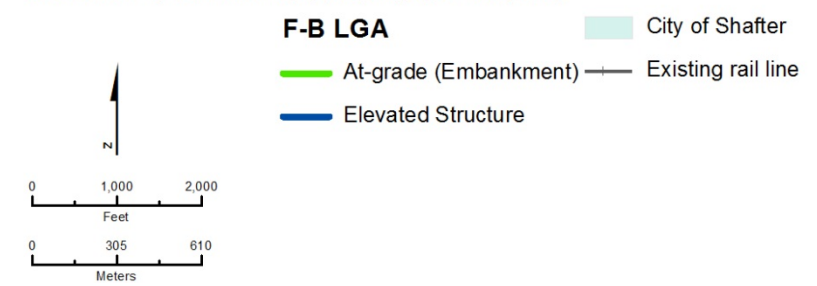
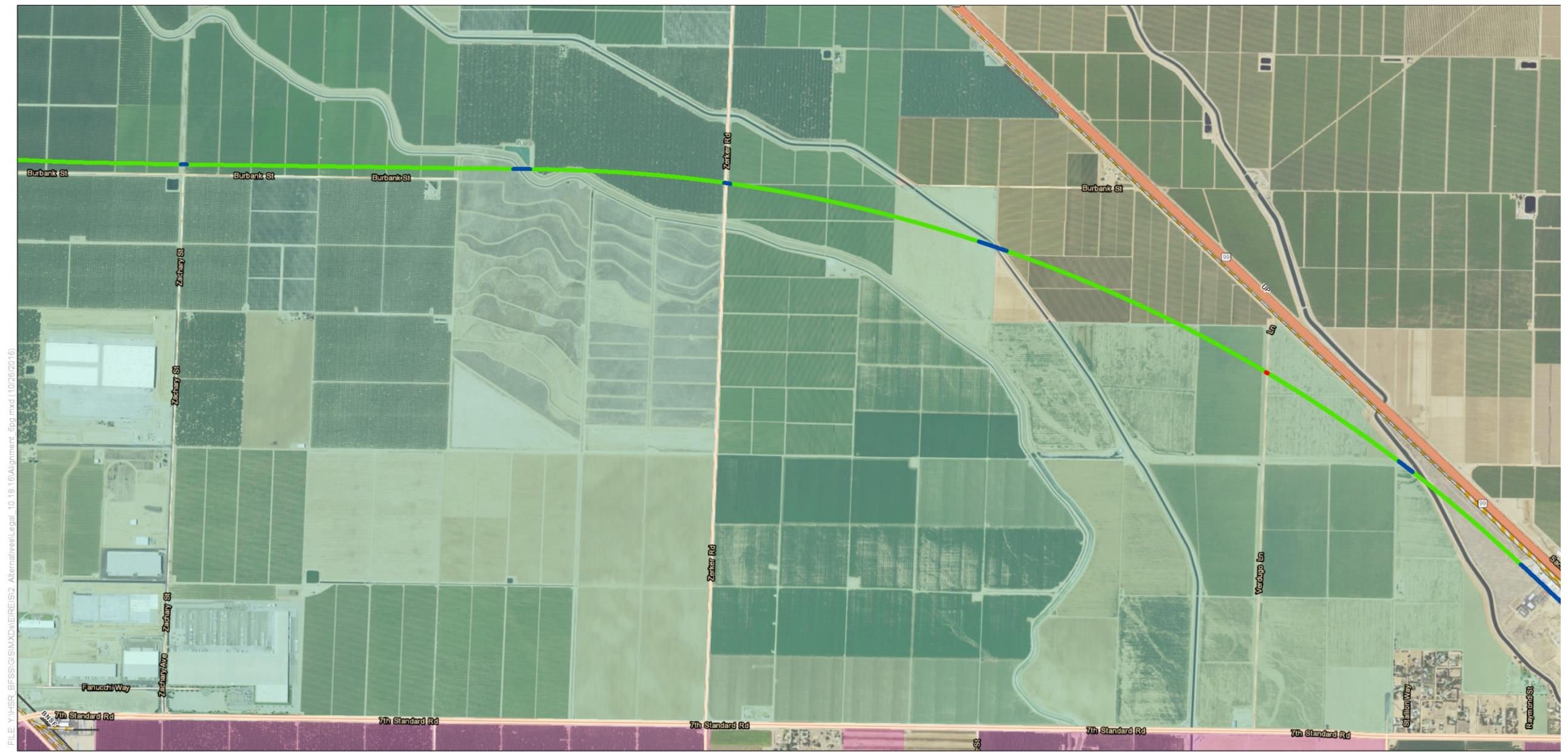

Figure 2-4 F-B LGA in Shafter and Kern County





PRELIMINARY DRAFT/SUBJECT TO CHANGE  
 SOURCE: Basemap - ESRI World Imagery (2014); Mapping - CHSRA (9/2016)

October 27, 2016

**F-B LGA**

At-grade (Embankment)	City of Bakersfield
Elevated Structure	City of Shafter
Retained Embankment	Existing rail line

0 1,000 2,000  
 Feet  
 0 305 610  
 Meters

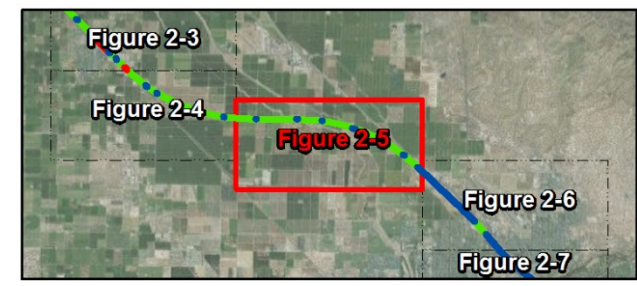

Figure 2-5 F-B LGA in Shafter





FILE: \\HSR\BSS\GIS\MXD\EIR\EIS\2\_Alternative\Lept\_10\_18\_16\Alignment\_Epp.mxd (10/26/2016)

PRELIMINARY DRAFT/SUBJECT TO CHANGE  
SOURCE: Basemap - ESRI World Imagery (2014); Mapping - CHSRA (9/2016)

October 27, 2016

**F-B LGA**

- At-grade (Embankment)
- Elevated Structure
- City of Bakersfield
- Community of Oildale
- Existing rail line

N

0 1,000 2,000  
Feet

0 305 610  
Meters

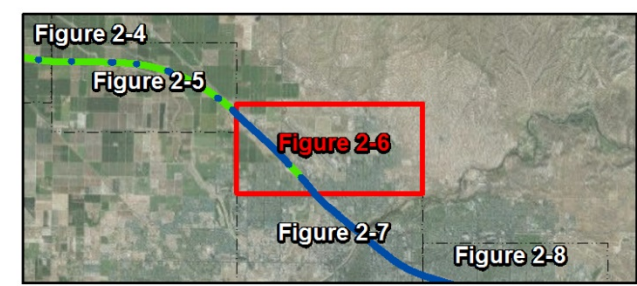
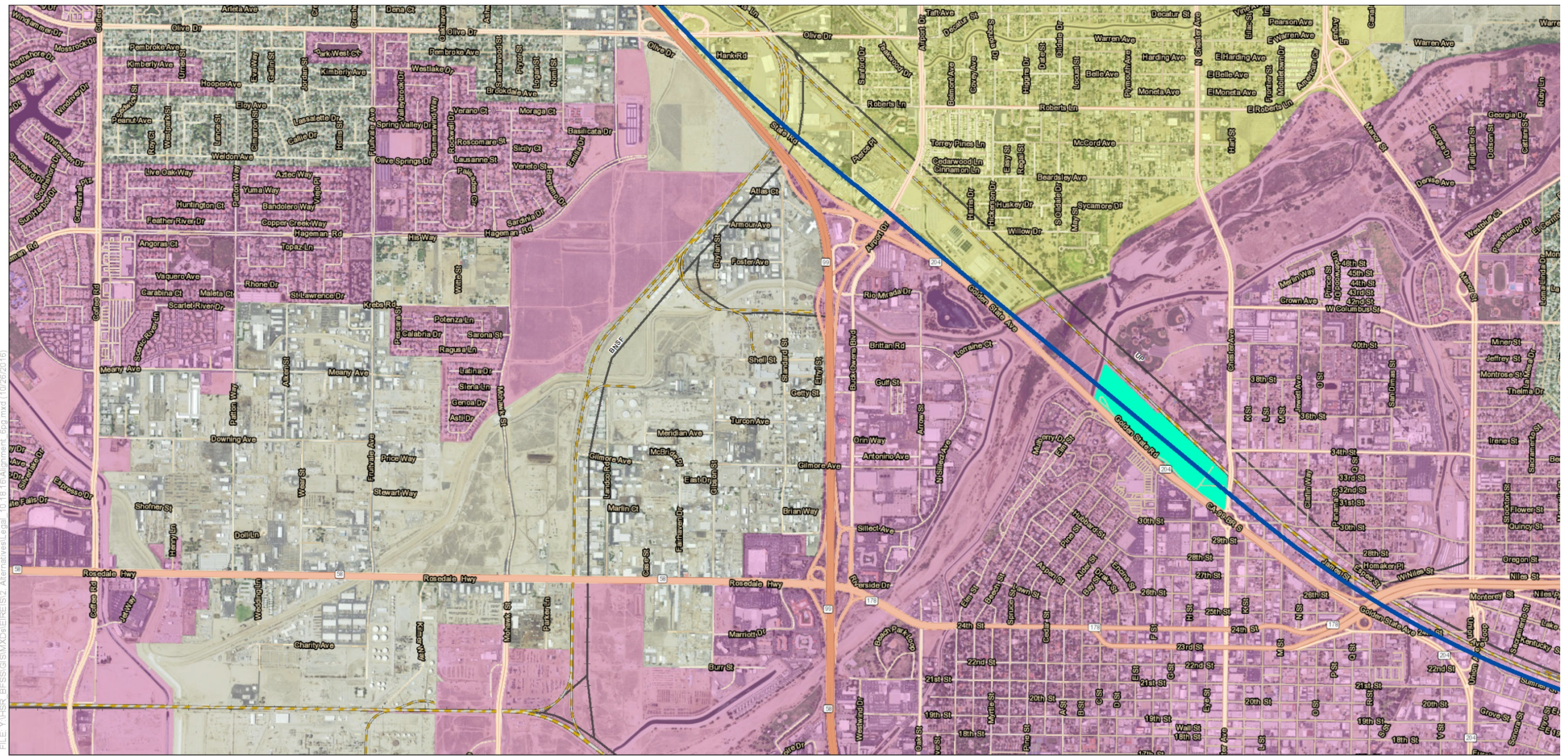

Figure 2-6 F-B LGA in Bakersfield and Oildale





PRELIMINARY DRAFT/SUBJECT TO CHANGE  
 SOURCE: Basemap - ESRI World Imagery (2014); Mapping - CHSRA (9/2016)

October 27, 2016

- F-B LGA**
- Elevated Structure
  - F Street Station
  - City of Bakersfield
  - Community of Oildale
  - Existing rail line

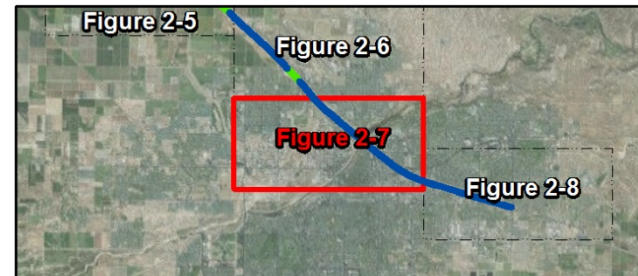
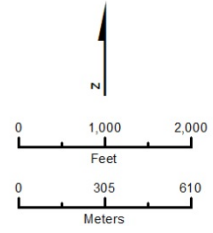
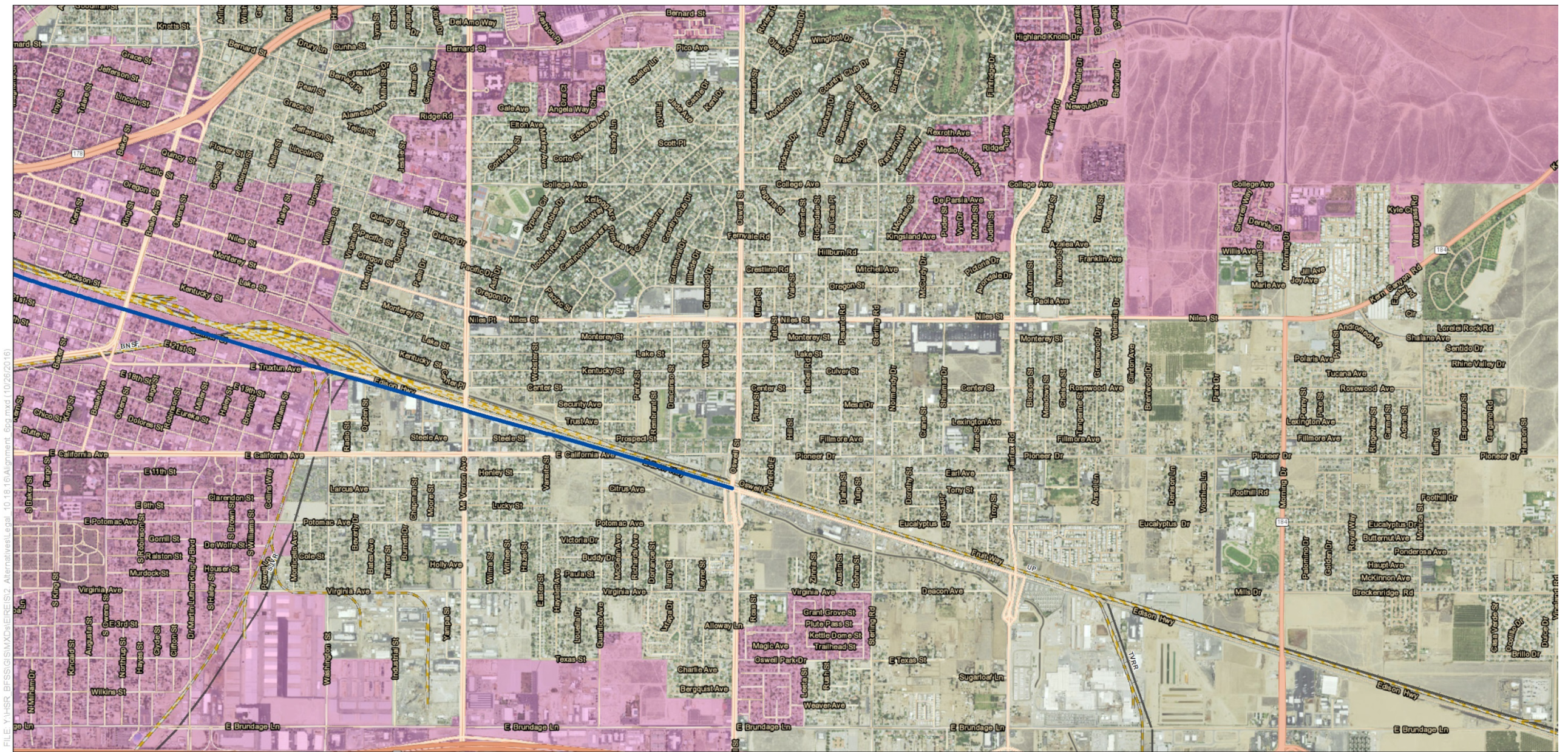

Figure 2-7 F-B LGA in Oildale and Bakersfield





FILE:Y:\HSR\_BFSS\GIS\MapDocs\EIR\2\_Alt\MapDocs\Legal\_10\_18\_16\Alt\MapDocs\_6pp.mxd (10/26/2016)

PRELIMINARY DRAFT/SUBJECT TO CHANGE  
SOURCE: Basemap - ESRI World Imagery (2014); Mapping - CHSRA (9/2016)

October 27, 2016

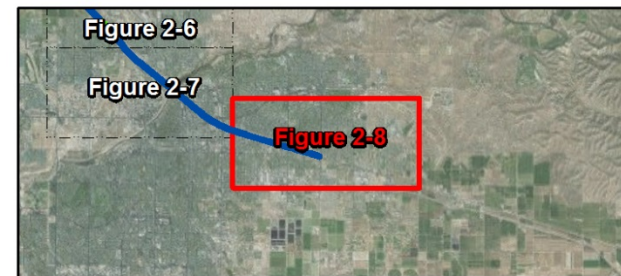
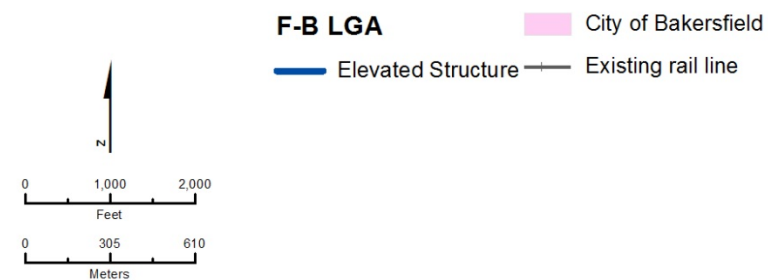

Figure 2-8 F-B LGA in Bakersfield



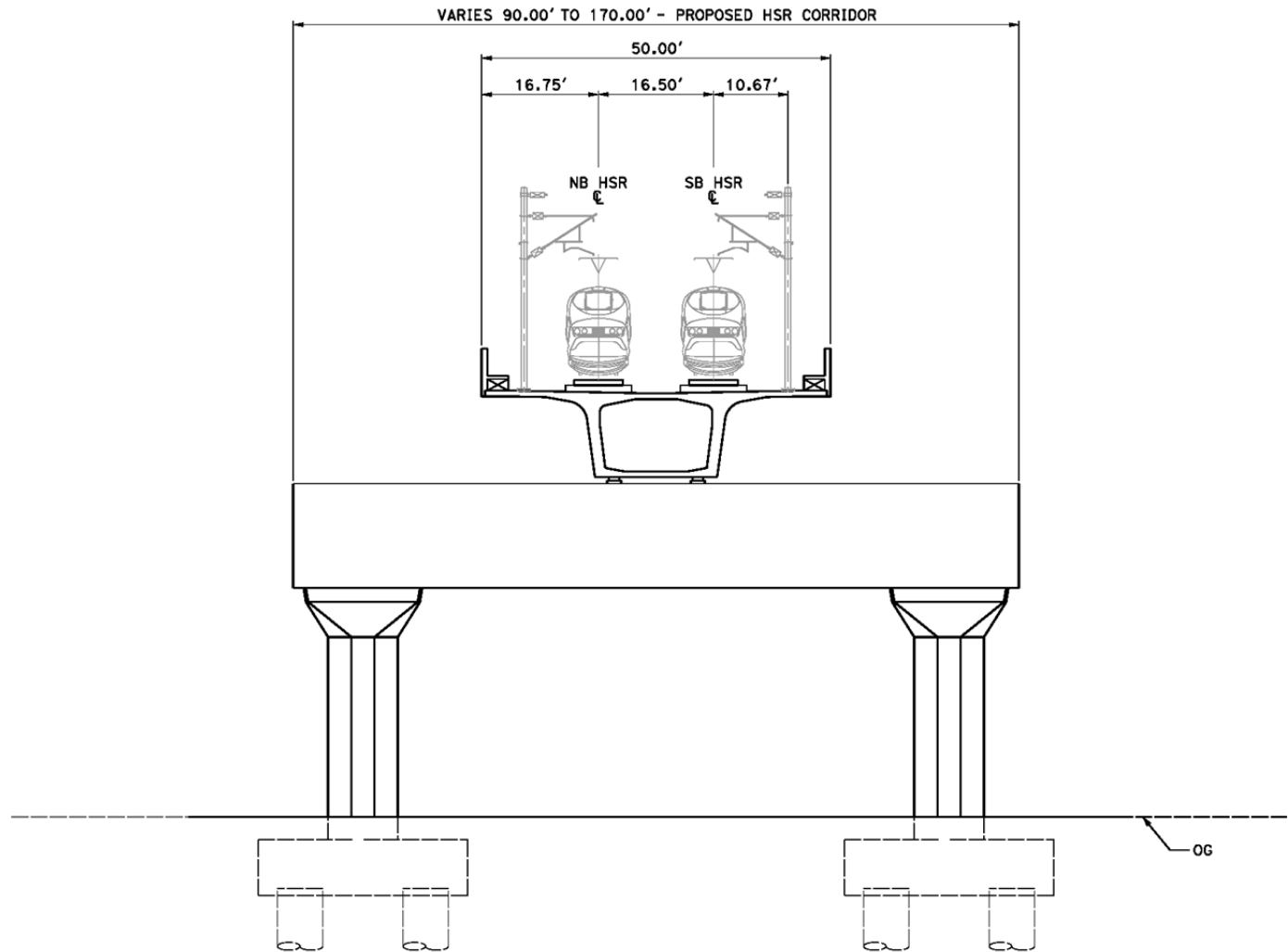

Figure 2-9 Straddle Bent Design

**This page intentionally left blank**

- The F-B LGA would cross 30 roads in the city of Bakersfield, all of which would be undercrossings at the locations listed below.
  - Fruitvale Avenue; Snow Road; Knudsen Drive; SR 99; State Road (first undercrossing); SR 99 on- and off-ramps; Olive Drive; State Road (second undercrossing); State Road (third undercrossing); Airport Drive; SR 99 northbound on-ramp; SR 99 northbound off-ramp; 32nd Street; Chester Avenue; 30th Street; M Street; O Street; Q Street; SR 178; Sumner Street (first undercrossing); Union Avenue; Sumner Street (second undercrossing); Baker Street; Beale Avenue; Truxtun Avenue; Ogden Street; Chamberlain Avenue; Mt. Vernon Avenue; Exchange Street; and Webster Street.
- One overcrossing (7th Standard Road) would be co-located in the cities of Shafter and Bakersfield. The existing roadway will be reconstructed as a viaduct over the F-B LGA.
- The existing interchange of 7th Standard Road/SR 99 would be modified, including the addition of a new westbound to southbound on-ramp.
- The F-B LGA would require 10 road closures, including: Madera Avenue (Shafter); Gold's Avenue (Shafter); Orange Avenue (Shafter); Mendota Street (Shafter); Golden State Frontage Road South (Bakersfield); Golden State Frontage Road North (Bakersfield); H Street (Bakersfield); 24th Street (Bakersfield); Miller Street (Bakersfield); and Haley Street (Bakersfield).
- The F-B LGA would require multiple roadway modifications in the cities of Shafter and Bakersfield. These modifications generally include adding protective barriers, curbs, sidewalks and medians. In some cases, the roadway traffic network would be modified where crossings are closed, and new crossings are constructed.

Please refer to Chapter 2 of the Fresno to Bakersfield Section Final EIR/EIS (pages 2-1 through 2-36) for a description of the HSR system performance criteria, infrastructure, and systems that would apply to the F-B LGA, including information on undercrossing/overcrossing designs, vehicle specifications, station design, and power supply infrastructure. Table 2-1 summarizes the F-B LGA design features.

#### **2.4.2 F-B LGA Adjacency to the BNSF Railway and Union Pacific Railroad**

The F-B LGA would run generally north-south between the cities of Shafter and Bakersfield. The alignment would begin north of Shafter and run east of the BNSF, continuing southeasterly until just north of Burbank Street. From Burbank Street, the alignment would turn east and run north of the Burbank Street corridor until it approaches the UPRR corridor, where the alignment would turn and continue southeast, adjacent to, and west of the UPRR corridor. The alignment would continue southeast into the city of Bakersfield and would diverge from the UPRR corridor. Southwest of the Oildale community, the alignment would cross SR 99 and continue southeast. South of Airport Drive, the alignment would cross and run parallel to the east side of SR 204. This route would continue until the SR 178 crossing, where the alignment would turn east and return parallel to the UPRR corridor.

The F-B LGA would continue generally east within the Sumner Street and Edison Highway corridors and would terminate near Oswell Street.

In Shafter, the F-B LGA southbound alignment would be approximately 85 feet from the easterly boundary of the BNSF. The F-B LGA alignment would continue to transition away from the BNSF through Shafter.



**Table 2-1 Design Features of the F-B LGA**

Design Option	F-B LGA
Total Length (linear miles)	23.13
Length on at-grade profile (linear miles)	10.52
Length on bridge (linear miles)	0.43
Length on steel truss (linear miles)	0.31
Length on retained fill (linear miles)	1.97
Length on viaduct (linear miles)	9.90
Number of Straddle Bents	22
Number of Railroad Crossings	5
Number of Major Water Crossings	1
Number of Canal Crossings	7
Number of Road Crossings	43
Number of Road Crossings – Overcrossings in Shafter	1
Number of Road Crossings – Undercrossings in Shafter	11
Number of Road Crossings – Overcrossings in Bakersfield	0
Number of Road Crossings – Undercrossings in Bakersfield	30
Number of Road Crossings – Shafter/Bakersfield Shared Overcrossing	1
Number of Roadway Closures	10
Number of Roadway Modifications	Multiple
Number of At-Grade Crossings Removed	7
Total Length (linear miles)	23.13

Source: Authority and FRA, 2016

F-B LGA = Fresno to Bakersfield Locally Generated Alternative

In Bakersfield, in order to minimize impacts to buildings and residents along Sumner Street and Edison Highway, the F-B LGA alignment would be located on a viaduct within the existing roadway right-of-way. Both roadways parallel the UPRR southern property boundary. The F-B LGA alignment would be aligned so that the edge of the structure does not fall within the active UPRR operating corridor. The operating corridor is determined by the physical features within the railroad's right-of-way that limit the useable width, such as bridge overpass structures, buildings, and fences. The F-B LGA track on the viaduct would be as close 140 feet from the nearest UPRR ground level track along Sumner Street and as close as 70 feet from the nearest UPRR ground level track along Edison Highway.

### 2.4.3 North-South Alignment

The F-B LGA would run generally north-south between the city of Shafter and the city of Bakersfield. Please refer to Figures 3.16-23 through 3.16-34 in Section 3.16, Aesthetics and Visual Resources, of this Draft Supplemental EIR/EIS, for existing and post-project views (from north to south) along the F-B LGA.

The northern terminus of the F-B LGA would be located just north of the city of Shafter, parallel and adjacent to the east side of the BNSF. The alignment would be at-grade and would continue southeast at the Poplar Avenue crossing. Poplar Avenue would be raised in place to cross over SR 43, the BNSF, and the F-B LGA. Beginning near the Poplar Avenue overcrossing, both the BNSF track and the F-B LGA would begin ascending in order to eliminate the existing at-grade crossings in Shafter. The following at-grade crossings would be eliminated: Fresno Avenue,

Shafter Avenue, Central Avenue, and E Lerdo Highway.<sup>5</sup> BNSF and F-B LGA bridges would be constructed at these locations, and in-between the underpasses, the BNSF and F-B LGA alignments would be built on retained fill. A maintenance road access for the F-B LGA alignment would be constructed between the two retained fill embankments. A retaining wall would be constructed along the BNSF/SR 43 right-of-way, and another retaining wall would be built along Walker Street. After crossing E Lerdo Highway, the BNSF profile would be lowered to match the existing track profile at E Los Angeles Avenue, while the F-B LGA would remain on an elevated fill section.

The existing BNSF industry spur adjacent to Commercial Drive would be reconnected from the south, and the F-B LGA alignment would include a bridge to allow the spur to cross underneath. The existing crossing at E Los Angeles Avenue would be closed and traffic routed onto Beech Avenue. The F-B LGA would provide openings/undercrossings at Riverside Street and Cherry Avenue in the city of Shafter. Additionally, Riverside Street would be raised in place to cross over SR 43 and the BNSF, then lowered to match existing elevations, allowing the F-B LGA to cross over. From Cherry Avenue, the F-B LGA would begin to turn east, north of Burbank Street, to the city limits of Shafter. See Figure 2-10, Figure 2-11, and Figure 2-12 for example cross-section views of the F-B LGA within the city of Shafter.

Traction power substations (approximately 32,000 square feet in size) are located along the F-B LGA at approximately 5-mile intervals beginning near E Los Angeles Avenue and continuing south. Stand-alone radio sites (approximately 100 feet tall) are also positioned along the F-B LGA at approximately 2.5-mile intervals, beginning near the intersection of Orange Avenue/Oleander Street and continuing south.

The F-B LGA would turn east along the north side of Burbank Street and then turn southeast at the UPRR. The alignment would continue on embankment until just after crossing the Lerdo Canal. Individual bridges of the F-B LGA alignment would be developed to cross over Driver Road, Zachary Avenue, the Calloway Canal, Zerker Road, and the Friant-Kern and Lerdo Canals. Verdugo Lane would also be left open as a farm road crossing rather than a full roadway opening. North of 7th Standard Road, an F-B LGA aerial structure would be required to accommodate access to existing industries. 7th Standard Road would be raised to cross over the F-B LGA aerial structure, the UPRR, and SR 99. The 7th Standard Road profile increase will require the removal and construction of bridges over the UPRR and SR 99, as well as raising the intersections with Coffee Road and Golden State Avenue. As part of the roadway work, a new on-ramp connection to southbound SR 99 would be added for westbound traffic. Please see Volume III of this Draft Supplemental EIR/EIS, which contains preliminary design plans for the 7th Standard Road/SR 99 interchange.

---

<sup>5</sup> Analysis the Authority conducted shows that five grade separations of rail lines from cross vehicle traffic would adequately maintain present and future-condition traffic circulation in Shafter (Poplar, Fresno, Central, East Lerdo Highway, and Riverside). A sixth grade separation at Shafter Avenue, is not necessary to maintain adequate traffic circulation. It is evaluated in this environmental document for informational purposes only, at the request of Shafter and in attempt to settle litigation (not concluded) Shafter filed in 2014; its inclusion in this document does not commit the Authority to include it in any project the Authority approves at the conclusion of the environmental process. Similarly, Zachary Avenue, Driver Road and Zerker Road are existing north-south roadways the LGA would cross as it traverses between the BNSF and SR-99. The LGA design includes openings under the HSR tracks to allow for the current roadway and Shafter's desired future improvements; however, it is likely that one or more of these three roadways are not required to remain open to maintain adequate circulation. These three openings are included in this environmental document at the request of Shafter and in attempt to settle litigation (not concluded) Shafter filed in 2014; their inclusion in this document does not commit the Authority to their inclusion in any project the Authority approves at the conclusion of the environmental process.

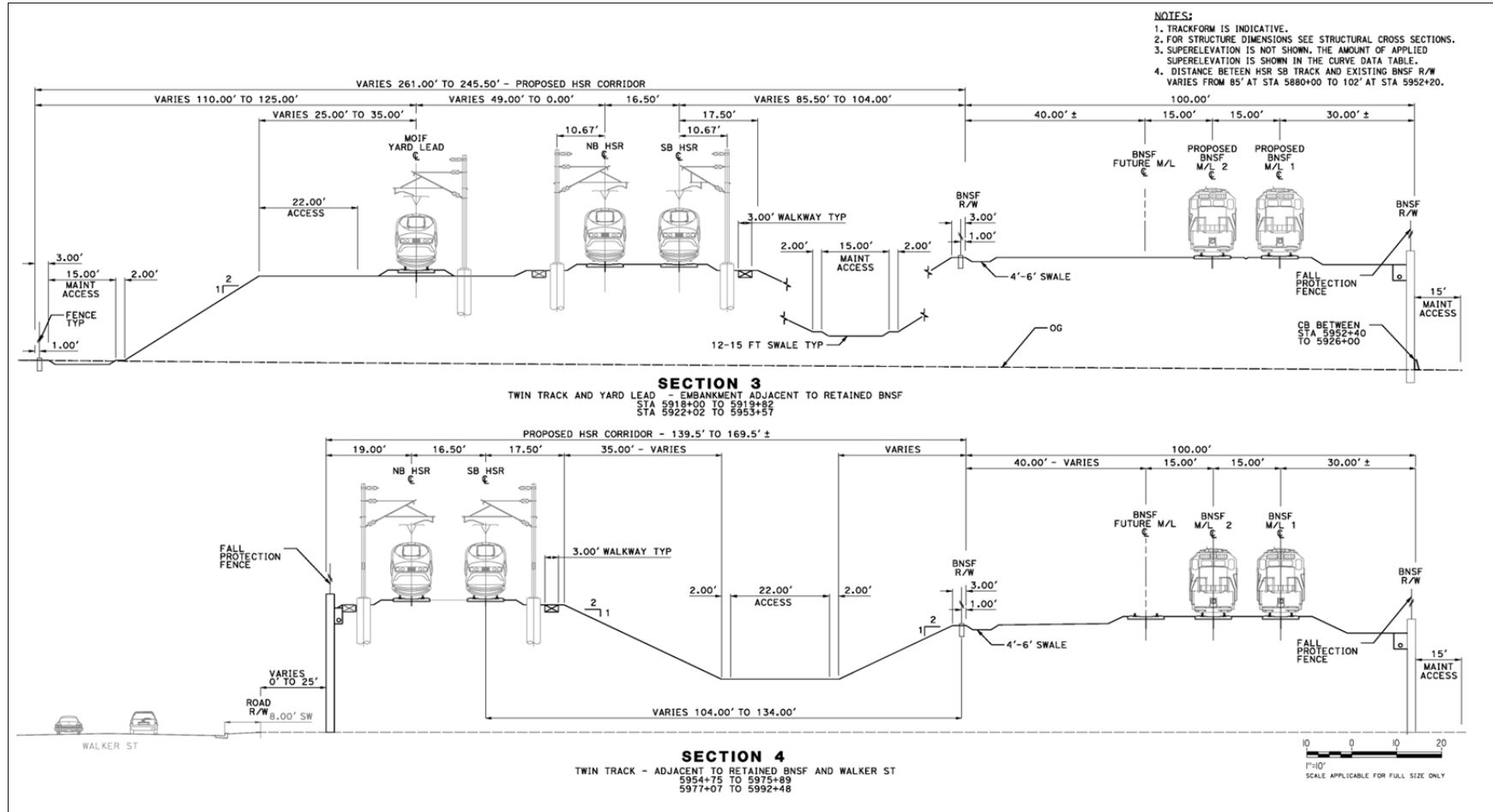

Figure 2-10 Cross-Section of F-B LGA within the City of Shafter

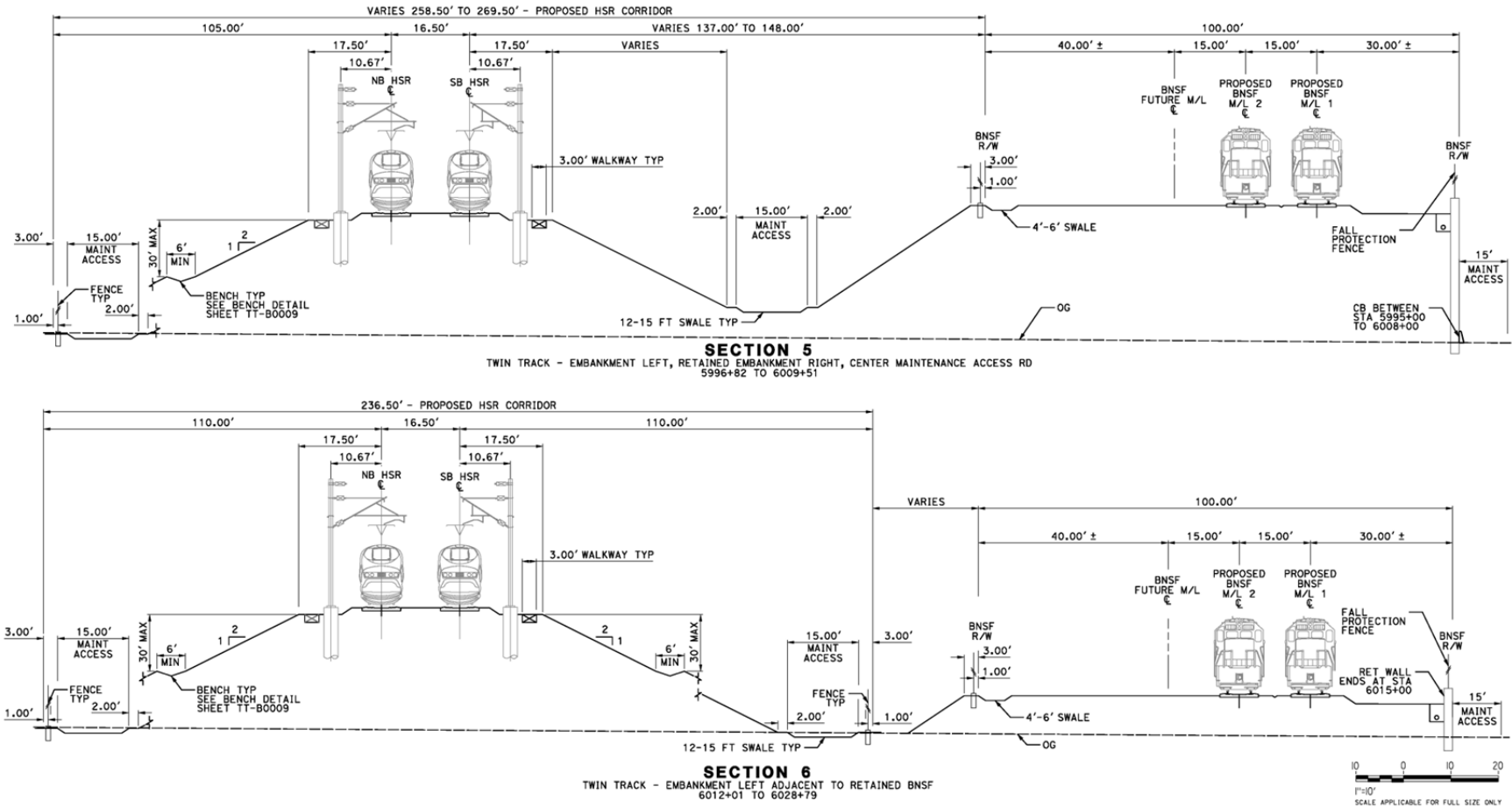
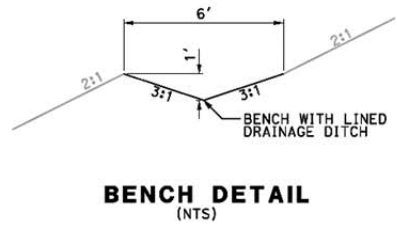
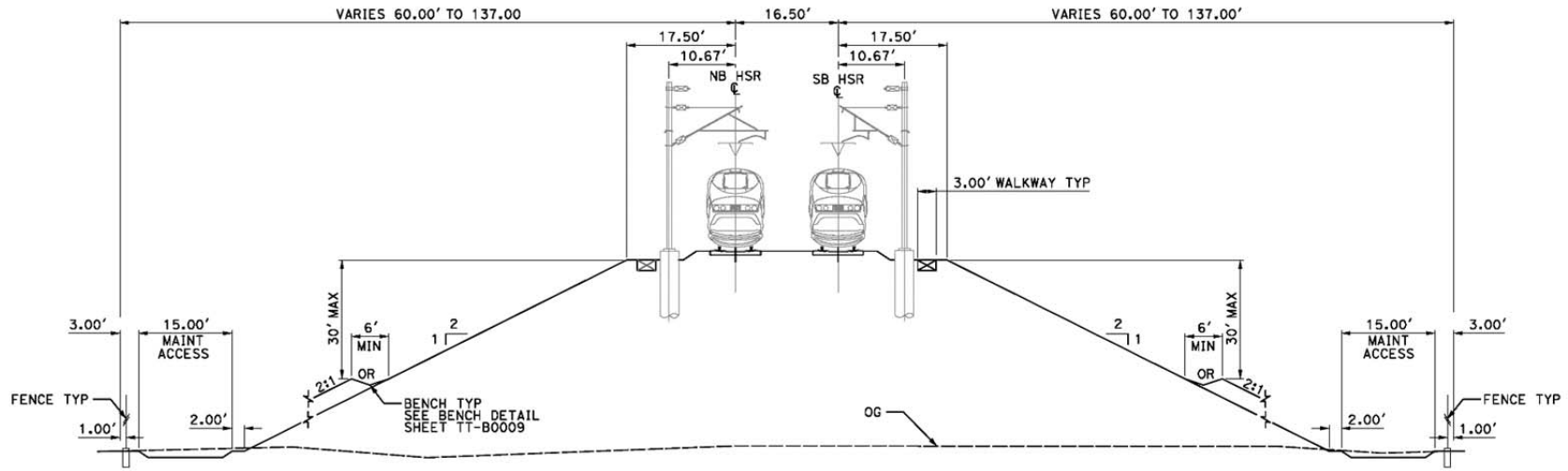

Figure 2-11 Cross-Section of F-B LGA within the City of Shafter North of Los Angeles Avenue



**SECTION 8**  
TWIN TRACK - EMBANKMENT OPEN DRAINAGE

6035+85	TO 6071+00*
6071+00	TO 6074+55
6078+15	TO 6086+00*
6086+00	TO 6096+42
6098+12	TO 6211+53
6212+73	TO 6264+77
6265+97	TO 6329+44
6332+74	TO 6370+55
6371+75	TO 6375+00
6375+00	TO 6420+50*
6420+50	TO 6421+39
6427+09	TO 6470+00*
6470+00	TO 6482+83
6483+23	TO 6513+94
6517+24	TO 6545+00
6673+25	TO 6700+60*

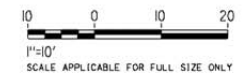

Figure 2-12 Cross-Section of F-B LGA within the City of Shafter at Los Angeles Avenue



Within the city of Bakersfield, the F-B LGA would run generally parallel and adjacent to the UPRR corridor. Throughout the city of Bakersfield, the F-B LGA would be on a viaduct (Figure 2-11). After crossing 7th Standard Road, the alignment would continue southeast over Fruitvale Avenue and then Snow Road. Southwest of the community of Oildale, the F-B LGA would cross over Beardsley Canal, then SR 99, and continue southeast. The F-B LGA would then cross over State Road, Olive Road, and State Road again. On its approach to Airport Drive, the F-B LGA would cross the existing BNSF branch line tracks and continue southeast, paralleling but separated from the UPRR corridor. After crossing Airport Drive, the F-B LGA would run parallel to and east of SR 204.

The F-B LGA would continue southeast on viaduct, crossing over the Calloway Canal, the Kern River, the Carrier Canal, Chester Avenue, 30th Street, M Street, O Street, and Q Street. The alignment would continue southeast until the proposed crossing at SR 178, where the F-B LGA would turn east and would generally run parallel to the UPRR corridor. The alignment would continue southeast, crossing over 24th Street, Sumner Street, and Union Avenue, and would then run down the center of Sumner Street on viaduct. The alignment would continue east on Sumner Street, crossing over Baker Street, Beale Avenue, the BNSF, and UPRR tracks, and Truxtun Avenue. East of Truxtun Avenue, the alignment would continue on viaduct and transition to the north side of the Edison Highway corridor, crossing over connecting streets such as Washington Street, Ogden Street, Chamberlain Avenue, and Mt. Vernon Avenue. Once on the north side of Edison Highway, the highway can be built completely south of the F-B LGA such that connecting streets (e.g., Exchange Street, Webster Street, Quantico Avenue, and California Avenue) would not have to cross under the viaduct. The F-B LGA alignment would terminate near Oswell Street and connect to the HSR alignment in the Bakersfield to Palmdale Project Section.

The alignment would run above Sumner Street and Edison Highway on viaduct. Along these two roads, placement of straddle bents, along with columns in the median of the roadway, would be necessary. The viaduct would be designed to minimize impacts to the local businesses along each roadway. Figure 2-13 shows a cross-section of the F-B LGA viaduct in the city of Bakersfield, which may be implemented within the Sumner Street and Edison Highway corridors. The proposed F-B LGA station evaluated in this Draft Supplemental EIR/EIS would be located at the intersection of F Street/SR 204. This proposed station is discussed in Section 2.4.4.

#### 2.4.4 F-B LGA F Street Station

The currently proposed F-B LGA F Street Station would be located at the intersection of F Street/SR 204 and would be designed per the High-Speed Train Station Area Development: General Principles and Guidelines (Authority 2011). The proposed station would include the typical facilities and services as described in Chapter 2 of the Fresno to Bakersfield Section Final EIR/EIS (pages 2-1 through 2-36) (Authority and FRA 2014).

Table 2-13, Planning and Design Assumptions, in the Fresno to Bakersfield Section Final EIR/EIS Chapter 2 provides information on planning and design assumptions for HSR stations (page 2-73). The discussion is applicable to the F-B LGA F Street Station in Bakersfield. Figure 2-14 and Figure 2-15, respectively, show a proposed rendering and layout of the F-B LGA F Street Station site. The F-B LGA F Street Station would be designed in accordance with the Authority's General Principles and Guidelines (Authority and FRA 2011), and would accommodate the Authority's anticipated ridership for the station (please refer to Section 2.7). Following are the circulation improvements proposed as part of the station plan:

- F Street/SR 204:** The F Street Station Alternative would include access modifications to SR 204 at F Street. The modifications would include elimination of the at-grade intersection of F Street/SR 204. The F Street roadway would be lowered underneath SR 204, and on-ramps and off-ramps would be constructed to and from SR 204. The northbound on-ramps and off-ramps would connect to SR 204 and would drop down to F Street in a standard diamond configuration. The southbound off-ramp would be configured as a loop ramp. The southbound off-ramp would cross over F Street, then turn 180 degrees and connect to F Street, and the on-ramp would share the same intersection with F Street. This configuration on the southbound side of SR 204 allows the existing neighborhood access to remain. The

**This page intentionally left blank**

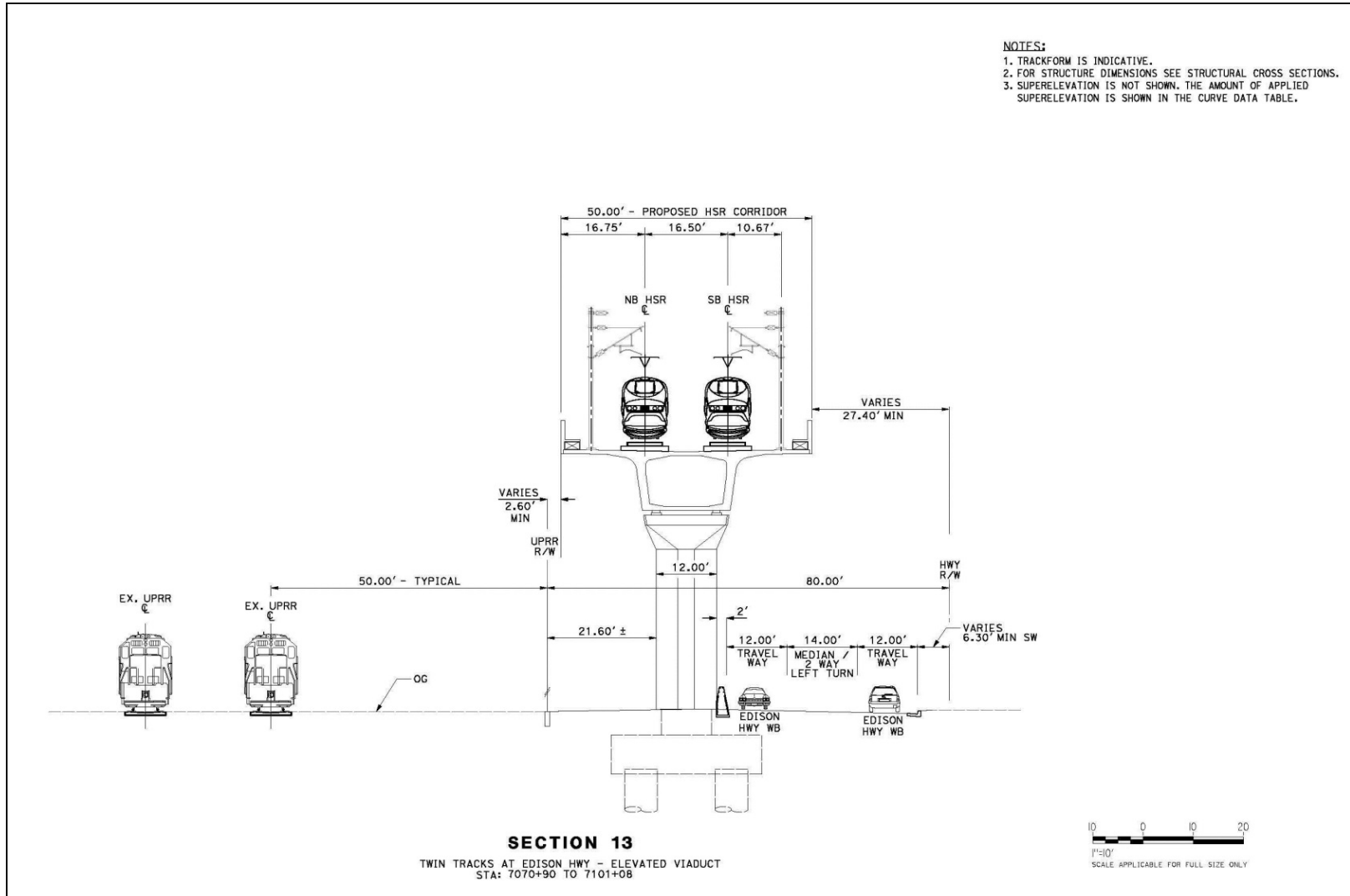

Figure 2-13 Viaduct Cross-Section of the F-B LGA within the City of Bakersfield



Figure 2-14 Bakersfield F Street Station Rendering





Figure 2-15 Bakersfield F Street Station Conceptual Layout

**This page intentionally left blank**



new interchange would eliminate the access ramp from Chester Avenue. Local traffic from Chester Avenue would be required to use F Street to access northbound SR 204. The F Street undercrossing is proposed to be seven lanes wide and would include dual left-turn lanes on northbound F Street. Additionally, a third through lane would be added on F Street between the SR 204 eastbound ramps intersection and 30th Street. This would be accomplished by converting the current two-way left-turn lane on F Street to a dedicated northbound through lane and restricting northbound and southbound left turns on this segment of F Street.

- **Golden State Highway South Frontage Road/F Street:** As part of the Golden State Highway/F Street interchange, the SR 204 South Frontage Road connecting to F Street would be closed on both sides. However, access to the neighborhood that uses the south frontage road would be provided by a new roadway that would tee into the 30th Street/Alder Street intersection.
- **Chester Avenue/34th Street:** This intersection would be realigned, and the west leg would serve as one of the access locations to the station. This would provide signalized full-access to the station.
- **Chester Avenue/32nd Street:** This would be the third access location to the station and would operate as a right-in/right-out-only driveway.
- **Chester Avenue/SR 204 Roundabout:** Due to the construction of the proposed project and the F Street interchange, modifications would be required to two access legs of this roundabout. Both the Golden State North and South Frontage Roads would be closed to accommodate the new F Street interchange ramps.

The entire proposed F Street Station area footprint would be approximately 46 acres and would be located between the UPRR, SR 204, the Carrier Canal, and Chester Avenue. Access to the station would occur from the F Street underpass, the 34th Street overpass, and a right-in/right-out driveway from Chester Avenue. The vehicle circulation from F Street would be organized to maximize separation of flows of private vehicle and public transit circulation to reduce delays of public transit caused by traffic congestion. The existing transit center to the east of F Street provides a convenient connection to Chester Avenue, where the City of Bakersfield plans to construct a future bus rapid transit line. The transit center would also be connected to the primary building of the F Street Station with a dedicated bike/pedestrian walkway that is grade-separated at F Street. This dedicated bike/pedestrian walkway, proposed as part of the F-B LGA, would run the length of the F Street Station site, and would provide bike and pedestrian access between Chester Avenue, the main station building entrance, and the Kern River trail system.

The F-B LGA F Street Station would be designed with two station buildings on approximately 2.2 acres of land. The primary station of the F-B LGA F Street Station would be located on the south side and encompass approximately 78,000 square feet. The secondary station would be located on the north side and encompass approximately 50,000 square feet. Each station building would have three levels: ground, mezzanine, and platform. The ground level of each building would consist of station operation and support rooms in addition to concourse space. The second level (mezzanine) would facilitate passenger circulation to and from the 60 foot-tall platform level. Each station building would open onto an entrance plaza facing SR 204. The primary station plaza would be supported with retail use along the edge and terraced down to meet the F Street connection at its minimum elevation (23 feet below concourse level). The remaining 11.75 acres would be organized into surface and structured parking. Surface parking would be designated on 7 acres with a planned parking capacity of 762 vehicles. Six seven-story parking structures would be located on the station site (on approximately 4.7 acres). The parking structures would include one basement level and a roof deck parking level, and would have total parking capacity for 4,438 vehicles. The total parking capacity (surface parking lots and parking structures) for the station site would accommodate parking for 5,200 vehicles. Finally, the station site would provide 2.8 acres (at the corner of the site where SR 204 crosses over Chester Avenue) that would be dedicated to a landscaped stormwater retention area.

The Amtrak station is located approximately 1 mile south of the proposed F Street Station site. With the introduction of HSR service, it is expected that Amtrak San Joaquin rail service would function as a feeder service to the HSR system in the Fresno to Bakersfield area. This is consistent with the 2008 San Joaquin Corridor Strategic Plan (San Joaquin County 2008), the 2013 California State Rail Plan (Caltrans 2013), and the California HSR Program Revised 2012 Business Plan (Authority and FRA 2012), as discussed in the Fresno to Bakersfield Section Final EIR/EIS. This assumption is also consistent with the 2016 California HSR Business Plan (Authority and FRA 2016). Currently, the Authority, along with state, regional, and local agencies, is engaged in ongoing coordinated planning efforts for connecting regional rail service with the HSR system. These coordinated efforts will help promote economic development, encourage station area development, and enhance multimodal connections between the cities and stations.

#### **2.4.4.1 Maintenance of Infrastructure Facility**

The HSR infrastructure would be maintained from regional MOIFs located at approximately 150-mile intervals. For the F-B LGA, one MOIF is proposed to be located in the city of Shafter between Poplar Avenue and Fresno Avenue (Figure 2-3). MOIFs provide equipment, materials, and replacement parts for the HSR system subdivision. The MOIFs would be sized and outfitted to support the maintenance of infrastructure requirements for 75 miles of HSR track in either direction, supported by a maintenance of infrastructure siding within each 75-mile segment. The 150-mile territory covered by each MOIF would accommodate the time for equipment traveling at 60 miles per hour to reach locations along the alignment during the five-hour nonrevenue maintenance period. The MOIFs would be the locations of regional maintenance machinery servicing storage, materials storage, personnel, and maintenance and administration. Main track access would be accomplished through 45 mile-per-hour turnouts at both ends, ideally located near universal crossover locations (110 miles per hour) to facilitate efficient movement to either main track. The functional requirements of the MOIF sites would include:

- Six yard tracks plus one siding track (1,600 feet in length), totaling approximately 28 acres
- Approximately 8,150 feet of yard track capacity
- Shop facilities for the following activities: MOIF inventory, infrastructure, and equipment maintenance/repair
- Stockpile areas for ballast and other bulk materials, and secured stockpile areas for nonbulk materials
- A rail-side unloading dock and continuous welded rail train storage (1,600 feet), and rail-borne equipment and locomotive storage tracks
- Public access roads to the MOIF and maintenance access roads along the HSR track

Please refer to Chapter 2 of the Fresno to Bakersfield Section Final EIR/EIS (pages 2-15 and 2-16) (Authority and FRA 2014) for more detailed information on MOIF design and requirements.<sup>6</sup>

### **2.4.5 Other Alignment Requirements**

#### **2.4.5.1 Frontage Road and Local Roadway Crossings**

The alignment traveling through rural regions would affect existing local frontage roads used by small communities and farm operations. Where these frontage roads are affected by the HSR alignment, they would be shifted and reconstructed to maintain their function. Where roads would be perpendicular to the proposed HSR system, over crossings or undercrossings would be

<sup>6</sup> In the Fresno to Bakersfield Section Final EIR/EIS, the proposed Shafter MOIF was collocated with the proposed heavy maintenance facility. However, while the proposed Shafter heavy maintenance facility was evaluated in the Fresno to Bakersfield Section Final EIR/EIS, it was not approved; instead the MOIF was approved at that location. Therefore, for the purposes of this Draft Supplemental EIR/EIS, a MOIF site located north of Shafter was evaluated but no heavy maintenance facility site was identified or analyzed as part of the F-B LGA consistent with the comparable portion of the Preferred Alternative (i.e., the "May 2014 Project") used to compare impacts to the F-B LGA.

planned. Technical Appendix 2-A provides a completed listing of roadway crossings associated with the F-B LGA.

Over crossings or undercrossings for the Fresno to Bakersfield Section would be provided approximately every 1 mile or less in many locations due to existing roadway infrastructure. Some roads may be closed in between. For the F-B LGA, the most common use of grade separation from the existing roadways is elevation of the F-B LGA.

Through the city of Shafter, the alignment would run on a raised/retained embankment. Openings in the embankment would be created for existing roadways or roadways that would be rerouted. Additionally, the existing freight train railroad (BNSF) through the city would be elevated to eliminate existing at-grade crossings through downtown Shafter. The existing storage tracks south of East Lerdo Highway would be reconstructed south of East Los Angeles Avenue, and the existing industry spur track near Commercial Drive would be reconnected from the new storage tracks.

Through the city of Bakersfield, the alignment would run primarily on a viaduct structure that would allow the local roadways to pass underneath. Please refer to Chapter 2 of the Fresno to Bakersfield Section Final EIR/EIS (pages 2-1 through 2-15) (Authority and FRA 2014) for a description of the proposed roadway, railroad, and canal crossings for the HSR system that would be applicable to the F-B LGA and the May 2014 Project.

#### **2.4.5.2 Irrigation and Drainage Facilities**

The F-B LGA would affect some existing drainage and irrigation facilities. Depending on the extent of the impact, existing facilities would be modified, improved, or replaced as needed to maintain existing drainage and irrigation functions and to support F-B LGA drainage requirements.

#### **2.4.5.3 Utility Modifications**

Section 2.2.6 of Chapter 2 of the Fresno to Bakersfield Section Final EIR/EIS (Authority and FRA 2014) provides a discussion on traction power distribution, including traction power substations, switching and paralleling stations, and signaling and train-control elements. The following section provides information regarding utility modifications that are anticipated to occur with implementation of the F-B LGA.

In Bakersfield, at the overcrossing of Union Avenue and Sumner Street, proposed alternative locations for the traction power substations have been identified. These alternative locations can receive power from the proposed 230 kilovolt utility switching station located approximately 3,000 feet north along Union Avenue.

The proposed F-B LGA crosses a number of utilities, including but not limited to high-voltage (HV) transmission lines, water conveyance pipelines/canals, natural gas pipelines, and fiber-optic lines. To the extent that it is feasible and reasonable, utilities located within the proposed F-B LGA right-of-way would be relocated to outside of the right-of-way. In the event that additional utility relocations are identified during final engineering design and those relocations are outside of the F-B LGA footprint evaluated in this Draft Supplemental EIR/EIS, additional CEQA, and National Environmental Policy Act review would be conducted for those relocations as necessary. Under the current design of the project, utility relocation would occur within the project footprint identified in Figure 2-3, Figure 2-4, and Figure 2-5. Relocation of utilities would be limited to areas in direct conflict with the F-B LGA construction and right-of-way but may require the complete abandonment or removal and the reconstruction of a utility facility. Modification of existing HV lines and towers within their existing rights-of-way and easements may require temporary HV line bypasses outside their rights-of-way or easements to construct the relocations.

The following provides a summary of the HV transmission tower modifications that are anticipated to occur with implementation of the F-B LGA:

- Modification of existing HV towers would involve raising the overall height of existing HV transmission towers for purposes of raising the power conductors higher to clear over the F-B

LGA in accordance with California Public Utility Commission requirements and Pacific Gas and Electric Company standards. In some cases, this may include relocating HV transmission towers horizontally.

- The preferred HV transmission line relocation methodology would be to modify existing steel lattice type or steel truss type HV transmission towers at their existing locations.
- Existing HV transmission timber poles requiring modification would be replaced with new, taller timber poles or tubular steel poles (TSP) depending on the height adjustment required. The steel lattice towers or steel truss towers that are anticipated to be modified would be evaluated by an Authority engineering contractor (who will be approved by Pacific Gas and Electric Company). Existing tower conditions would be evaluated and a structural analysis performed to evaluate the feasibility of modifying the existing HV transmission towers. Modifications to the existing towers may include strengthening of the steel lattice tower frames by replacement of horizontal members, diagonal members, and vertical members. This may also include adding additional horizontal, diagonal, and vertical bracing members to add overall support for raising portions of the steel space frame or truss. Additional steel framing would be added to the top of the tower to extend the height along with the vertical relocation of the cross arms which support the conductors as necessary.
- Should an HV steel lattice tower or steel truss tower be determined through the evaluation and structural analysis process to be inadequate for modifying, then the tower would be replaced with a new TSP.
- Existing towers located too close to the F-B LGA would be relocated horizontally if any portion of the existing HV transmission tower would impact the F-B LGA viaduct in the event the existing tower should fall over. If the tower is determined to be too close to the F-B LGA, the relocated tower would be placed 200 feet clear of the F-B LGA right-of-way.

HV transmission areas that are anticipated to be affected by implementation of the F-B LGA occur in five locations along the alignment. A brief summary of the location as well as the work anticipated to be completed is discussed below.

#### **Coffee Road, Shafter (115-Kilovolt Line)**

Two HV towers are located perpendicular to Coffee Road in the city of Shafter as shown on Composite Utility Plan drawing UT-C1026. The existing HV towers located east and west of the F-B LGA alignment at this location are approximately 60 feet in height and would be raised in order to clear the F-B LGA alignment. At this HV transmission crossing, it is expected that the existing tower west of the F-B LGA alignment will be relocated west along the south side of Coffee Road to clear the F-B LGA alignment by 200 feet. A new TSP would be installed to replace the existing tower west of the F-B LGA alignment at an increased height. The easternmost existing HV steel lattice tower would be raised to provide additional clearances for the F-B LGA alignment. The HV conductors and first towers that straddle each side of the F-B LGA alignment crossing would also need to be raised. Additionally, the second existing HV tower on the west side of the F-B LGA alignment would be adjusted vertically to accommodate the F-B LGA overcrossing.

#### **7th Standard Road, City of Shafter/Bakersfield, 115-Kilovolt Line (Single Circuit)**

Two HV towers are located parallel to 7th Standard Road in the city of Shafter. The existing HV tower east of the F-B LGA alignment is 80 feet tall, and the existing HV Tower west of the F-B LGA alignment is 110 feet tall. The HV towers located to the east and west of the F-B LGA alignment would need to be raised to clear the F-B LGA alignment. At this HV transmission crossing, the existing steel lattice tower east of the F-B LGA alignment would be removed since the tower is too close to the F-B LGA. The next existing HV transmission tower west of the F-B LGA alignment is a TSP and would serve as the westerly tower that straddles the F-B LGA.

**Southwest of State Route 99 and northeast of Lerdo Canal, City of Bakersfield, 70-Kilovolt Line (double circuit)**

Two HV towers are located on vacant land southwest of SR 99 and northeast of Beardsley Canal in the city of Bakersfield. The existing HV towers located east and west of the F-B LGA alignment are 110 feet tall and would need to be raised in order to clear the F-B LGA. At this HV transmission crossing, the existing steel lattice tower east of the F-B LGA alignment would be removed since the tower is located too close to the F-B LGA. A new HV TSP transmission tower west of the F-B LGA alignment would be constructed and would serve as the westerly tower that straddles the F B LGA alignment. The existing HV transmission steel lattice tower east of the F-B LGA alignment would serve as the easternmost straddle point spanning the F-B LGA alignment. The existing HV transmission steel lattice west of the F-B LGA would be raised so the conductors clear the F-B LGA alignment.

**West/East of State Route 204 Near the Kern County Water Agency Treatment Plant and Kern River, City of Bakersfield, 115-Kilovolt Line (Double Circuit)**

The two HV towers are located east and west of SR 204 on land near the Kern County Water Agency treatment plant, Kern River, and the UPRR in the city of Bakersfield as shown on Composite Utility Plan drawing UT-C1035. The existing HV towers located east and west of the F-B LGA alignment are 110 feet tall and would need to be raised to clear the F-B LGA. At this HV transmission crossing, the first pair of existing steel lattice towers that straddle the F-B LGA alignment on the east and west sides would be raised to provide additional clearances for the F-B LGA alignment.

**Adjacent to Sam Lynn Ball Park and Parallel to Elm Street, City of Bakersfield, 115-Kilovolt/70-Kilovolt Mixed Voltage (Double Circuit)**

Three HV towers are located near Sam Lynn Ball Park, two are located in the proposed F Street Station area, and two are parallel to Elm Street in the city of Bakersfield. The existing HV towers located east and west of the F-B LGA alignment are 110 feet tall and would need to be raised to clear the F-B LGA. At this HV transmission crossing, the existing pair of HV transmission steel lattice towers would be removed from the proposed F-B LGA F Street Station site. To clear the F-B LGA F Street Station site, these towers would be relocated north within the Kern River Parkway area between the SR 204 and the UPRR right-of-way. The HV transmission towers would be TSP-type towers. To accommodate this relocation, two additional pairs of towers would be installed both east and west of the F-B LGA alignment to maintain the double-circuit spacing of the tower runs and provide less impact to the Ball Park. On the west side of SR 204, the first pair of existing steel lattice towers would be removed to accommodate two new TSP HV transmission towers. The towers would be sited to avoid conflicts with Elm Street and the city of Bakersfield/Kern County Water Agency Carrier Canal property, and to avoid impacting the adjacent residential properties. The two additional TSP HV transmission towers east of the F-B LGA F Street Station would be set adjacent to the toe of the Carrier Canal levee. Both new sets of TSP HV transmission towers would be installed approximately 50 to 55 feet higher than the existing steel lattice transmission towers to provide the necessary clearance. The northerly tower line run on the east side of the F-B LGA alignment would be located within the Uplands of the Kern River, which is a resource that would require evaluation under Section 6(f) (please see Chapter 4 of this Draft Supplemental EIR/EIS). The proposed modifications to the towers within the Uplands of the Kern River would be modified by utilizing existing tower foundations, and expanded tower foundation footprints would not be required. Figure 2-16, and Figure 2-17, show tower construction and stringing activities that would occur during utility modifications associated with F-B LGA development.



**This page intentionally left blank**

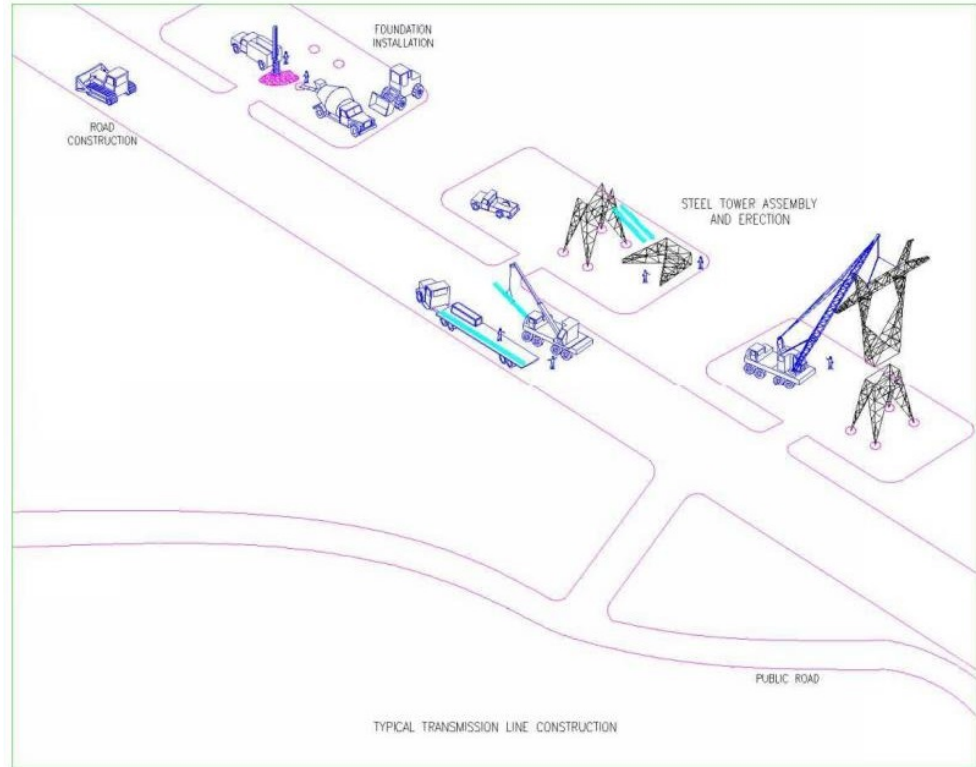

Figure 2-16 Typical Tower Structure Construction

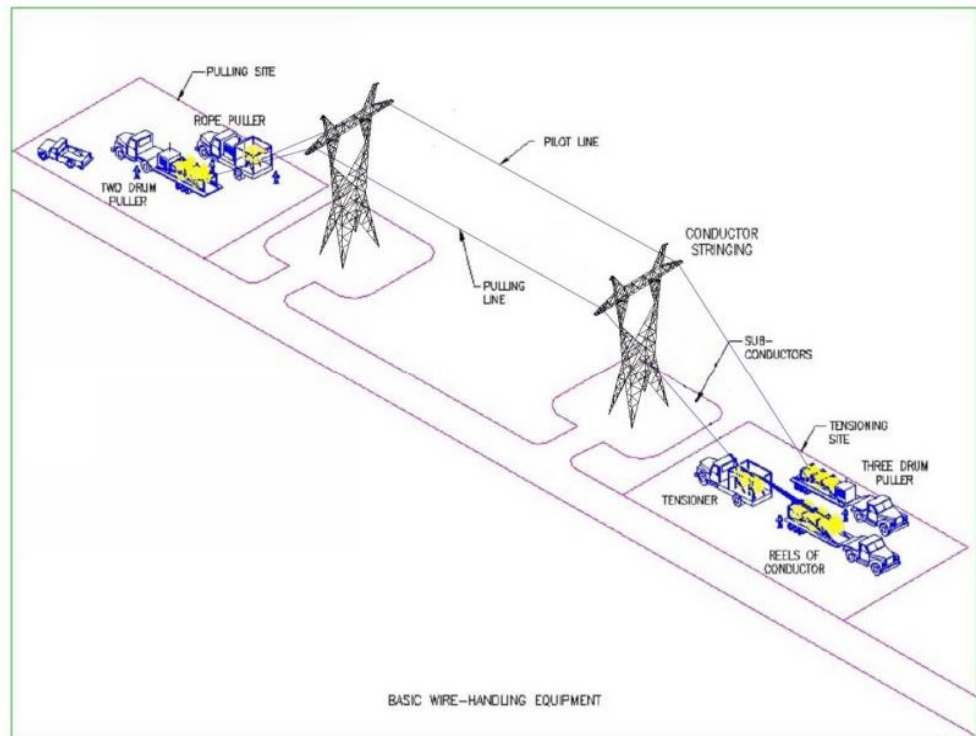

Figure 2-17 Typical Conductor Stringing Activities

#### **2.4.5.4 Natural and Semi-Natural Habitats**

Wildlife crossing opportunities would be available through a variety of engineered structures associated with the Fresno to Bakersfield Section. The F-B LGA does not include any dedicated wildlife crossing structures; however, wildlife crossing opportunities would be available at elevated portions of the alignment, bridges over riparian corridors, road over crossings and undercrossings, and drainage facilities (i.e., large-diameter [60–120 inches] culverts and paired 30-inch culverts).

The Kern River has been identified as a wildlife corridor along the F-B LGA. The Kern River would be spanned by an F-B LGA viaduct with an underside elevation of approximately 45 feet above ground level, which would allow for continued use of the Kern River as a wildlife corridor with minor intrusion.

### **2.5 Modification of California Department of Transportation/State Facilities**

All of the Fresno to Bakersfield Section alternatives would cross state highway facilities. Depending on the F-B LGA guideway type at these crossings, the F-B LGA guideway would require a construction easement, an easement for columns within a state facility, or modification of overcrossings or interchanges. Table 2-14 of the Fresno to Bakersfield Section Final EIR/EIS (page 2-88) (Authority and FRA 2014) identifies the affected facilities and summarizes impacts caused by the HSR alternatives. Figure 2-44 of the Fresno to Bakersfield Section Final EIR/EIS shows the locations of the affected state facilities for each of the HSR alternatives considered in the Fresno to Bakersfield Section Final EIR/EIS.

The F-B LGA would traverse urban, downtown areas in the cities of Shafter and Bakersfield. In doing so, the alignment would cross SR 178 and SR 99, and would parallel SR 204 for 3 miles. At these locations, no significant modification to California Department of Transportation (Caltrans) facilities would occur, as the alignment would cross over each facility. However, easements would be required for the modifications within Caltrans facilities.

#### **2.5.1.1 State Route Reconfigurations**

The alternative alignments evaluated in the Fresno to Bakersfield Section Final EIR/EIS (Authority and FRA 2014) would require reconfigurations to state facilities. A detailed discussion of these reconfigurations and figures showing these reconfigurations are provided in Section 2.4.5.1 of the Fresno to Bakersfield Section Final EIR/EIS (page 2-91).

The F-B LGA, as described above, would require reconfigurations to Caltrans facilities, including the construction of two new interchanges, one at 7th Standard Road/SR 99 and the other at SR 204/F Street. SR 43 in Shafter would be modified due to the removal of the at-grade freight railroad crossings and the addition of new intersections. Modification of the existing pavement markings along SR 99 near Knudsen Drive would be required to provide the proper clearance for F-B LGA columns proposed for placement in the SR 99 median. Existing SR 99 is wide enough that no additional roadway width would be needed to provide the appropriate clearance.

#### **2.5.1.2 State Highway Undercrossings**

In various locations where the F-B LGA alignment is proposed to cross over state highway facilities on viaduct, the possibility of encroachment into Caltrans right-of-way would depend on the specific design and construction methods required. In some cases, temporary closure of the Caltrans right-of-way may be required. Traffic would be detoured onto local streets during such closures.

The F-B LGA, as described above, would pass over SR 178 and SR 99. However, this alignment would not require the development of undercrossings for these state highways.



### **2.5.1.3 Roadway Overcrossings**

As discussed above, Poplar Avenue and 7th Standard Road would cross over the F-B LGA using roadway-overcrossing structures.

### **2.5.1.4 Eliminating an Approach of an At-Grade Intersection**

The elimination of one approach of an existing at-grade intersection with a state highway is deemed necessary where the road is in close proximity to other accessible, proposed overcrossings and/or its existing average annual daily traffic is not high enough to warrant its own overcrossing. In these circumstances, access would be severed along the approach of the intersection traversed by the F-B LGA track. Local traffic would utilize one of the other overcrossings in the vicinity.

### **2.5.1.5 Ramp Modifications**

The F-B LGA would include access modifications to SR 204 at F Street. The modifications would include elimination of the at-grade intersection of F Street/SR 204. The F Street roadway would be lowered underneath SR 204, and on-ramps/off-ramps would be constructed to/from SR 204. This would eliminate the southbound access ramp to and the northbound access from Chester Avenue, and local traffic from Chester Avenue would be required to use F Street to access northbound SR 204. The new ramps along SR 204 would have impacts to two existing bridges on SR 204, the Garces Circle, and Carrier Canal bridges. Both bridges would be widened to accommodate the new access ramps.

The F-B LGA would also include modifications to the existing 7th Standard Road/SR 99 interchange. The modifications would include adding a westbound to southbound loop on-ramp, which would create additional connectivity to the interchange. The other existing ramps would be raised to meet the proposed 7th Standard Road profile.

## **2.6 City and County Roadway Reconfigurations**

The F-B LGA would require the reconfiguration of several city and county roadways. In the city of Shafter, Madera Avenue will be closed with a cul-de-sac at the Shafter MOIF yard. The BNSF and F-B LGA would be on an elevated fill section and would parallel Central Valley Highway (SR 43). A proposed retaining wall would be developed to support the fill adjacent to SR 43. The raised fill would require F-B LGA and BNSF bridges to be constructed at Fresno Avenue, West Shafter Avenue, Central Avenue, and E Lerdo Highway. South of E Lerdo Highway, the BNSF would return to at-grade and the F-B LGA alignment would remain on fill. At E Los Angeles Street, its connection to SR 43 would be closed and would be reconnected to Beech Avenue. Gold Avenue's connection to Riverside Street would be closed with a cul-de-sac at the F-B LGA. Since the remainder of Gold's Avenue is partially unpaved, the unpaved portions would be paved to E Los Angeles Street. As the F-B LGA diverges from the BNSF alignment, the F-B LGA fill would require development of bridges over Cherry Avenue, Driver Road, Zachary Avenue, and Zerker Road. At Verdugo Lane, a farm access box culvert (16 feet by 30 feet) would be provided for continued agricultural access. Orange Avenue E's connection to Cherry Avenue would be modified. Road closures would occur at Orange Avenue E and at Mendota Road (a private road). The portion of Coffee Road north of 7th Standard Road would be realigned to the south of the F-B LGA. Coffee Road would meet the raised 7th Standard Road profile, and Golden State Highway would also be raised to meet the higher 7th Standard Road profile. One access driveway (the adjacent commercial property frontage road) would need to be closed, but the other remaining access driveways would continue to provide service to the businesses.

In the city of Bakersfield just north of SR 99, the F-B LGA would change to a viaduct. After crossing over SR 99, the F-B LGA crosses over State Road's northern terminus and a cul-de-sac would be provided on State Road for an F-B LGA system site. Also, as the F-B LGA crosses over State Road again south of Olive Drive, the roadway would be realigned to pass between the viaduct columns. Further south on State Road near Pierce Road, State Road would be realigned under the viaduct and between viaduct columns. The F-B LGA viaduct in this area would be supported on straddle bents over the realigned roadway. A portion of Nadine Lane (private

roadway) would be used to connect an F-B LGA access road. No modifications to Nadine Lane would be required except to provide a driveway connection. Continuing south, 34th Street would be realigned from approximately L Street to the F Street Station site. To get over the UPRR, the profile of 34th Street would rise to the City of Bakersfield maximum allotted 6 percent grade and Chester Avenue would be raised over the UPRR. K Street and L Street would be modified to meet the new 34th Street profile. To be used as an access road, 32nd Street would be realigned within the F Street Station property, and 24th Street would be closed at Golden State Avenue. Sumner Street would be modified and realigned between Sonora Street to Haley Street and the F-B LGA would curve to parallel the existing street alignment after Haley Street. Sumner Street would be narrowed to support a 12-foot-wide lane and up to an 8-foot-wide shoulder on each side of the viaduct columns. Between viaduct columns along Sumner Street, a raised median would be installed. Inyo Street, Tulare Street, Kern Street, King Street, Owens Street, and Gage Streets would be converted to right-turn-in and out at Sumner Street. Full access would be maintained at Beale Avenue. Miller Street and Haley Street would be closed at Sumner Street by installing cul-de-sacs. The F-B LGA parallels Edison Highway on the south side of the road from Washington Street to just north of Quantico Avenue. Just north of Quantico Avenue, the F-B LGA viaduct would transition to the south side of Sumner Street, to Oswell Street to the south. Steel Avenue would be closed at Edison Highway.

## 2.7 Travel Demand and Ridership Forecasts

The travel demand and ridership forecasts discussed in the Fresno to Bakersfield Section Final EIR/EIS (Authority and FRA 2014) have been applied to the F-B LGA. A brief summary of the ridership forecasts prepared for the Fresno to Bakersfield Section Final EIR/EIS is provided below. For more detailed information on the travel demand and ridership forecasts, please see Chapter 2 of the Fresno to Bakersfield Section Final EIR/EIS (pages 2-101 through 2-105). The ridership data presented below is the same as what was used in the Fresno to Bakersfield Section Final EIR/EIS and is used in this Draft Supplemental EIR/EIS to provide a comparison of effects between the F-B LGA and May 2014 Project.

Ridership forecasts were prepared by the Authority for two scenarios: one assuming full system operation between Sacramento, San Diego, San Francisco, and Anaheim, and one assuming Phase 1 HSR operation between San Francisco, Merced, and Anaheim. The Authority also developed 2035 statewide regional growth estimates and applied these to the 2030 forecasts to develop 2035 forecasts. These forecasts were then used to estimate the ridership levels shown in Table 2-2.

**Table 2-2 HSR System Ridership Forecasts (in millions per year)**

Fare Scenario	2020	2027	2035	
	Phase 1	Full System	Phase 1 <sup>1</sup>	Full System
HSR ticket price = 83% of airfare levels				HSR ticket price = 83% of airfare levels
13.2	47.6	40.2	69.3	13.2

Source: Authority and FRA, 2014. Chapter 2, Table 2-16, page 2-101

<sup>1</sup> Although the full system is expected to be implemented by 2027, these forecasts provide worst-case scenarios for the Phase 1 terminus station and a lower-volume midline station in the full system.

HSR = high-speed rail

As shown in Table 2-2, the range of ridership forecasts for the Fresno to Bakersfield Section is 69.3 million to 98.2 million passengers annually. This range of ridership forecasts allowed for the development of certain aspects of the HSR system design and certain portions of the environmental analysis as described in more detail in Chapter 2 of the Fresno to Bakersfield Section Final EIR/EIS (pages 2-1 to 2-36) (Authority and FRA 2014). Eventual HSR system ridership will depend on many uncertain factors, such as the price of gasoline or the eventual cost

of an HSR ticket. Accordingly, the HSR system, including the F-B LGA, is designed to accommodate the broad range of future ridership over the coming decades.

The analysis presented above is based on an assumed 188 train trips in the daytime and 37 trips at night for a total of 225 trains per day. There would be approximately 24 peak-hour trains.

## 2.8 Operations and Service Plan

The Operations and Service Plan discussed in the Fresno to Bakersfield Section Final EIR/EIS would be applicable to the F-B LGA, with updates per the 2016 Business Plan (Authority 2016). Phase 1 of the Operation and Service Plan would connect the Silicon Valley to the Central Valley by 2025, and would connect San Francisco with Los Angeles via the initial Central Valley section by 2029. HSR service during Phase 2 would extend to Sacramento and San Diego starting after 2029. The HSR would offer express, limited-stop, and all-stop services, depending on the time of the day and projected needs. For Phases 1 and 2 there would be 24 HSR stations; up to three HSR stations would be located within the Fresno to Bakersfield Section. There is one proposed station in the F-B LGA. By 2035, multiple facilities for overnight storage, inspection, and routine maintenance of over 200 trainsets, each 656 feet long would be required. One MOIF would also be required approximately every 100 miles.

For more information on the Operations and Service Plan, please see Chapter 2 of the Fresno to Bakersfield Section Final EIR/EIS (pages 2-103 through 2-107) (Authority and FRA 2014) and the 2016 Business Plan (Authority 2016).

## 2.9 Maintenance Activities

The Authority would regularly perform maintenance along the F-B LGA track and railroad right-of-way as the power systems, train control, signaling, communications, and other vital systems required for the safe operation of the HSR system. Maintenance methods are expected to be similar to those of existing European and Asian HSR systems, adapted to the specifics of the California HSR. However, the FRA will specify the standards of maintenance, inspection, and other items in a set of regulations (Rule of Particular Applicability) to be issued in the next several years, and the overseas practices may be amended in ways not currently foreseen. The brief descriptions of maintenance activities described below are thus based on best judgement about future practices in California.

- Track and Right-of-Way:** The track at any point would be inspected several times per week using measurement and recording equipment aboard special measuring trains. These trains would be similar in design to the regular trains but would operate at a lower speed. The special trains would run between midnight and 5:00 a.m. and would usually pass over any given section of track once in the night.

Most adjustments to the track and routine maintenance would be accomplished in a single night at any specific location with crews and material brought by work trains along the line. When rail resurfacing (i.e., rail grinding) is needed, perhaps several times per year, specialized equipment would pass over the track sections at 5 to 10 miles per hour.

Approximately every four to five years, ballasted track would require tamping. This more intensive maintenance of the track uses a train with a succession of specialized cars to raise, straighten, and tamp the track, using vibrating “arms” to move and position the ballast under the ties. The train would typically cover a mile-long section of track in the course of one night’s maintenance. Slab track, which is expected to comprise track at elevated sections, would not require this activity. No major track components are expected to require replacement through 2035.

Other maintenance of the right-of-way, aerial structures, and bridge sections of the alignment would include drain cleaning, vegetation control, litter removal, and other inspection that would typically occur monthly to several times a year.

- Power:** The overhead contact system along the right-of-way would be inspected nightly, with repairs being made when needed. This would typically be accomplished in one night’s



maintenance window. Other inspections would occur monthly. Many of the functions and status of substations and smaller facilities outside of the trackway would be remotely monitored; however, visits would be made to repair or replace minor items, and would also be scheduled several times per month to check the general site. It is expected that no major component replacement would be required for the overhead contact system or the substations through 2035.

- **Structures:** Visual inspections of the structures along the right-of-way and testing of fire and life-safety systems and equipment in or on structures would occur monthly, while inspections of all structures for structural integrity would occur at least annually. Steel structures would also require painting every several years. For tunnels and buildings, repair and replacement of lighting and communication components would be performed on a routine basis. It is expected that no major component replacement or reconstruction of any structures would be needed through 2035.
- **Signaling, Train Control, and Communications:** Inspection and maintenance of signaling and train control components would be guided by FRA regulations and standards to be adopted by the Authority. Typically, physical in-field inspection and testing of the system would occur four times per year using hand-operated tools and equipment. Communication components would be routinely inspected and maintained, usually at night, although daytime work may occur if the work area is clear of the trackway. No major component replacement of these systems is expected through 2035. Several system site locations require access from private roads.
- **Station:** The F Street Station would be inspected and cleaned daily. Inspections of the structures, including the platforms, would occur annually, consistent with the maintenance activities described in the Fresno to Bakersfield Section EIR/EIS (pages 2-106 and 2-107) and in accordance with the regime developed between the Authority and contracted maintainer. Inspections of other major systems, such as escalators, the heating and ventilation system, ticket-vending machines, and closed-circuit television would be according to manufacturer recommendations. Major F Street Station components are not expected to require replacement through 2035.
- **Perimeter Fencing and Intrusion Protection:** Fencing and intrusion protection systems will be remotely monitored as well as periodically inspected. Maintenance would occur as needed, but it is not expected that the fencing or systems would require replacement before 2035.

## 2.10 Construction Plan and Phased Implementation Strategy

The Construction Plan and Phased Implementation Strategy discussed in the Fresno to Bakersfield Section Final EIR/EIS (Authority and FRA 2014) will be applicable to the F-B LGA. The general approach to building the HSR system, including activities associated with preconstruction and construction of major system components, and the Authority's phased implementation strategy are summarized in Chapter 2 of the Fresno to Bakersfield Section Final EIR/EIS (pages 2-113 through 2-119).

As discussed in Section 2.8 of the Fresno to Bakersfield Section Final EIR/EIS (page 2-113), the project would be built using a "design-build" (D/B) approach. This method of project delivery involves a single contract with the project owner to provide design and construction services. This differs from the "design-bid-build" approach, where design and construction services are managed under separate contracts and the design is completed before the project is put out for construction bids. The D/B approach offers more flexibility to adapt the project to changing conditions. The contract with the D/B contractor will require compliance with standard engineering design and environmental practices and regulations as well as implementation of any project design features and applicable mitigation measures included in this Draft Supplemental EIR/EIS.

During final design, the Authority and its contractor would conduct a number of pre-construction activities to determine how best actual construction should be staged and managed. As described

in Section 2.8.2, Pre-Construction Activities, of the Fresno to Bakersfield Section Final EIR/EIS (page 2-116), these activities would include identifying construction staging areas and pre-casting yards, which would be needed for the casting, storage, and preparation of precast concrete segments, temporary spoil storage, workshops, and the temporary storage of delivered construction materials. Field offices and/or temporary jobsite trailers would also be located at the staging areas. Following construction, staging and laydown areas would be restored to previous condition.

The processes by which the F-B LGA and May 2014 Project would be constructed are similar; however, the main differences between the F-B LGA and the May 2014 Project with regard to the Construction Plan and Phased Implementation Strategy are as follows:

- **Raising the BNSF through Shafter**
  - The proposed raised portion would require the BNSF to be temporarily relocated on a shoofly alignment.
- **The placement of the HSR alignment down the center of Sumner Street and Edison Highway**
  - The May 2014 Project alignment analyzed in the Fresno to Bakersfield Final EIR/EIS (Authority and FRA 2014) was sited adjacent to existing transportation corridors and not within, as with the F-B LGA.
  - The F-B LGA was developed in coordination with City of Bakersfield and Kern County representatives during Technical Working Group meetings, and in an attempt to reduce impacts, places the HSR corridor within the existing rights-of-way of Sumner Street and Edison Highway.
  - Construction of the F-B LGA would require a temporary shutdown/detour of existing traffic along Sumner Street and Edison Highway.
- **Access to the May 2014 Project Station versus the F-B LGA F Street Station**
  - Access to the May 2014 Project Station location (Truxtun Avenue) would not significantly change the roadways from existing conditions. At-grade driveway access points were from the existing street system.
  - Access to the F-B LGA F Street Station would require a new interchange on SR 204, an F Street undercrossing at SR 204, and improvements to Chester Avenue and 34th Street to provide secondary access.
  - Construction of the roadway improvements associated with the F-B LGA F Street Station would require a shutdown and detouring of traffic for periods of two to three months for up to 15 months at a time.

Construction of the HSR system began in January 2015. The Silicon Valley to Central Valley line is expected to be completed by 2024 and begin offering passenger service by 2025 as described in the 2016 Business Plan.

The 2016 Business Plan developed and adopted by the Authority on May 1, 2016, presents the business model for how the Silicon Valley to Central Valley HSR line will be delivered and operated. The 2016 Business Plan discusses phased implementation of the HSR system with Phase 1 extending from San Francisco to Los Angeles by 2040<sup>7</sup> and Phase 2 consisting of extensions from Merced to Sacramento and from Los Angeles to San Diego via the Inland Empire.

<sup>7</sup> It should be noted that Phase 1 would include development of the HSR system to Bakersfield.

## 2.11 Authority's Adopted Requirements Applicable to the F-B LGA

The FRA and the Authority prepared a joint Fresno to Bakersfield Section Project Final EIR/EIS, which included an MMEP. The adopted MMEP included a table of mitigation measures and a table of avoidance and minimization measures that were applicable to the alternatives evaluated in the Fresno to Bakersfield Section Final EIR/EIS. The MMEP (as amended) has been included as Appendix 2-G of this Draft Supplemental EIR/EIS, and all of the avoidance and minimization measures that are identified are applicable to the F-B LGA and are discussed, as appropriate, for each resource topic in Chapter 3. Appendix 2-H describes how the avoidance and minimization measures applicable to the F-B LGA minimize and avoid significant effects.

## 2.12 Permits and Approvals

The Authority and the FRA have prepared, or are in the process of preparing, agreements with environmental resource agencies to facilitate the environmental permitting required during final design and construction. These agreements—a memorandum of understanding and a memorandum of agreement or programmatic agreement—will clearly identify the Authority's responsibilities in meeting the permitting requirements of the federal, state, and regional environmental resource agencies. For example, a memorandum of agreement was established in 2010 among the Authority, the FRA, the U.S. Army Corps of Engineers, and the U.S. Environmental Protection Agency (Authority et al. 2010) regarding integration of the National Environmental Policy Act, Clean Water Act Section 404, and Rivers and Harbors Act Section 14 processes. Table 2-3 lists the major environmental permits and approvals required for the HSR project that are potentially applicable to the F-B LGA. This table identifies each agency's status as a National Environmental Policy Act cooperating agency or CEQA responsible agency. As a state agency, the Authority is exempt from local permit requirements; however, in order to coordinate construction activities with local jurisdictions, the Authority would seek local permits as part of construction processes consistent with local ordinances. The agencies identified in Table 2-3 are anticipated to rely on the Fresno to Bakersfield Section Final EIR/EIS (Authority and FRA 2014) and this Draft Supplemental EIR/EIS to support their permitting and approval processes.



**Table 2-3 Major Environmental Permits and Approvals**

Agency	Permit
<b>Federal</b>	
U.S. Army Corps of Engineers (NEPA cooperating agency)	Section 404 Permit for Discharge of Dredged or Fill Materials Into Waters of the U.S.
U.S. Bureau of Reclamation	Permits to Enter; Temporary Construction Permits; Acquisition of Land Rights
U.S. Department of Transportation	Section 4(f) of the U.S. Transportation Act of 1966
U.S. Department of the Interior/National Park Service	Section 6(f) of the Land and Water Conservation Fund Act of 1965
U.S. Advisory Council on Historic Preservation via the California State Historic Preservation Office	Section 106 Consultation (National Historic Preservation Act of 1966)
U.S. Environmental Protection Agency	Review of Environmental Justice Conclusions; General Conformity Determination
U.S. Fish and Wildlife Service	Section 7 Consultation and Biological Opinion
Surface Transportation Board (NEPA cooperating agency)	Authority to construct and operate new rail line
<b>State</b>	
California Department of Fish and Wildlife (CEQA responsible agency)	California Endangered Species Act Permits California Department of Fish and Wildlife Section 1602 Lake and Streambed Alteration Agreement Use of Title 14 Lands
Caltrans (CEQA responsible agency)	Caltrans Encroachment Permits
California Public Utilities Commission (CEQA responsible agency)	Approval for construction and operation of railroad crossing of public road and for construction of new transmission lines and substations
California State Lands Commission (CEQA responsible agency)	Lease for crossing state sovereign lands
State Water Resources Control Board, Central Valley Regional Water Quality Control Board (CEQA responsible agencies)	Clean Water Act Section 401 Water Quality Certification Section 402 National Pollutant Discharge Elimination System Water Discharge Permit Dewatering Permit (Order No. 98-67) Spill Prevention, Control, and Countermeasure Plan (part of Section 402 process) Stormwater Construction and Operation Permit
Central Valley Flood Protection Board (CEQA responsible agency)	California Code of Regulations, Title 23, Section 2, and Code of Federal Regulations, Title 33, Section 208.10 (flood protection facilities)
<b>Regional</b>	
San Joaquin Valley Air Pollution Control District (CEQA responsible agency)	Rule 201, General Permit Requirements; Rule 403, Fugitive Dust; Rule 442, Architectural Coatings; Rule 902, Asbestos; and Rule 9510, Indirect Source Review

Caltrans = California Department of Transportation  
CEQA = California Environmental Quality Act

NEPA = National Environmental Policy Act  
U.S. = United States

**This page intentionally left blank**