

California High-Speed Train Project



TECHNICAL MEMORANDUM

Traction Power Simulations

Initial Segment – Anaheim to Sylmar

TM 3.1.3.1

Prepared by: Signed document on file _____ 04 Jun 09
E. Cazaudebat Date

Checked by: Signed document on file _____ 04 Jun 09
Eric Scotson Date

Approved by: Signed document on file _____ 04 Jun 09
Ken Jong, PE, Engineering Manager Date

Released by: Signed document on file _____ 19 Jun 09
Anthony Daniels, Project Director Date

Revision	Date	Description
0	04 Jun 09	Initial Release

Note: Signatures apply for the latest technical memorandum revision as noted above.

This document has been prepared by **Parsons Brinckerhoff** for the California High-Speed Rail Authority and for application to the California High-Speed Train Project. Any use of this document for purposes other than this Project, or the specific portion of the Project stated in the document, shall be at the sole risk of the user, and without liability to PB for any losses or injuries arising for such use.

System Level Technical and Integration Reviews

The purpose of the review is to ensure:

- Technical consistency and appropriateness
- Check for integration issues and conflicts

System level reviews are required for all technical memorandums. Technical Leads for each subsystem are responsible for completing the reviews in a timely manner and identifying appropriate senior staff to perform the review. Exemption to the system level technical and integration review by any subsystem must be approved by the Engineering Manager.

System Level Technical Reviews by Subsystem:

Systems: NOT REQUIRED _____
 Print Name: _____ Date _____

Infrastructure: NOT REQUIRED _____
 Print Name: _____ Date _____

Operations: NOT REQUIRED _____
 Print Name: _____ Date _____

Maintenance: NOT REQUIRED _____
 Print Name: _____ Date _____

Rolling Stock: NOT REQUIRED _____
 Print Name: _____ Date _____

Note: Signatures apply for the technical memorandum revision corresponding to revision number in header and as noted on cover.

TABLE OF CONTENTS

1.0	SCOPE OF THIS REPORT	1
2.0	DESCRIPTION OF THE LA UNION STATION AREA	2
3.0	GENERAL DESCRIPTION OF THE TRACTION POWER SYSTEM.....	4
3.1	MAIN PERFORMANCES OF THE POWER SYSTEM	4
3.2	HIGH VOLTAGE FEEDING DESCRIPTION	4
3.3	TRACTION POWER DESCRIPTION.....	4
3.4	OVERHEAD CONTACT SYSTEM (OCS).....	5
4.0	MAIN HYPOTHESES.....	6
4.1	TRACTION POWER HYPOTHESES.....	6
4.1.1	Land Acquisition to Install the Traction Power Supply Station, Switching Station and Paralleling Stations.....	6
4.1.2	SCE or LADWP High Voltage Lines and Substations.....	6
4.1.3	Feeding Configuration Used for the Traction Power Simulation.....	8
4.1.4	Electrical Characteristics of the SST and PS Used for the Traction Power Simulation.....	11
4.1.5	Wire Characteristics Used for the Traction Power Simulation.....	11
4.2	ROLLING STOCK HYPOTHESES	13
4.2.1	General Rolling Stock Information.....	13
4.2.2	Rolling Stock Data Used for the Traction Power Simulation	16
4.3	OPERATION ON SYLMAR - LA UNION STATION - ANAHEIM LINE	18
4.3.1	Speed Limitations	18
4.3.2	Operating Plan Used for the Traction Power Simulation with 20 Trains per Hour	19
4.3.3	Operating Plan Used for the Traction Power Simulation with 16 Trains per Hour	21
5.0	ELECTRICAL SIMULATION – RESULTS, ANALYSIS AND CONCLUSIONS.....	23
	APPENDIX 1: EXAMPLE OF TRAIN SPEEDS	25
	APPENDIX 2: SIMULATION RESULTS FOR 20 TRAINS PER HOUR.....	26
	APPENDIX 3: SIMULATION RESULTS FOR 16 TRAINS PER HOUR.....	34

GLOSSARY

ACSR	Aluminium Conductor Steel Reinforced
AEC	Aerial Earth (Ground) Conductor
AT	Autotransformer
Bz	Bronze
BEC	Buried Earth (Ground) Conductor
CHSTP	California High-Speed Train Project
Cu	Copper
CW	Contact Wire
EMC	Electro Magnetic Compatibility
EMI	Electro Magnetic Interference
GIS	Gas Insulated Switch
HV	High Voltage
KP	Kilometric Point
LA	Los Angeles
LADWP	Los Angeles Department of Water and Power
LV	Low Voltage
MW	Messenger Wire
NF	Negative Feeder
OCS	Overhead Contact System
PS	Paralleling Station (with Autotransformer)
SCE	South California Edison
SWS	Switching Station (with Autotransformers)
SST	Traction Power Supply Station (with HV Utility Supply)

1.0 SCOPE OF THIS REPORT

The aim of this traction power simulation report is to give, with the current hypothesis, including traffic patterns of 20 and 16 trains per hour and per direction between Sylmar and Redondo Junction, and 7 and 6 trains per hour and per direction between Redondo Junction and Anaheim, an assessment of the needs for the traction power supply of the High Speed Line between Sylmar and LA Union Station, and between LA Union Station and Anaheim.

In order to minimize EMC problems along the line and the number of substations, the line will be fed in **2 x 25 kV, 60 Hz**, in accordance with the Technical memorandum 3.1.1.1 “Traction Power 2x25kV Autotransformer Electrification System & Supply Voltages.”

2.0 DESCRIPTION OF THE LA UNION STATION AREA

The area of the study is:

- The line between LA Union station and Anaheim, also called the LOSSAN corridor, which has been chosen by the California HSRA as the southern end of the Initial Phase from Anaheim to San Francisco. See figure 1. This line includes the Redondo junction which is the exit towards the San Diego line.
- The line coming from Sylmar down to LA Union Station. See figure 2.

The extension from Anaheim to Irvine is not decided yet but should be considered when addressing the power sizing of the line. Indeed, whilst at this point in time, the simulation has not been carried out between Anaheim and Irvine, one of the Traction Power Supply Station (SST) has been located to be able to feed up to Irvine.



Figure 1: LOSSAN Corridor - Los Angeles to Anaheim Line



Figure 2: Sylmar to LA Union Station Line

3.0 GENERAL DESCRIPTION OF THE TRACTION POWER SYSTEM

3.1 MAIN PERFORMANCES OF THE POWER SYSTEM

The OCS voltage drop shall be in accordance with IEC 60850 “Supply voltages of traction systems,” whose main voltage criteria are as follow:

- Operating nominal voltage: 25.0 kV
- Highest permanent voltage U_{max1} : 27.5 kV
- Highest non-permanent voltage U_{max2} : 29.0 kV
- Lowest permanent voltage U_{min1} : 19.0 kV
- Lowest non-permanent voltage U_{min2} : 17.5 kV

3.2 HIGH VOLTAGE FEEDING DESCRIPTION

With regards to power demands (especially at peak hours), it is better to connect traction substations to the 230 kV, 60 Hz or 500 kV, 60 Hz SCE network rather than to the lowest acceptable Utility supply voltage of 115kV

The traction substation must be fed from 2 different HV lines, to ensure traction substation power availability under Utility contingency power supply conditions.

3.3 TRACTION POWER DESCRIPTION

The main principle of the 2x25 kV system is shown in the figure below:

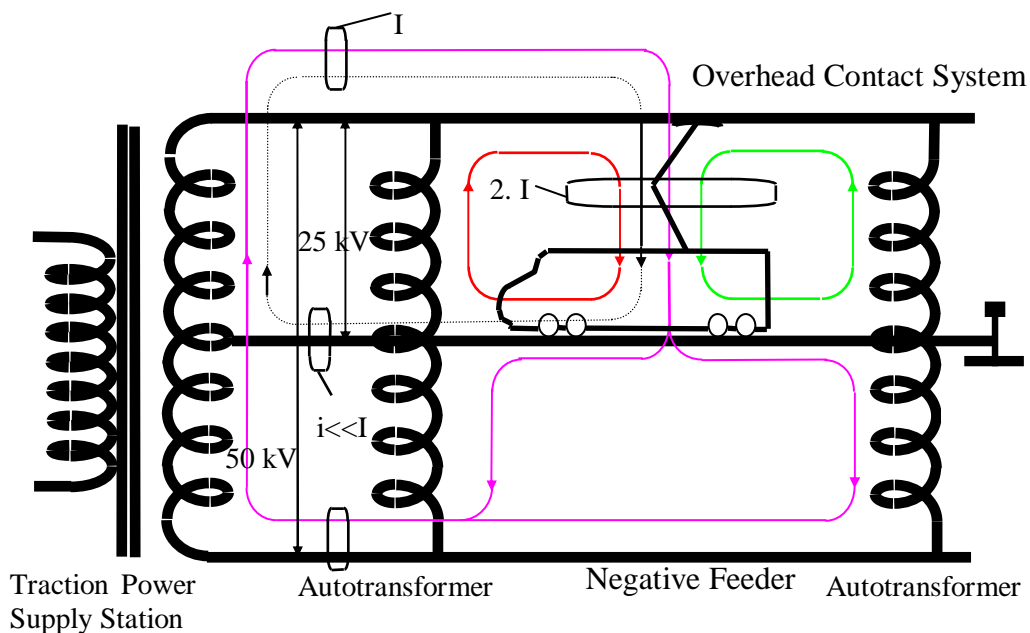

Figure 3: 2 x 25 kV principle

The system main components are:

- 2 x 25 kV Traction Power Supply Stations (fig. 4) with a nominal output voltage of 50 kV.
- Paralleling Stations with 1 Autotransformer (2 autotransformers may be useful in special cases)
- Switching Stations (with Autotransformers)
- Phase break separation sections adjacent to traction power supply stations and switching stations.

The Traction Power Supply Station should be designed with two (2) power transformers each rated for the full load of the supply station for redundancy purposes.

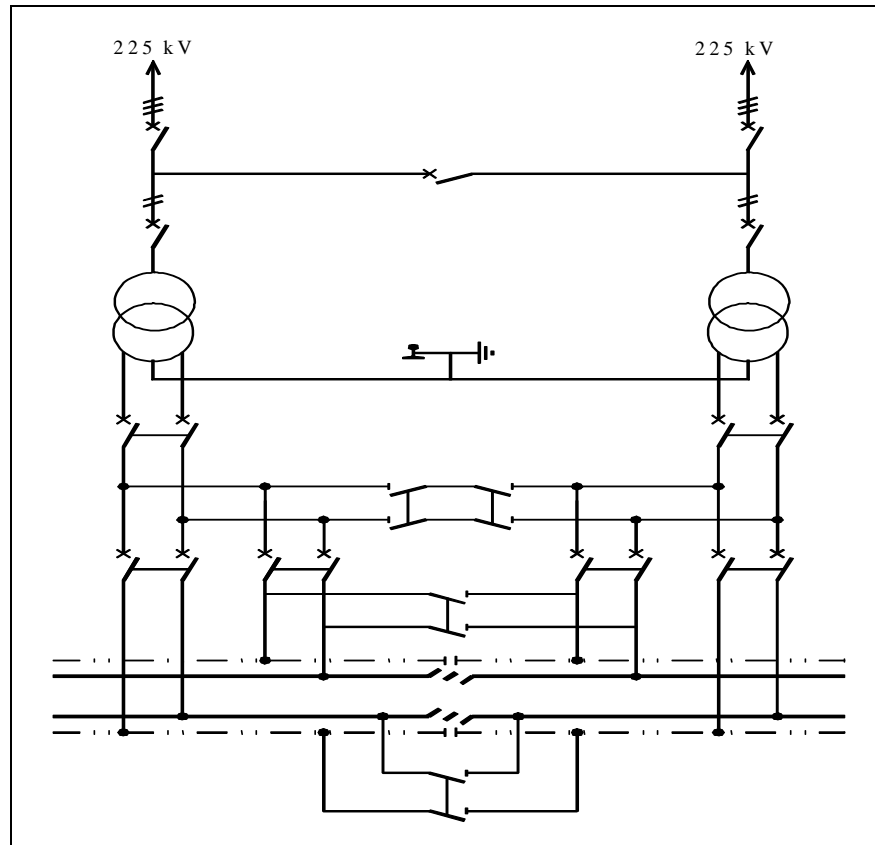

Figure 4: 2x25 kV Traction Power Supply Station principle

3.4 OVERHEAD CONTACT SYSTEM (OCS)

The OCS technology considered for the simulation is similar to that used on high-speed rail lines in France. A detailed description of the assumptions is included in Section 4.0 Main Hypotheses. Regarding phase break separation sections. A minimum length of 5,000 feet (1500 m) of track length, preferable without grade change, and on an alignment with a curve radius greater than 5,300 feet (1600 m) is needed to install a high speed phase break. The “without grade change constraint is due to the fact that the train should run under this phase break separation section without its power on, assuming that the design of the Technical Specification for Interoperability of European High Speed Lines applies. Further studies would need to be conducted to assess requirements of other phase break separation designs (Japanese design for example).

4.0 MAIN HYPOTHESES

4.1 TRACTION POWER HYPOTHESES

4.1.1 Land Acquisition to Install the Traction Power Supply Station, Switching Station and Paralleling Stations

In a first approach the possible sites to install the traction power supply station (SST) between LA Union Station and Anaheim include:

- Near Anaheim station
- Near Norwalk station

The possible sites to install the traction power supply station (SST) North of LA Union passenger station include a theoretical location, four (4) miles north of LA Union Station, which is based on the theoretical spacing of nominally 30 miles between 2x25 kV traction power supply stations.

Possible sites to install the switching station (SWS) and paralleling stations (PS) between LA Union Station and Anaheim include:

- Near Highway 710 and Bandini Boulevard for the SWS,
- Along the river, near Sycamore Street PS,
- Near Carmenita Road and Rosecrans Avenue PS,
- Along the existing railroad and Dale Street in Fullerton PS,
- Along the existing railroad and East La Palma Avenue PS.

The possible sites to install the switching stations (SWS) and paralleling stations (PS) North of LA Union Station have not been specifically sited, and are based on the theoretical spacing of a SWS at mid-distance between the Traction Power Supply Stations, and 5 mile spacing between paralleling stations.

4.1.2 Southern California Edison (SCE) or Los Angeles Department of Water and Power (LADWP) High Voltage Lines and Substations

At the present time, we are still collecting required information regarding the SCE and LADWP 115, 230 kV and 500 kV networks. This information will be included in TM 3.1.5.3 "Utility Power Supply Based on information collected to date, there are 2 main SCE substations identified, close to Anaheim station, as shown on figure 5 next page.

With further SCE and LADWP coordination, we will be able to confirm locations of the 230 kV lines, if the respective source substations have power available, and if it is possible to have dedicated HV lines to supply the CHSTP Traction Power Supply Stations, or be on a 230 kV loop fed by two different high voltage utility substations.

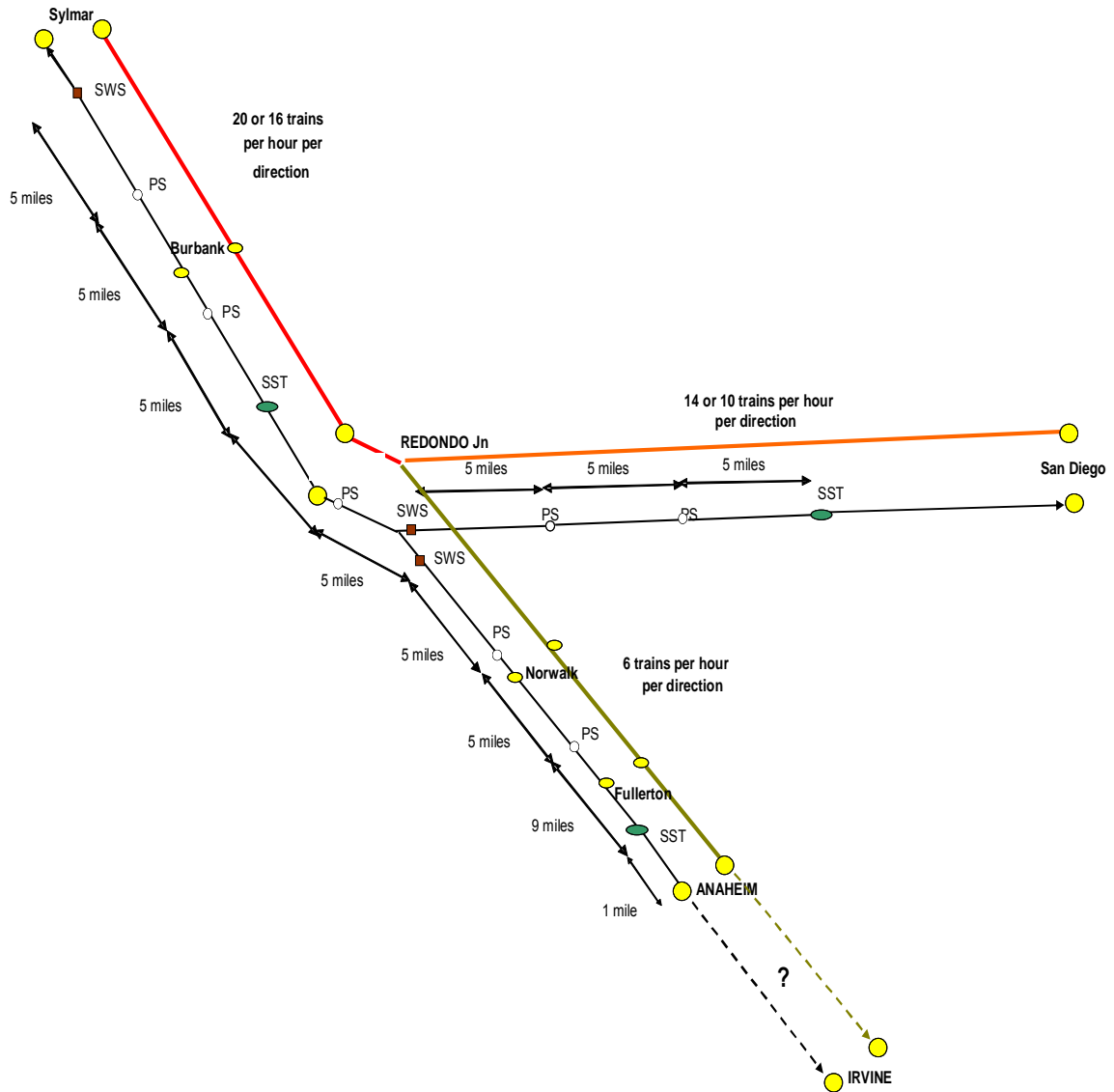

Figure 5 : Possible locations of the Traction Power Supply Station and Paralleling Stations between LA and Anaheim

4.1.3 Feeding Configuration Used for the Traction Power Simulation

For the purposes of traction power simulation modeling, the SST, SWS and PS locations have been located between LA and Anaheim as described in Section 4.1.1. At this level of study, we do not have exact locations for the Traction Power Supply, Switching and Paralleling Stations (with regards to geographical constraints), or the possible connection points to the SCE HV network.

The feeding configuration that has been considered for the traction power simulation is shown below with the Traction Power Supply Stations (SST) located close to Anaheim and close to Los Angeles Union Station.



For the Traction Power Supply Simulations between Los Angeles Union Station and Anaheim, the following stationing has been used for the location of the traction power supply, switching and paralleling stations. Union Station is nominally considered to be MP 0.00:

- The Traction Power Supply Station (SST) is located close to Anaheim station at MP location 29.32
- The Paralleling Stations (PS) are located at Norwalk (MP 14.20), Fullerton (MP 20.46) and at LA (MP 0.93)
- The Switching Stations (SWS) are located just after Redondo Junction, at MP 5.90 on the Anaheim line and at MP 4.35 on the San Diego line.

Between Sylmar and Los Angeles, the locations of the Traction Power Supply, Switching and Paralleling Stations are as follows:

- The Traction Power Supply Station (SST) is located close to just north of Los Angeles Union Station at MP 4.0
- The Paralleling Stations (PS) are located before and after Burbank, respectively at MP 9.0 (named PP1) and MP 14.0 (named PP2).
- The Switching Station (SWS) is located south of Sylmar, at MP 19.0.

It is to be noted on the LOSSAN corridor, between LA Union Station and Anaheim, that:

- The location of the Traction Power Supply Station is close to a 225 kV SCE line and to a main SCE HV substation. The maximum distance to feed the Traction Power Supply Station from the SCE HV substation would be between 2 and 4 miles.
- If the extension of the line to Irvine is decided, there will be only about 15 additional miles to feed from the SST. This distance can be fed without significant voltage drop using two (2) more paralleling stations (with one at the far end of the line) in order to maintain a 2x25 kV System.
- In a 1st phase operation from LA Union Station to Anaheim only, it would be possible to extend the feed from the Anaheim SST to LA Union station without any restrictive voltage drops, as it could be seen from the results of the simulation. For this initial operation phase the Phase Break at the SWS at MP 5.90 would be temporarily bridged.



Figure 6: Feeding configuration between Los Angeles and Anaheim used for the traction power simulation

4.1.4 Electrical Characteristics of the SST and PS Used for the Traction Power Simulation

The electrical characteristics of the SST and PS taken into account for the traction power simulation are:

- An internal impedance value of $0.028 + j \times 0.449 \Omega$ for the PS with autotransformer of 10 to 30 MVA.
- An internal impedance value of $0.0656 + j \times 1.8354 \Omega$ for the SST for power transformers of 60 to 120 MVA.
- An impedance of connecting cables of $0.001 + j \times 0.001 \Omega$.
- A no-load voltage of the SST Transformers of 27.5 kV.

4.1.5 Wire Characteristics Used for the Traction Power Simulation

The main characteristics of the overhead contact system conductors, negative feeder wire, running rails and other wires cables taken into account for the traction power simulation are listed below:

Designation	Information	Comments
Running rail	UIC 60	Ballast isolation 2.5 Ω .km Ground resistivity 100 Ω .km
Feeding wires	Contact wire Cu of 150 mm ² (flat part of 13.6 mm) Messenger cable Bz of 116 mm ² (diameter of 12.1 mm) Negative feeder ACSR of 288 mm ² (diameter of 20.5 mm)	A 10 % wear is taken into account
Other wires and cables	AEC of 93 mm ² ACSR (diameter of 12.5 mm) BEC 35 mm ² Cu	ACSR = Aluminum Core Steel Reinforced

The geometrical characteristics of the conductors of the Overhead Contact System and the Return System are as follows:

Wires	X (in m)	Y (in m)
BEC	-4	-1
Contact wire track 1	0	5.1
Contact wire track 2	4.52	5.1
Negative feeder track 1	-4	6.4
Negative feeder track 2	8.46	6.4
AEC track 1	-2.64	5.5
AEC track 2	7.16	5.5
rail 1 track 1	-0.7175	0
rail 1 track 2	3.725	0
rail 2 track 1	0.7175	0
rail 2 track 2	5.16	0
Messenger cable track 1	0	6.5
Messenger cable track 2	4.52	6.5

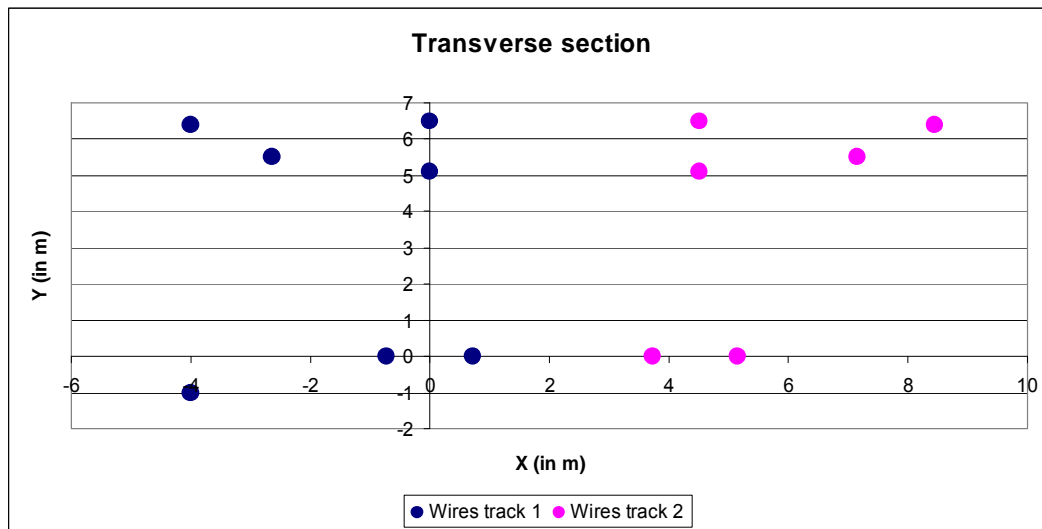

4.2 ROLLING STOCK HYPOTHESES

4.2.1 General Rolling Stock Information

The high-speed train set technology has not yet been identified for the CHSTP and may include, but not be limited to, the Siemens - ICE 3 (Velaro E), the Shinkansen – 700 Series, the Bombardier - AVE S-102 or the Alstom – AGV. For purposes of this analysis, a comparison was made as to the operational characteristics of these trainset technologies affecting traction power system performance.

- The main characteristics of the ICE 3 (Velaro E) latest German technology, for a twin-set, with regards to power simulation, are:
 - 16 MVA of traction power at full speed.
 - 400 m long for an 850 ton weight.
 - Maximum commercial speed of 350 kph.
 - 808 seats available.



- The main characteristics of the Shinkansen 700N latest Japanese technology, for the equivalent of a twin-set (only long single-set unit running), with regards to power simulation, are:
 - 17 MVA of traction power at full speed.
 - 430 m long for a 700 ton weight.
 - Maximum commercial speed of 300 kph currently.
 - 1323 seats available.



- The main characteristics of the Bombardier - AVE S-102 technology used in Spain, whose latest version is the double-deck Duplex, for a twin-set, with regards to power simulation, are:
 - 16 MVA of traction power at full speed
 - 400 m long.
 - Maximum commercial speed of 330 kph currently.
 - 630 seats available.

- The latest version of the French high-speed train technology is the AGV that will be able to run at a commercial speed of 360 kph and is under development.

As the data required to run the traction power simulation is not available for all of the above high-speed train set technologies that might be used for the CHSTP, conservative data at this early preliminary design stage was used to run the traction power simulation.

As such, the double-deck TGV “Duplex” has been used for the purpose of the traction power simulation. Its main characteristics, for a double trainset, are:

- 19 MVA of traction power at full speed (here in the simulation with single-set train, power raises only up to 8 MVA due to speed limitations)
- 400 m long for an 840 ton weight.
- Maximum commercial speed of 320 kph currently.
- 1030 seats available.



4.2.2 Rolling Stock Data Used for the Traction Power Simulation

The following rolling stock data for a “Duplex” TGV train as applied to the traction power simulation is as below:

Designation	Information	Comments
Train set	Single train	
Length	400 m	Total
Tare weight and payload	838 t	
Mass factor	1.04	
Nominal voltage	25 kV	
Mean voltage	22.5 kV	This voltage corresponds to the curve given hereafter
Highest speed	320 km/h	Of rolling stock
Tolerance of speed control	0 km/h	
regenerative braking	Without	
Maximum Acceleration	1.3	In m/s ²
Operating acceleration	1.1	in m/s ²
Operating deceleration	1.1	in m/s ² (constant)
Train resistance formula	A=540 B=6.4 C=0.0979	The formula in daN is: F = A+BxV+CxV ² with V in km/h.
Auxiliary power of traction unit	200 kVA	50 kVA per traction unit
Auxiliary power of coaches	630 kVA	A 0.35 coefficient is taken into this value
Tractive effort-speed characteristic curve	Cf. figure 7	Wheel tractive effort en daN in function of speed
Tractive power factor	Cos phi = 0.98	
Efficiency	90 %	

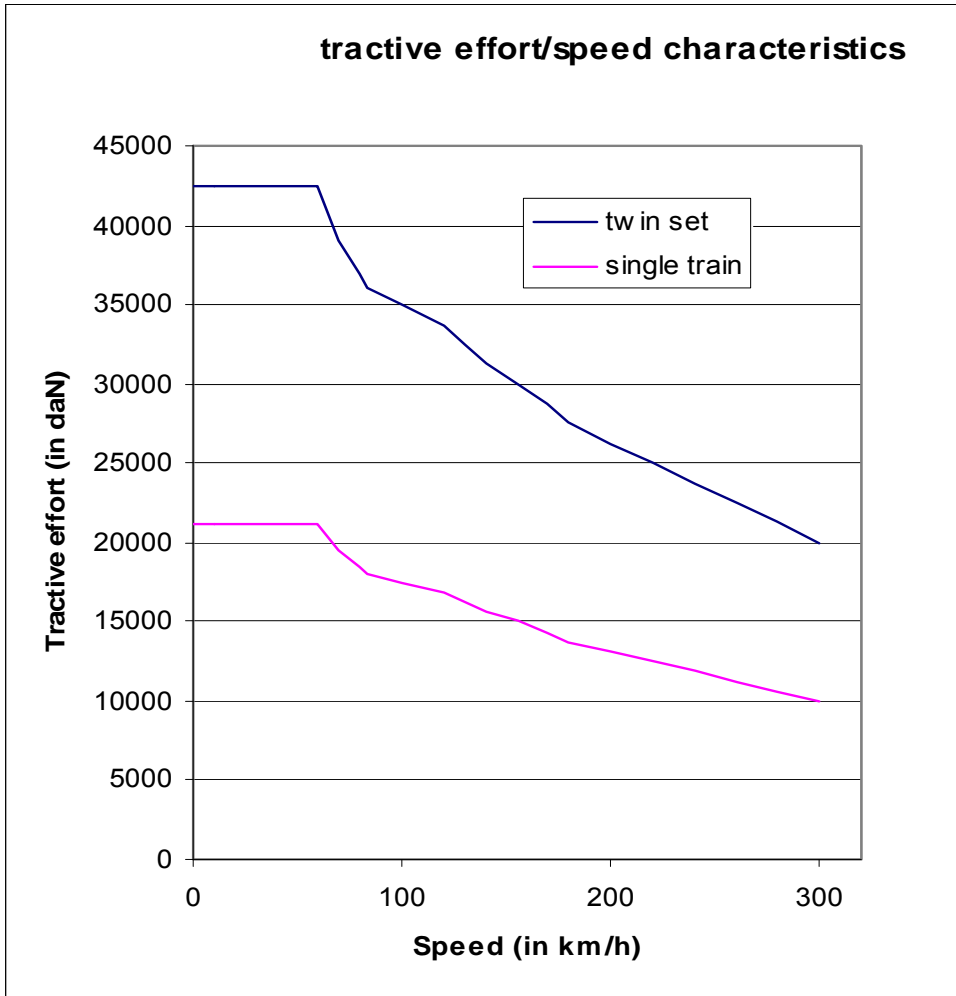

Figure 7

4.3 OPERATION ON SYLMAR - LA UNION STATION - ANAHEIM LINE

4.3.1 Speed Limitations

On the LA Union Station to Anaheim line, while the design speed is 125 mph, with a stop at Norwalk station, the maximum speed that can be reached because of the alignment is 110 mph. In addition there are speed limitations due to curves along the line that will limit the speed through the curves to 35 mph.

On the Sylmar to LA Union Station line, while the design speed is 250 mph, due to the alignment and the stop at Burbank station, the maximum speed that can be reached is around 160 mph.

4.3.2 Operating Plan Used for the Traction Power Simulation with 20 Trains per Hour

It is assumed that double train sets (400 m long) are running along the line. The timetable used for the simulation for 20 trains per hour and per direction between Sylmar and Redondo Junction via LA Union Station is below:

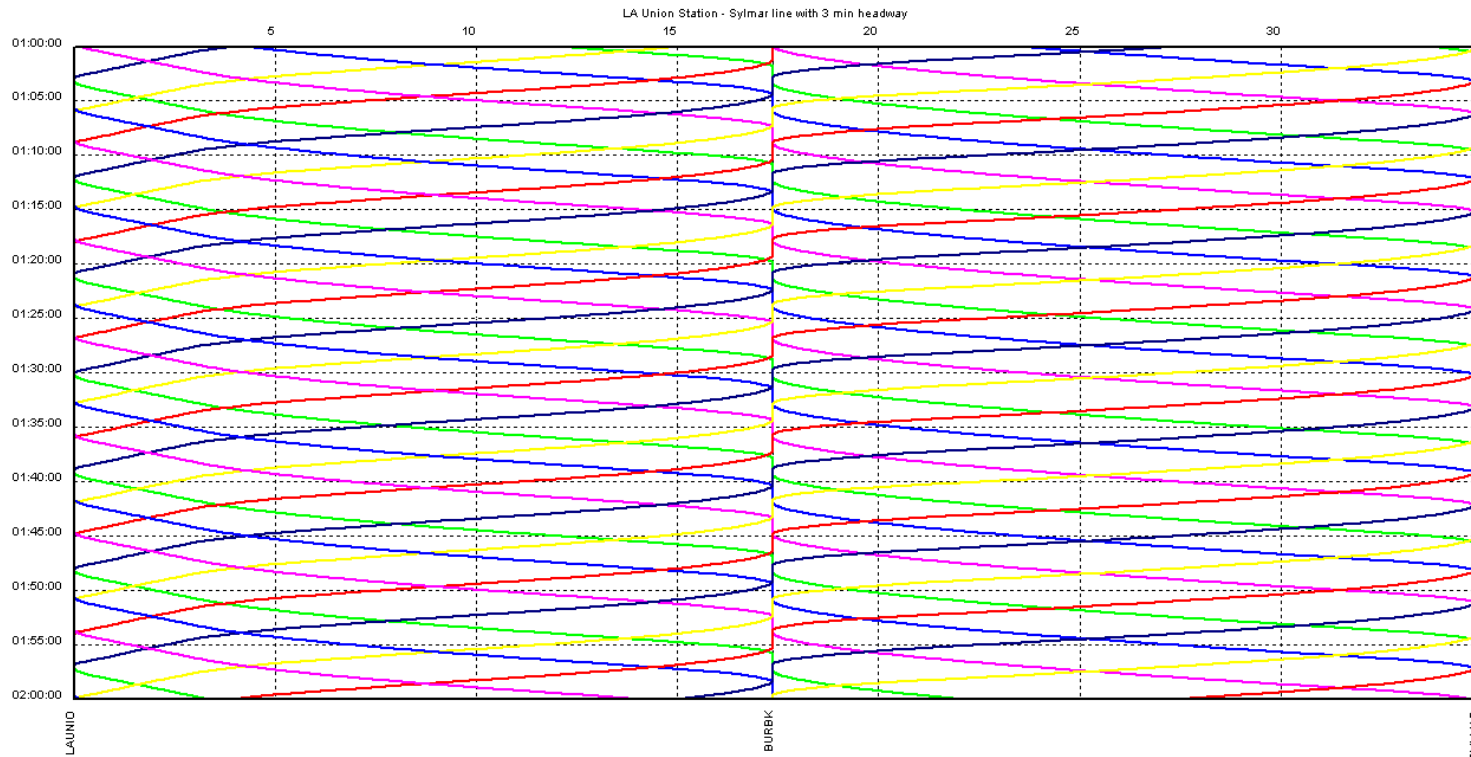

The timetable used for the simulation for 20 trains per hour and per direction between LA Union and Redondo Junction with 6 trains per hour and per direction between Redondo Junction and Anaheim is below:

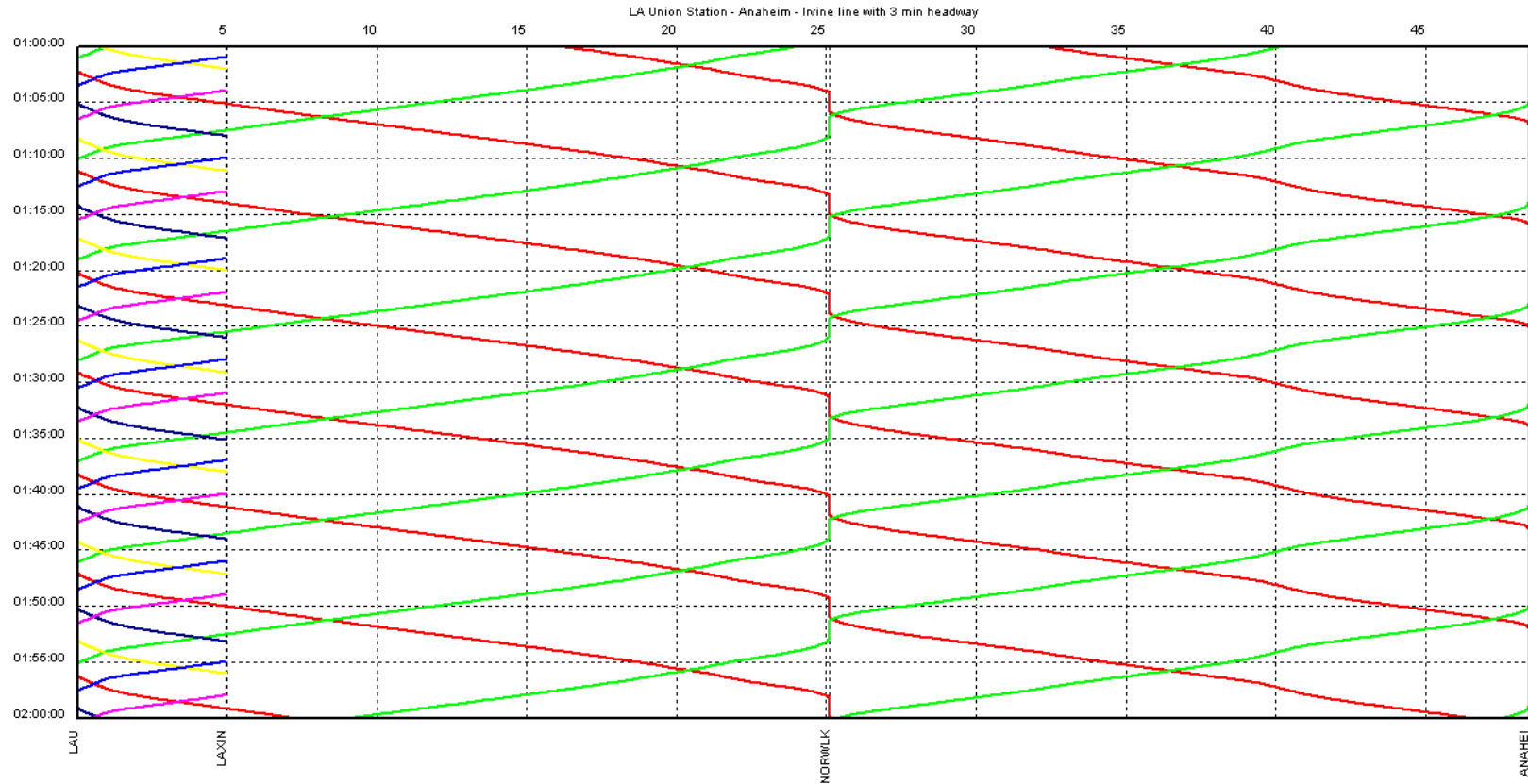

4.3.3 Operating Plan Used for the Traction Power Simulation with 16 Trains per Hour

It is assumed that double train sets (400 m long) are running along the line. The timetable used for the simulation for 16 trains per hour and per direction between Sylmar and Redondo Junction via LA Union Station is below:

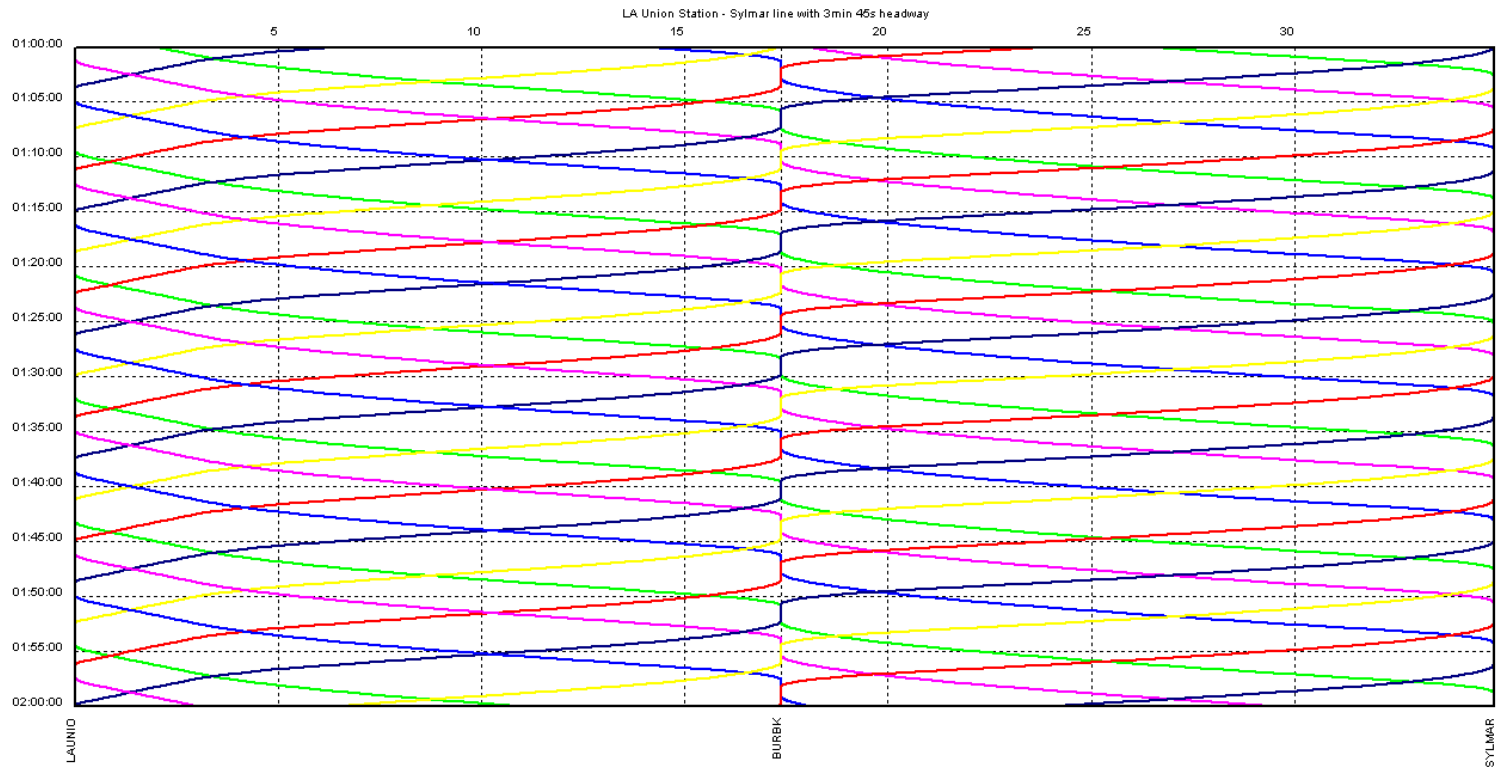

The timetable used for the simulation for 16 trains per hour and per direction between LA Union and Redondo Junction with 6 trains per hour and per direction between Redondo Junction and Anaheim is below:

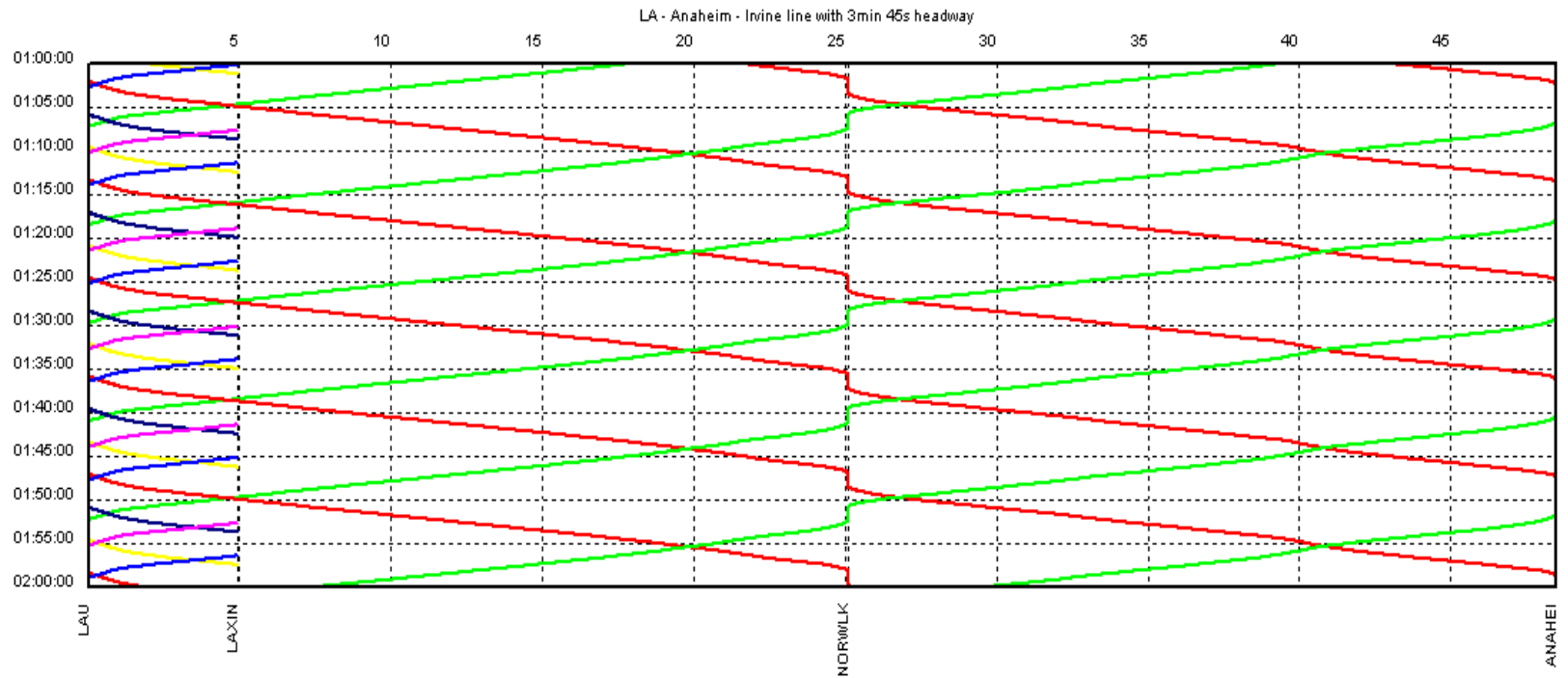

5.0 TRACTION POWER SIMULATION – RESULTS, ANALYSIS AND CONCLUSIONS

The main criteria for the verification of acceptable locations for the Traction Power Supply, Switching and Paralleling Stations is:

- The line voltage (at the connecting point with pantograph) has to be within the bounds of the IEC 60 850 standard, that means a minimum line voltage of 19 kV in a permanent mode and 17.5 kV for a maximum of 2 minutes.
- The power needed at Traction Power Supply, Switching and Paralleling Stations should not exceed the installed power capacity. Furthermore, traction power supply equipment shall be able to support an overload of 50% for 15 minutes and 100% for 5 minutes.

The results of the simulation are included in the attached appendices (Figures 8 through 24), and lead to the following analysis and conclusions.

For the full length of the Segment from Sylmar to Anaheim:

- The minimum line voltage is always above 22.8 kV (>19kV minimum requirement in permanent mode) and is therefore satisfactory.(Figs. 9, 10, 17 & 18)

For the Anaheim to Redondo Junction Section:

- The maximum load at the Anaheim SST is satisfactory. The 60 MVA power rating for each of the 2 transformers of the SST is high enough because for the simulations for the timetables of both the 16 and 20 trains per hour per direction, the rms apparent power is approximately 25 and 30 MVA respectively. The power rating of these transformers should be sufficient to feed the line if there is an extension to Irvine (but this has to be confirmed through a new electrical simulation). (Figs. 11 & 19)
- The location of the SST close to Anaheim station is efficient as far as supporting the required OCS voltage; i.e. the catenary voltage is always above 24 kV, even up to LA Union station as it would be in the 1st phase. Furthermore, as the SST is located at the far end of the LA-Anaheim line, it would be able to feed the line up to Irvine, if the extension is required.
- The maximum power at the PS and SWS between LA Union Station and Anaheim is satisfactory. One autotransformer rated 10 MVA for each PS, and two autotransformers rated at 10MVA each at the SWS are sufficient for the Anaheim line. (Figs.13 & 21). However, the load on the autotransformers at the Fullerton and Norwalk PS with 7 trains per hour per direction is close to the full load rating. (Fig. 13).
- The maximum current in the conductors is satisfactory and would not cause overheating of the conductors. (Figs. 15 & 23)
- The selected preliminary locations of the SST, SWS and PS's have therefore been verified as feasible for the planned operation of six high-speed trains per hour and per direction between Redondo Junction and Anaheim.

For the Redondo Junction to Sylmar Section:

- The 60 MVA transformers in the Union Station SST are considerably overloaded for both 20 and 16 trains per hour per direction. As the Traction Power Supply Stations (SST) shall be designed with 2 power transformers with each capable of supplying the full load of the SST, (for redundancy purpose). The maximum power rating of the Transformers at

the SST near Union Station would need to be increased to 120 or 100 MVA, respectively for the timetables of 20 and 16 trains per hour per direction.,(Figs. 12, & 20)

- The maximum power load of the two PS and the SWS between LA Union and Sylmar for the timetables of 16 and 20 trains per hour per direction is well above the provisional 10 MVA rating, being 26MVA, 21MVA and 14MVA respectively for 20 trains per hour per direction, and 21MVA, 16MVA and 12MVA respectively for 16 trains per hour per direction. (Figs 14 & 22)
- The maximum current in the conductors is satisfactory and would not cause overheating of the conductors (Figs. 16 & 24)

General Comment:

Although the reduction in the number of trains per hour (from 20 to 16) has an obvious affect on the 10 minute rms power demand on the Los Angeles Traction Power Supply Station – a reduction from approximately 110MVA to 85MVA, it has a lesser effect on the OCS voltage and current in the OCS/NF conductors.

The main reason for this is that the reduction in the number of trains per hour, or the increase in headway, is not sufficient to change the number of trains operating in the individual “Electrical” Sections therefore the currents in the various conductors are not changed by the reduction in the number of trains operating on the System.

There is some effect on the Lossan Corridor Section since in order to blend in the Lossan trains with the 10 trains on the San Diego/Los Angeles route there is a reduction of 1 train per hour (from 7 to 6) on the Lossan corridor.

General conclusion and recommendation for further simulations

From the Simulation results of the Sylmar to Redondo Junction Section it can be seen that although the preliminary locations of the Traction Power Supply, Switching and Paralleling Stations supports the required OCS voltage the Transformers and Autotransformer in the stations are considerably overloaded with the operation of both 20 or 16 double consist trains per hour per direction.

Consequently, it will be necessary to perform further simulations to:

1. Verify the maximum number of double train consists that can be operated per hour per direction with the present preliminary traction power supply configuration and transformer/autotransformer ratings.

And if the number of double train sets that can be operated does not meet the projected operation requirements:

2. Verify what reasonable mix of single and double train sets the present traction power supply configuration can support.
3. Determine what changes must be made to the present traction power supply configuration and/or transformer ratings to support the operation of the projected number of double train sets per hour per direction.

APPENDIX 1: EXAMPLE OF TRAIN SPEEDS

Figure 8 Example of train speeds

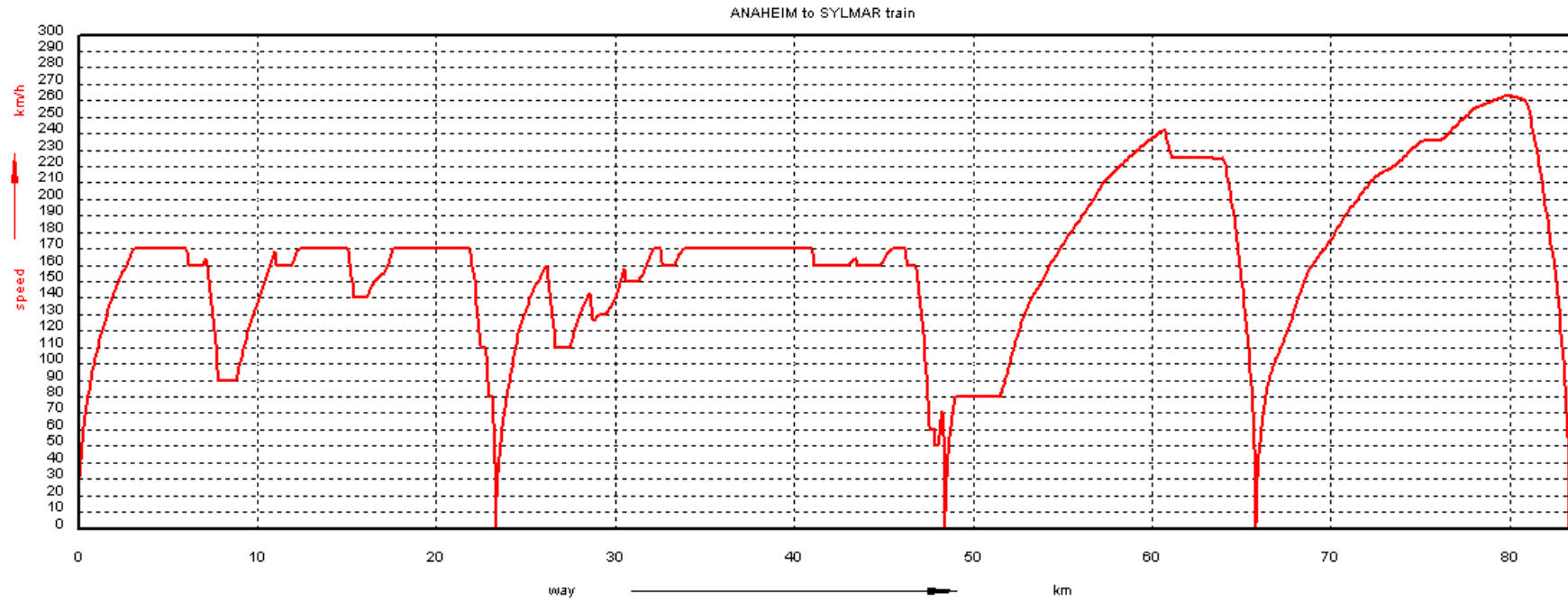

APPENDIX 2: SIMULATION RESULTS FOR 20 TRAINS PER HOUR

Electrical results

Figures 9 and 10 Min. voltages for tracks 1 and 2

These curves correspond to the minimal voltage value for each train at a peculiar chainage.

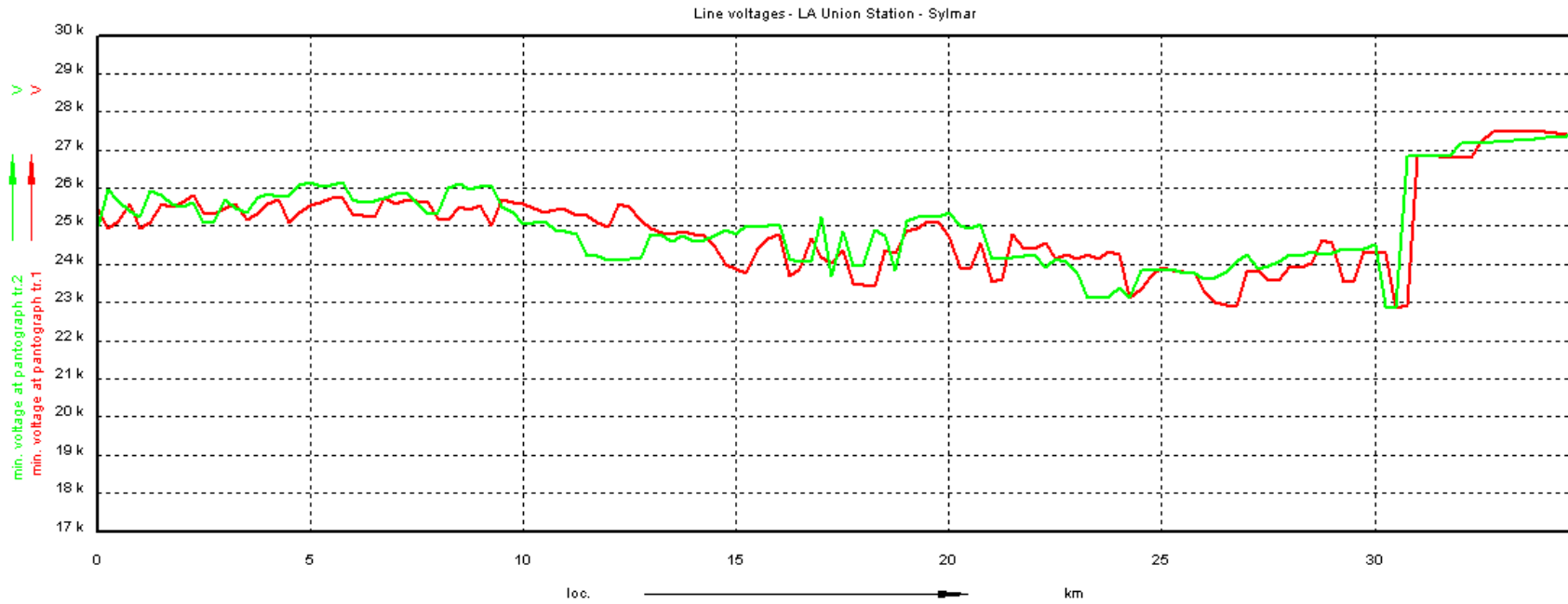

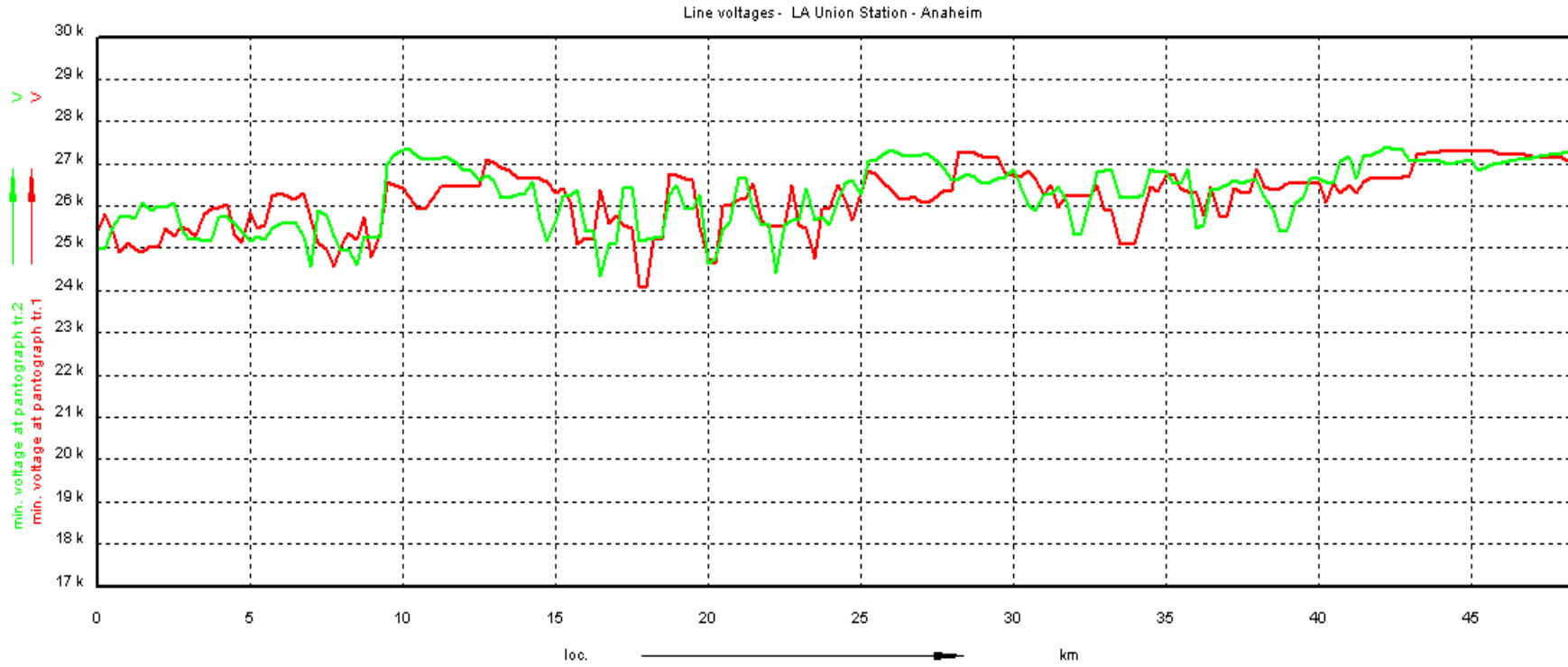

Figure 11 Apparent power of SST Anaheim

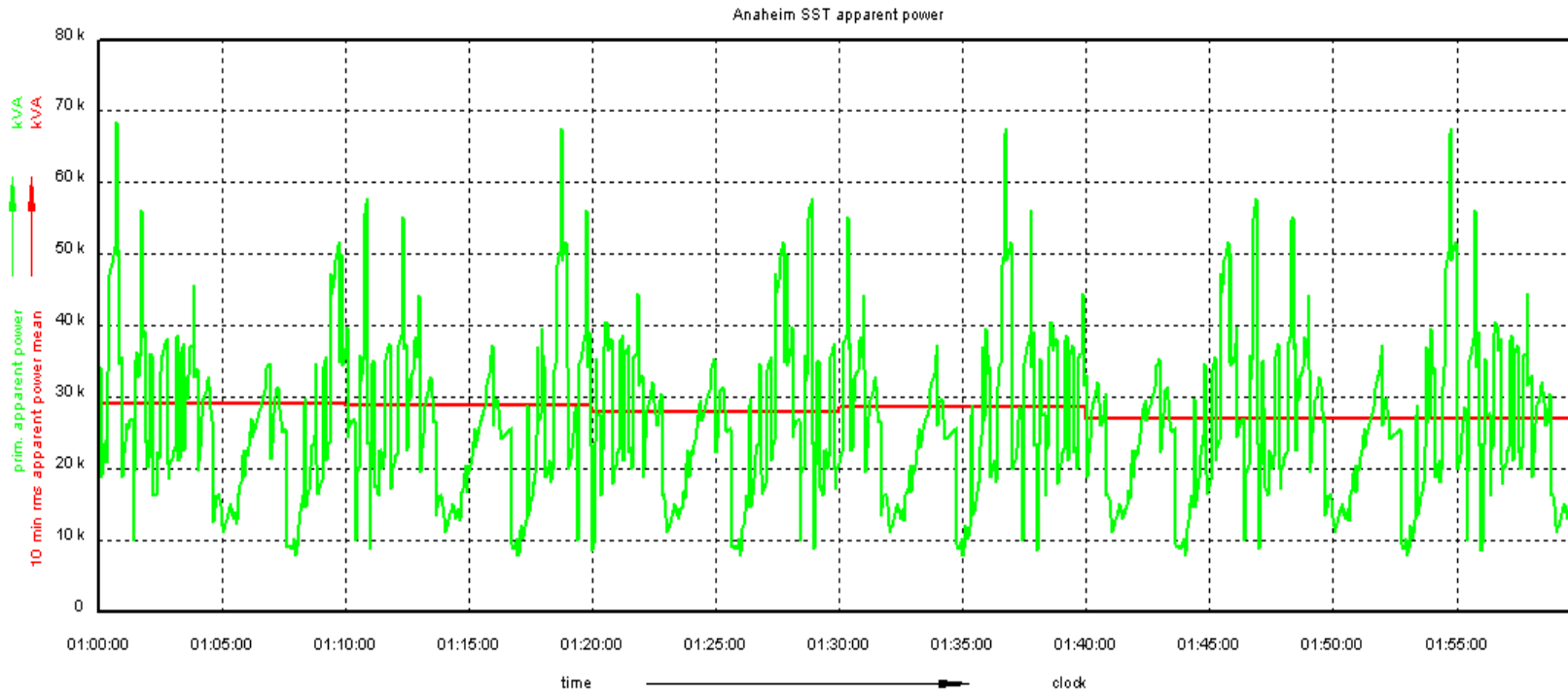
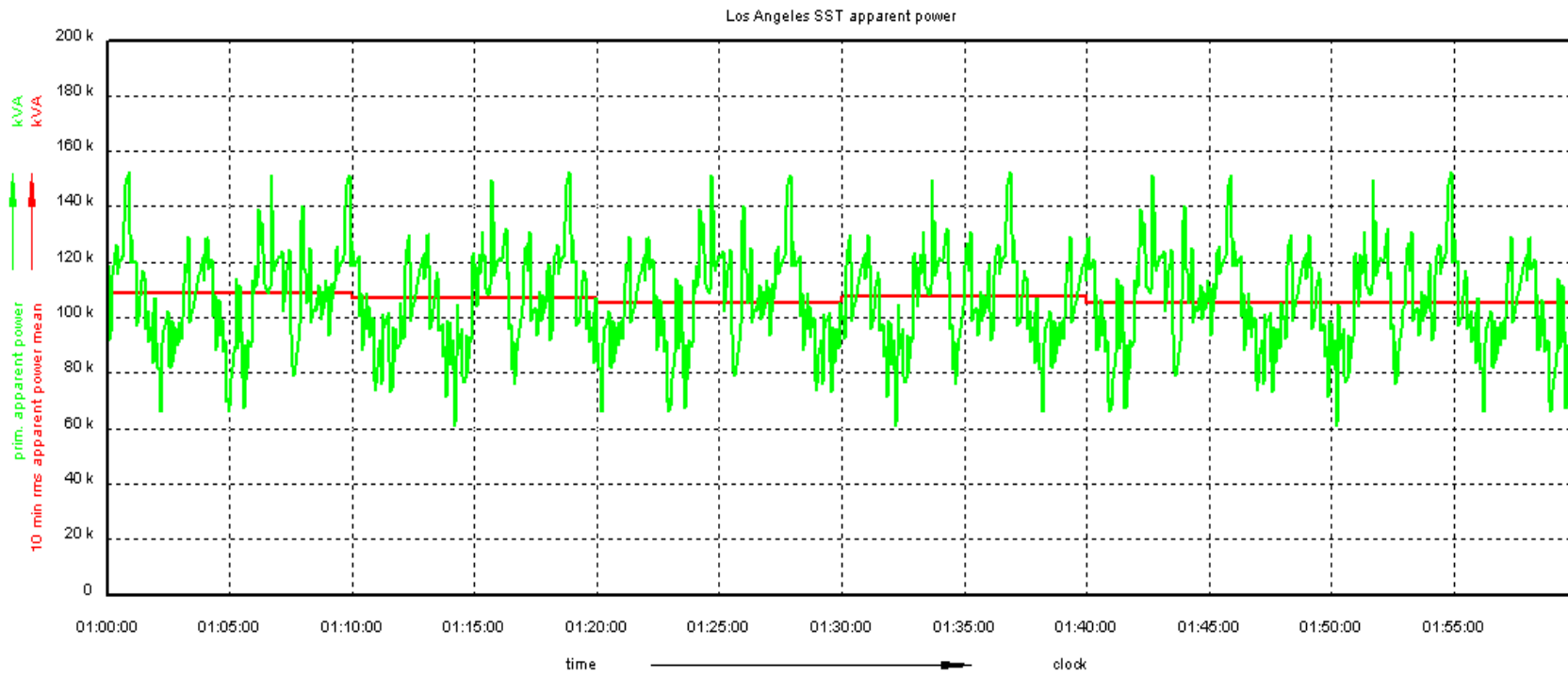
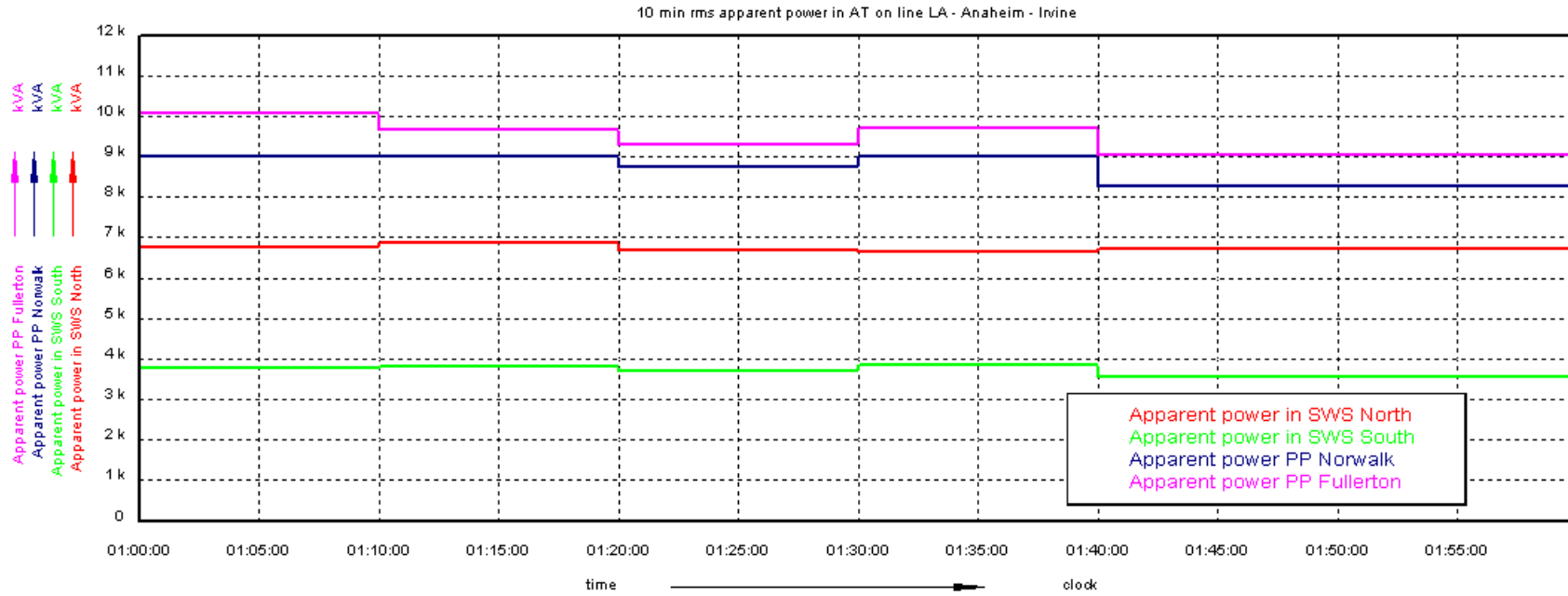
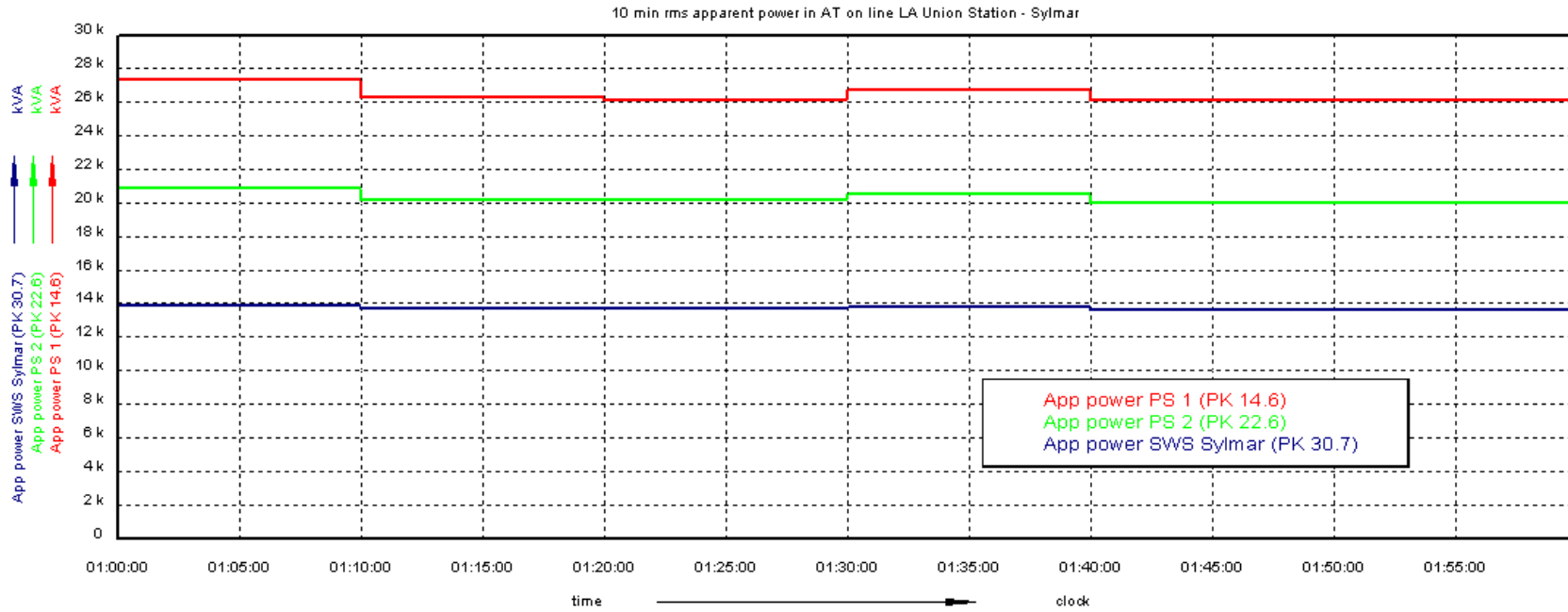

Figure 12 Apparent power of SST Los Angeles



Figures 13 and 14 10 minutes quadratic mean of apparent power of AT





Figures 15 and 16 Currents in the conductors

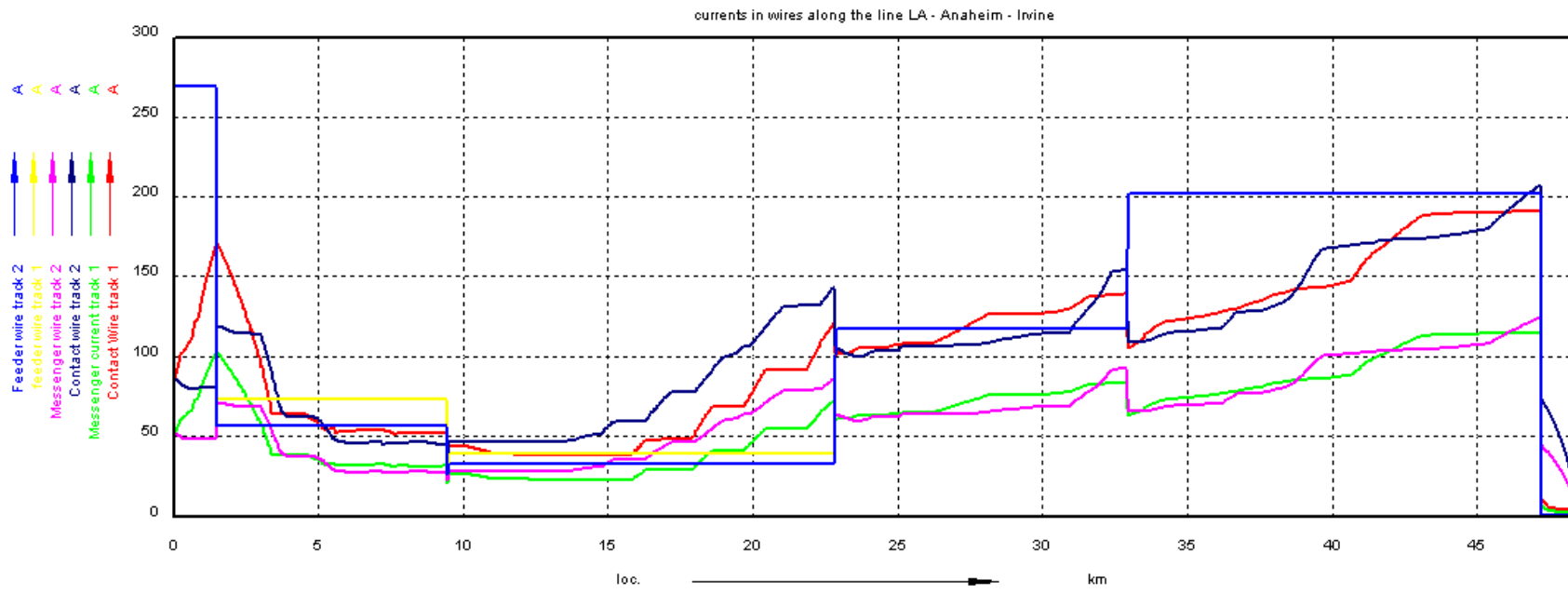

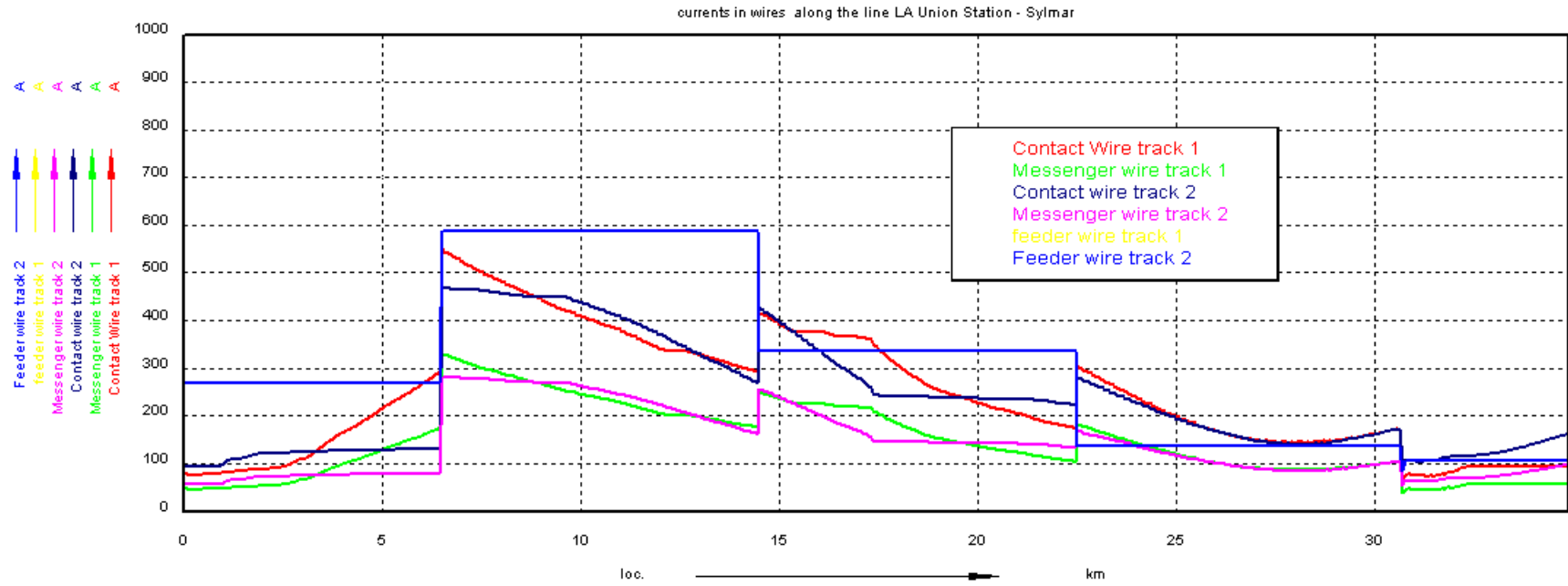

APPENDIX 3: SIMULATION RESULTS FOR 16 TRAINS PER HOUR

Electrical results

Figures 17 and 18 Min. voltages for tracks 1 and 2

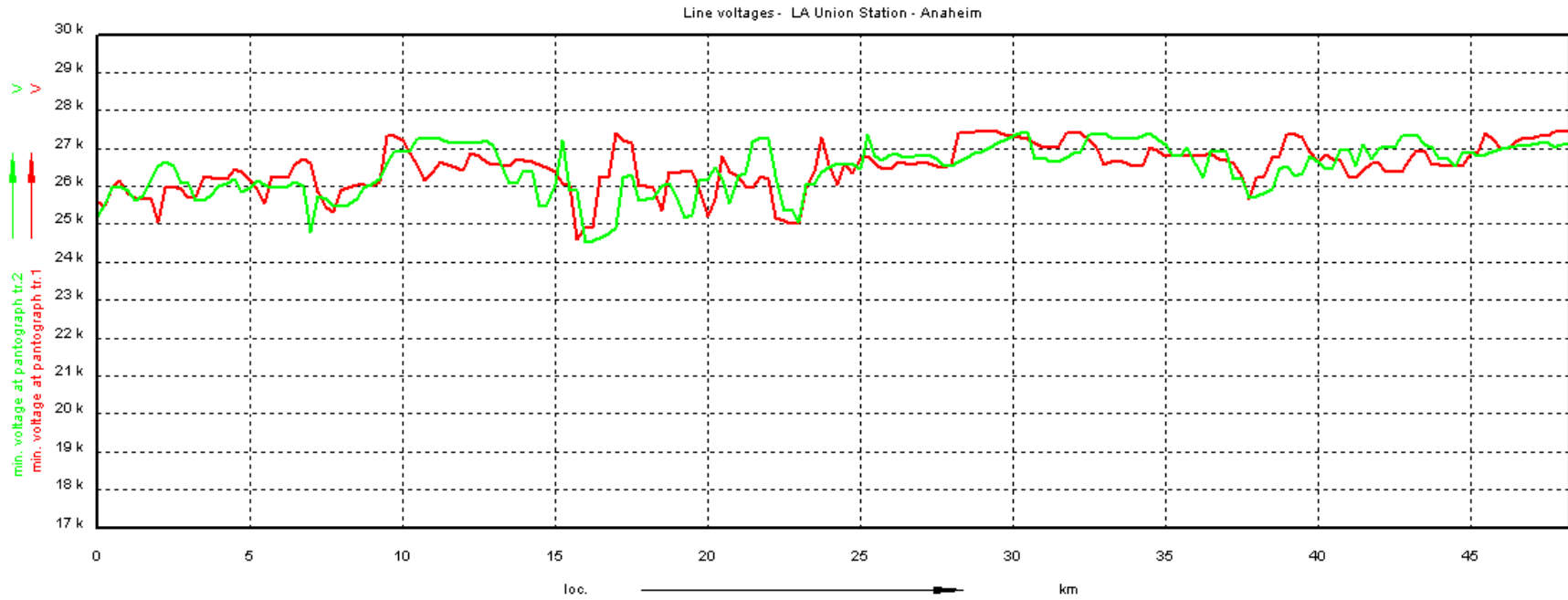

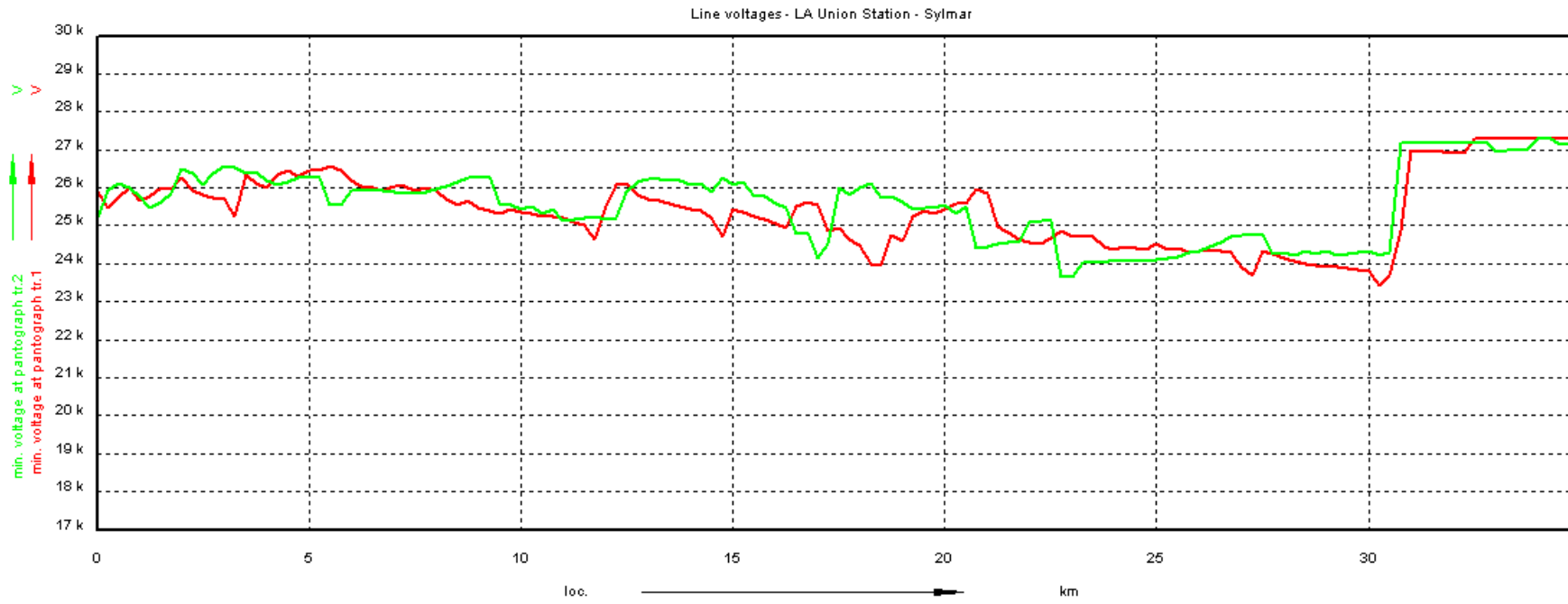

Figure 19 Apparent power of SST Anaheim

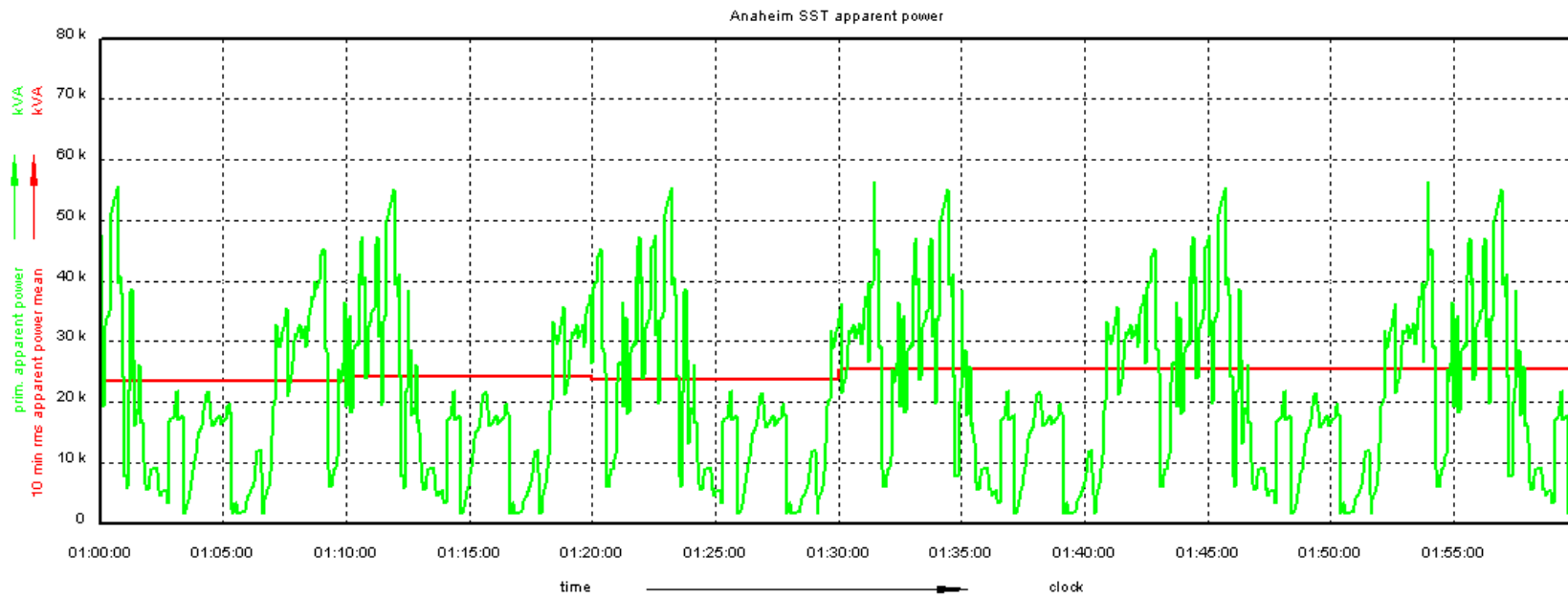
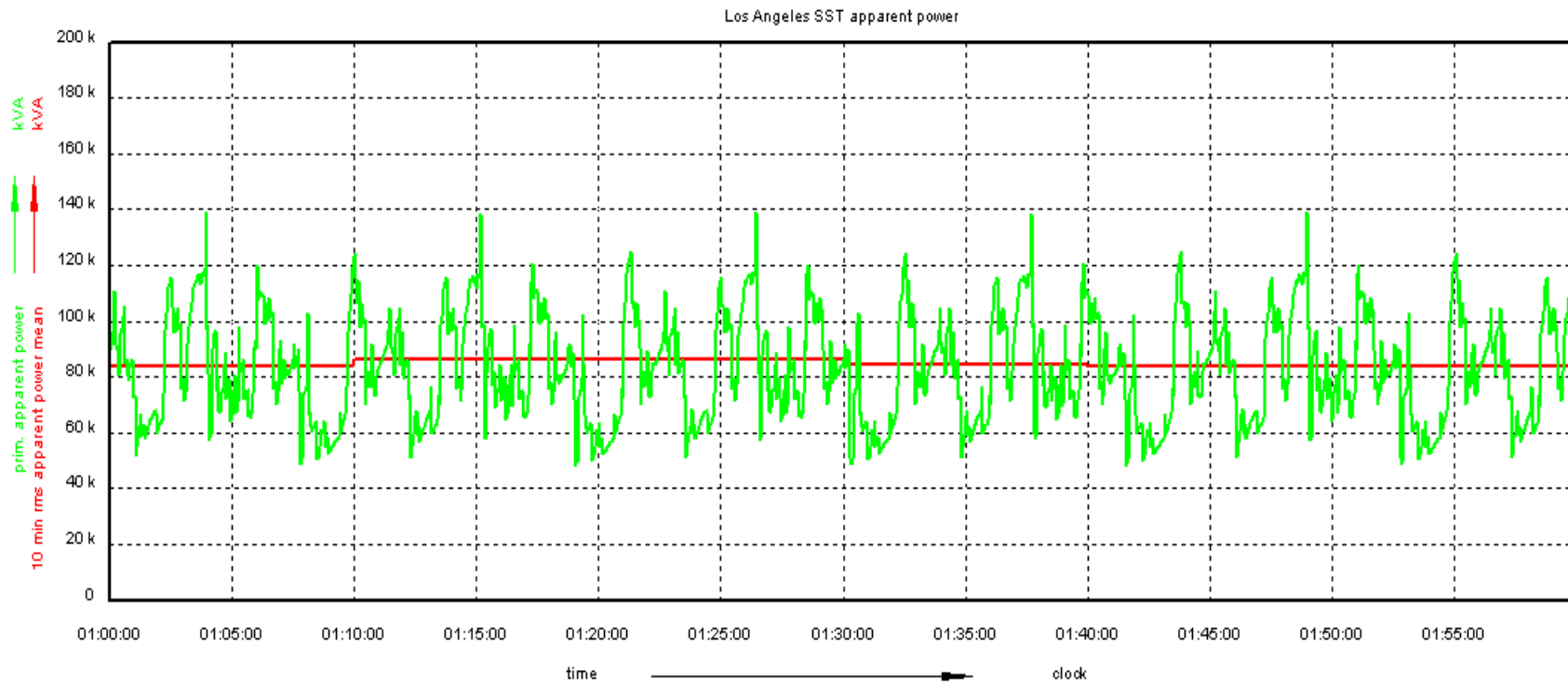
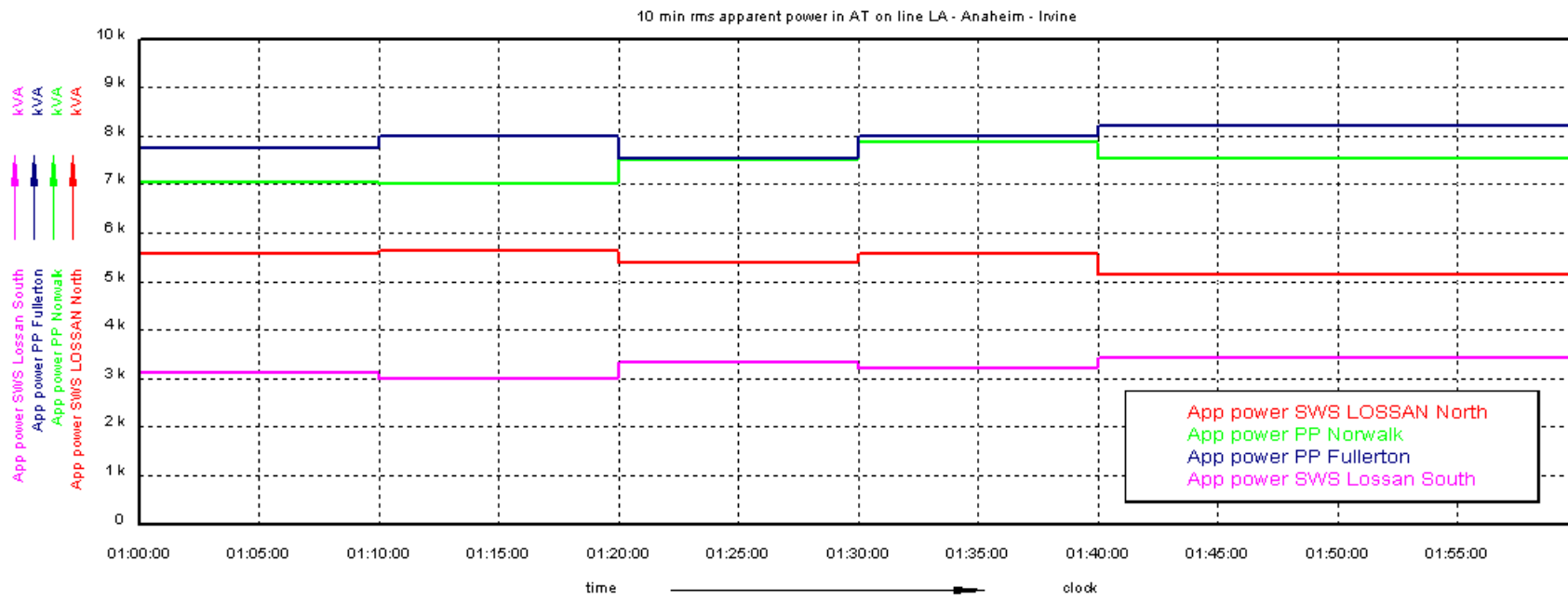
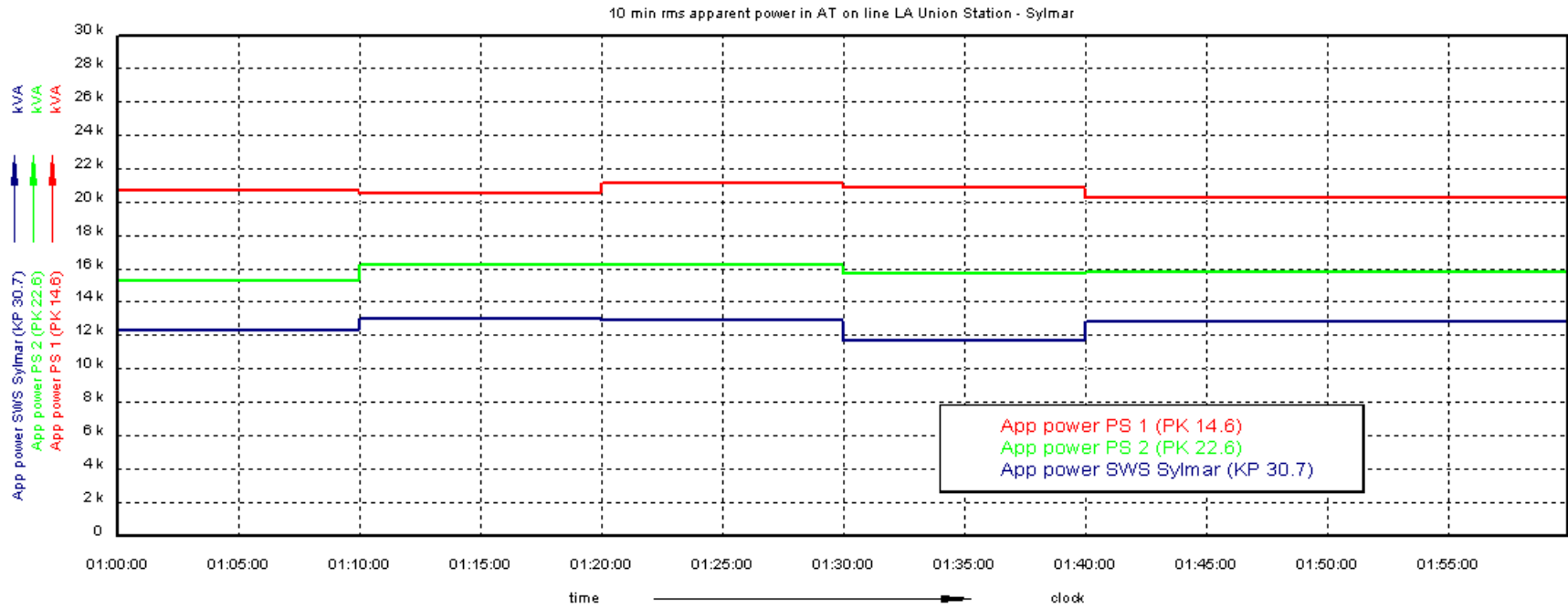

Figure 20 Apparent power of SST Los Angeles



Figures 21 and 22 10 minutes quadratic mean of apparent power of AT





Figures 23 and 24 Currents in the conductors

