

2.0 Alternatives

This chapter describes the background and development of the HST system and its individual components. This chapter also describes the background, development, and provides a detailed description of the alternatives considered for the Merced to Fresno Section of the HST System. Two alternatives discussed in this chapter are based on the alternatives selected by the Authority and FRA at the conclusion of the Tier 1 EIR/EIS processes (see Section 1.5, Tiering off Program EIR/EIS Documents. An additional alternative was developed based on public input during the scoping process. The design drawings that support the alternatives description are included as Volume III (Alignments and Other Plans) of the EIR/EIS. This Project EIR/EIS analyzes the environmental impacts for the Merced to Fresno Section of the HST System, including alternatives, direct and indirect impacts, cumulative impacts, secondary effects, and mitigation measures. Visit the California High-Speed Rail Authority web site (www.cahighspeedrail.ca.gov) to view and download the EIR/EIS, request a CD-ROM EIR/EIS, and locate a library to review a hardcopy of the environmental document. Printed copies of the EIR/EIS have been placed in public libraries in the following cities and communities: Sacramento, Atwater, Merced, Le Grand, Chowchilla, Fairmead, Madera, Fresno, and Los Banos. At the Authority's website, the following documents are also available: alternatives analyses preceding preparation of the Project EIR/EIS, materials prepared for coordination with the USACE and EPA in compliance with the Clean Water Act Section 404(b)(1) requirements, and technical reports developed for the environmental analyses presented in Chapter 3.

Definition of High-Speed Train (HST) System

A system that includes HST tracks, structures, stations, traction power substations, maintenance facilities, and trains able to travel 220 mph.

2.1 Background

2.1.1 California HST Project Background

The planning, design, construction, and operation of the California HST System are the responsibility of the Authority, a state governing board formed in 1996. The Authority's statutory mandate is to develop a high-speed rail system that is coordinated with the state's existing transportation network, which includes intercity rail and bus lines, regional commuter rail lines, urban rail and bus transit lines, highways, and airports. The Authority's plans call for high-speed intercity train service on more than 800 miles of tracks throughout California, connecting the major population centers of Sacramento, the San Francisco Bay Area, the Central Valley, Los Angeles, the Inland Empire, Orange County, and San Diego (Figure 2-1).

The California HST system is planned to be implemented in two phases. Phase 1 would connect San Francisco to Los Angeles and Anaheim via the Pacheco Pass and the Central Valley.¹ Phase 2 would connect from the Central Valley (from the Downtown Merced at-grade station, due north at-grade, on retained fill, or on elevated guideways) to the state's capitol, Sacramento, and another extension is planned from Los Angeles to San Diego (Figure 2-1). The HST System would meet the requirements of Proposition 1A, including the requirement for a maximum nonstop service travel time between San Francisco and Los Angeles of 2 hours and 40 minutes.

¹ Phase 1 may be constructed in smaller operational segments, depending on available funds.



Figure 2-1
 California HST System Initial Study Corridors

2.1.2 Merced to Fresno Section EIR/EIS Background

The Merced to Fresno HST Section would be a critical Phase 1 link connecting the Bay Area HST sections to the section south of Fresno to Los Angeles. The Authority and the FRA's prior program EIR/EIS documents (see Section 1.5, Tiered Environmental Analysis) resulted in selection of two different preferred alternatives for the Merced to Fresno Section. The Authority and the FRA selected the existing BNSF rail route as the preferred alternative for the Central Valley HST between Merced and Fresno in the Statewide Program EIR/EIS decision documents. However, in the subsequent Bay Area to Central Valley Program EIR/EIS (including revisions to the Bay Area to Central Valley EIR), the Authority and FRA selected the UPRR route as the preferred alternative for the Merced to Fresno Section and also mentioned that the BNSF would continue to be carried forward for further study. Therefore, the Merced to Fresno Section of the HST Project begins with corridors along both the UPRR and the BNSF for study in site-specific environmental analysis.

The Authority and FRA widely circulated the Draft EIR/EIS to affected local jurisdictions, state and federal agencies, tribes, community organizations, other interest groups, and interested individuals. The document was also available at Authority offices, public libraries, and community centers. The 60-day public comment period closed on October 13, 2011. During this period, public hearings were held to receive oral testimony on the project and Draft EIR/EIS. On December 13, 2011, the Authority Board selected the Hybrid Alternative, the Merced Station, and the Mariposa Station in Fresno as the preferred alternative and decided that decisions on the wye selection and HMF selection will be made during the environmental process for the San Jose to Merced Section. The selection of the wye depends on the east-west HST section between San Jose and Merced; while the effects of the wyes are analyzed to understand the total effects on the north-south alternatives, the ultimate selection depends on environmental analyses under study in the San Jose to Merced Section. The Draft EIR/EIS for the San Jose to Merced Section will be published in 2013. The Authority's and FRA's preferred alternative for the Merced to Fresno Section is discussed in Chapter 7, Preferred Alternative and Stations. This Final EIR/EIS addresses the comments received during the public comment period. Revised text is shaded. Chapter 8, Public and Agency Involvement, provides information on the public and agency comments received.

2.2 HST System Infrastructure

The following section provides general information about the components and function of the proposed the HST System. Detailed information on each alternative in the Merced to Fresno Section is provided in Section 2.3. The HST System is envisioned as a state-of-the-art, electrically powered, high-speed, steel-wheel-on-steel-rail technology, which would employ the latest technology safety, signaling, and automated train-control systems. The trains would be capable of operating at speeds of up to 220 mph over fully grade-separated, dedicated track.

The infrastructure and systems of the HST alternatives are composed of rolling stock, tracks, stations, train control, power systems, and maintenance facilities. The design of each HST alternative includes a

double-track rail system to accommodate planned project operational needs for uninterrupted rail movement. Additionally, the HST safety criteria preclude any at-grade intersections and, therefore, the system must be grade-separated from any other transportation system. This means that planning the HST System would also require grade-separated overcrossings or undercrossings for roadways or roadway closures and modifications to existing systems that do not span planned right-of-way. In some situations, it would be more efficient for the HST Project to be elevated over existing facilities.

2.2.1 System Design Performance, Safety, and Security

The proposed California HST System has been designed for optimal performance and to conform to all federal and state safety regulations (Table 2-1). The HST System would be a fully grade-separated and access-controlled guideway with intrusion detection and monitoring systems where required. This means that the HST infrastructure (e.g., mainline tracks and maintenance and storage facilities) would be designed to prevent access by unauthorized vehicles, persons, animals, and objects. The capital cost



estimates, presented in Chapter 5 of this EIR/EIS, include allowances for appropriate barriers (fences and walls), state-of-the-art communication, access-control, and monitoring and detection systems. Not only would the guideway be designed to keep persons, animals, and obstructions off the tracks, the ends of the HST trainsets would include a crash response management (CRM) system to minimize the effects of a collision. All aspects of the HST System would conform to the latest federal requirements regarding transportation security. The HST trainsets (train cars) would be pressure sealed to maintain passenger comfort regardless of aerodynamic change, much like an airplane body does. Additional information regarding system safety and security is provided in Section 3.11 of this EIR/EIS.

Table 2-1
 HST Performance Criteria

Category	Criteria
System Design Criteria	Electric propulsion system Fully grade-separated guideway Fully access-controlled guideway with intrusion monitoring systems Track geometry to maintain passenger comfort criteria (smoothness of ride, lateral acceleration less than 0.1 g [i.e., acceleration due to gravity])
System Capabilities	Capable of traveling from San Francisco to Los Angeles in approximately 2 hours and 40 minutes. All-weather/all-season operation Capable of sustained vertical gradient of 2.5% without considerable degradation in performance Capable of operating parcel and special freight service as a secondary use Capable of safe, comfortable, and efficient operation at speeds over 200 mph Capable of maintaining operations at 3-minute headways Equipped with high-capacity and redundant communications systems capable of supporting fully automatic train control
System Capacity	Fully dual track mainline with off-line station stopping tracks Capable of accommodating a wide range of passenger demand (up to 20,000 passengers per hour per direction) Capable of accommodating normal maintenance activities without disruption to daily operations
Level of Service	Capable of accommodating a wide range of service types (express, semi-express/limited stop, and local)

HST operation would follow safety and security plans developed by the Authority in cooperation with FRA to include the following:

- **A System Safety Program Plan, including a Safety and Security Certification Program**, which would be developed during the final design and construction phases, to address safety, security, and emergency response as it relates to the day-to-day operation of the system.
- **A Threat and Vulnerability Assessment for Security and a Preliminary Hazard Analysis and Vehicle Hazard Analysis** for safety during the preliminary engineering phase to produce comprehensive design criteria for safety and security requirements mandated by local, state, or federal regulations and industry best practices.
- **A Fire Life Safety Program and a System Security Plan.** Under federal and state guidelines and criteria, the Fire Life Safety Plan would address the safety of passengers and employees as it relates to emergency response. The System Security Plan would address design features of the project

intended to maintain security at the stations, within the trackwork right-of-way, and on board trains. Compliance with these measures would maximize the safety and security of passengers and employees of the HST Project so that adverse safety and security impacts would be less than significant.

Design criteria would address FRA safety standards and requirements as well as the Petition for Rule of Particular Applicability (RPA) that addresses specifications for key design elements for the system. The FRA is currently developing safety requirements for HSTs for use in the United States. The FRA will require that the HST safety regulations be met prior to revenue service operations. The following section describes those system components pertinent to the Merced to Fresno Section.

2.2.2 Vehicles

Although the exact vehicle-type has not yet been selected, the environmental analyses considered the impacts associated with any of the HST vehicles produced around the world that meet the Authority's criteria. All of the world's HST systems in operation today use electric propulsion with power supplied by an overhead system. These include, among many others, the Train à Grande Vitesse (TGV) in France, the Shinkansen in Japan and Taiwan, and the InterCity Express (ICE) in Germany. See Figure 2-2 for examples of typical HSTs.



Figure 2-2
 Examples of Japanese Shinkansen High-Speed Trains

The Authority is considering an electric multiple unit (EMU) concept that would equip several train cars (including both end cars) with traction motors compared to a locomotive-hauled train (i.e., one engine in the front and one in the rear). Each train car would have an active suspension and each powered car would have an independent regenerative braking system (which returns power to the power system). The body would be made of lightweight but strong materials with an aerodynamic shape to minimize air resistance, much like a curved airplane body.

A typical train would be 9 to 11 feet wide, consisting of one or two trainsets, each approximately 660 feet long and consisting of eight cars. A train of two trainsets would seat up to 1,000 passengers and be approximately 1,320 feet long with 16 cars. The power would be distributed to each train car via the overhead contact system (a series of wires strung above the tracks) and through a pair of pantographs that reach like antennae above the train to maintain contact with the wires (see Figure 2-3). Each trainset would have a train control system that can be independently monitored with override control while also communicating with the



Figure 2-3
 Example of an At-grade Profile Showing Catenary Wire System and Vertical Arms of the Pantograph Power Pickups

system-wide Operations Control Center. Phase 1 HST service is expected to need up to 94 sets of trains in 2035, depending on the HST fares charged.

A computer-based automatic train control (ATC) system would control the trains. The ATC system would provide for the FRA-mandated positive train control safety requirements, including safe separation of trains, over-speed prevention, and work zone protection. This would use a radio-based communications network that would include a fiber optic backbone and communications towers approximately every 2 to 3 miles, depending on the terrain and selected radio frequency. The towers would be located in the fenced HST corridor in a fenced area of approximately 20 feet by 15 feet, including a 10-foot-by-8-foot communications shelter and a 6- to 8-foot-diameter, 100-foot-tall communications pole. These communications facilities could be co-located with the traction power substations.

Station Parking Facilities

Parking demand expectations are based on HST system ridership forecasts where parking availability is assumed to be unconstrained – meaning 100% of parking demand is assumed to be met. These projections provide a “high” starting point to inform discussions with cities where stations are proposed. While this EIR/EIS identifies locations for parking facilities needed to satisfy the maximum forecast demand, parking is anticipated to be developed over time in phases, while also prioritizing access to the HST system through other modes such as transit, which could lead to less parking being necessary. See HST System Ridership and Station Area Parking in Section 2.5.3 for additional information.

2.2.3 Stations

The design of the station area will provide intermodal connectivity, drop-off facilities, an entry plaza, a station house area for ticketing and support services, a station box where passengers wait and access the HST, and parking facilities. Station design has not progressed beyond the conceptual stage. Figure 2-4 shows examples of station components from existing systems overseas; Figures 2-5a and 2-5b show an image of a potential “functional” station along with a plan view of the various station components. The functional station is a basic design which could be more elaborate with cooperation from the local jurisdiction—the station has the potential to be an iconic building that would help define the downtown transit core. Preliminary station planning and design are based on dimensional data from Station Platform Geometric Design guidance (Authority 2008); and volumetric data from Station Program Design Guidelines (Authority 2009a). All stations will be designed in accordance with Americans with Disabilities Act (ADA) accessibility guidelines.

2.2.3.1 Station Platforms and Trackway (Station Box)

The station box would provide a sheltered area for the HST trackway and platforms for passenger waiting, and circulation elements (stairs, elevators, escalators). Of the four tracks passing through the station, the two express tracks (for trains that do not stop at the station) would be separated from those that stop at the station and platforms by continuous window walls serving as windscreens and noise buffers. To allow enough distance for safe deceleration of trains, a platform track would diverge from each mainline track, beginning 3,000 feet from the center of the 1,410-foot station platform. In order to provide enough distance for acceleration back to the main line, less distance is needed before rejoining the mainline, but an additional stub end refuge track would be provided to temporarily store trains in case of mechanical difficulty or for special scheduling purposes, and for daytime storage of maintenance-of-way work trains during periods when structure and track maintenance is being performed along the line around the station. The wider footprint for the four-track section thus would extend for a total distance of 6,000 feet.

2.2.3.2 Station Arrival/Departure Facility (Station House)

The station house would be adjacent to the primary entrance and plazas. The station house would be open to both patrons and visitors. Services within the station house may include initial ticketing and check-in, traveler’s aid and local information services, and concessions. Circulation linkages between the station house and the station platforms may include hallways, an access bridge to cross over railroad tracks, stairs, escalators, elevators, and/or moving sidewalks.



Figure 2-4
Examples of Existing Stations

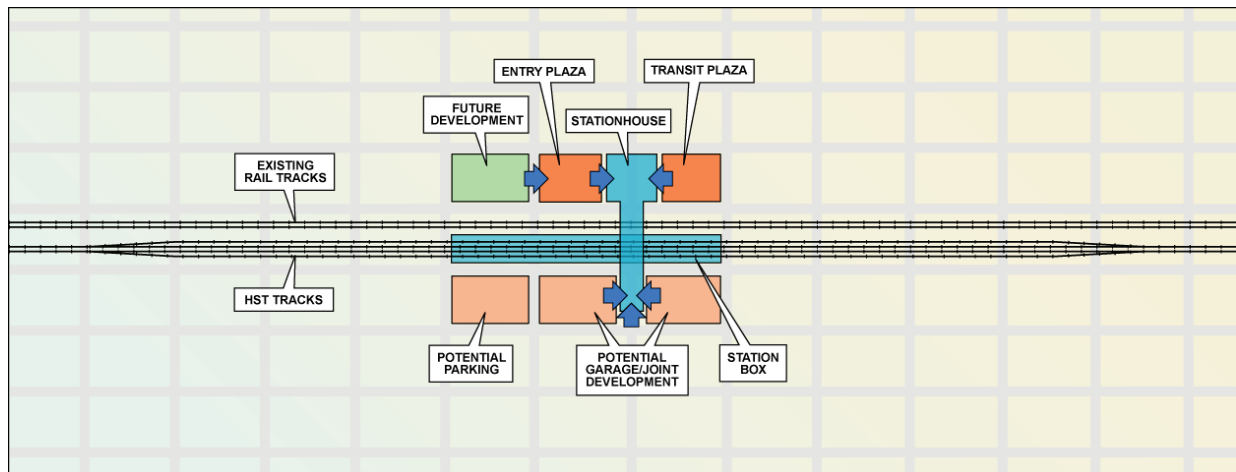

Figure 2-5a and b
Simulated and Plan Views of a Functional Station and
Its Various Components

2.2.4 Infrastructure Components

The dedicated, fully grade-separated right-of-way needed to operate high speed trains has more stringent alignment requirements than those needed for lower-speed trains. In the Merced to Fresno Section, the HST alternatives would use four different track profiles: low, near-the-ground tracks are at-grade; higher tracks are elevated or on retained earth; and below-grade tracks are in a retained cut. Types of bridges that might be built include full channel spans, large box culverts, or, for some larger river crossings, limited piers within the ordinary high-water channel. The various track profiles are described below.

2.2.4.1 At-Grade Profile

At-grade track profiles (Figure 2-6) are best suited in areas where the ground is relatively flat, as in the Central Valley, and in rural areas where interference with local roadways is less. The at-grade track would be built on compacted soil and ballast material (a thick bed of angular rock) to prevent subsidence or changes in the track surface from soil movement. For at-grade track, the top of the rail would be constructed at a minimum of 4.5 feet above the 100-year floodplain or higher when transitioning to an elevated structure. The height of the at-grade profile may vary to accommodate slight changes in topography, provide clearance for storm water culverts and structures in order to allow water flow, and sometimes wildlife movement.

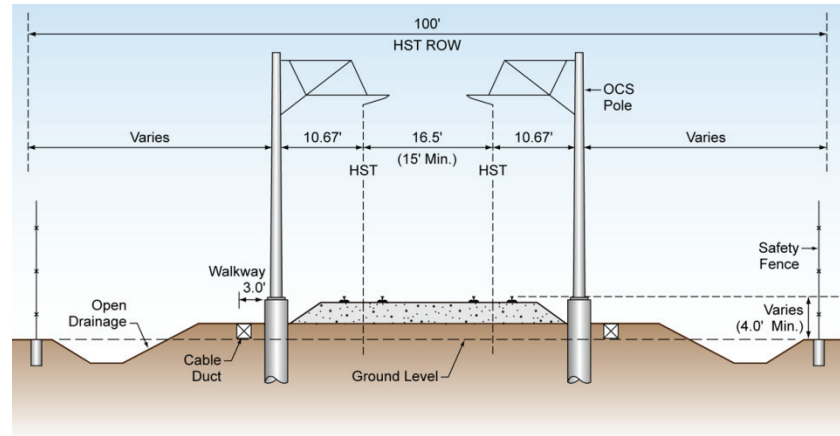

Figure 2-6
 At-grade Typical Cross Section

2.2.4.2 Retained-Fill Profile

Retained-fill profiles are used when it is necessary to narrow the right-of-way within a constrained corridor to minimize property acquisition or to transition between an at-grade and elevated profile. The guideway would be raised off the existing ground on a retained fill platform made of reinforced concrete walls, much like a freeway ramp (Figure 2-7a). Short retaining walls would provide the same effect and would protect the adjacent properties from a slope extending beyond the rail guideway. Retained-fill profile is typically used to transition between at-grade and elevated profiles and can be high enough to allow road undercrossings. Use of retained-fill would be evaluated on a case-by-case basis.

2.2.4.3 Retained-Cut Profile

Retained-cut profiles (Figure 2-7b) are used when the rail alignment crosses under existing roads or highways that are at-grade. This profile type is only used for short distances in highly urbanized and constrained situations. In some cases, it is less disruptive to the existing traffic network to depress the rail profile under these crossing roadways. Retaining walls would typically be needed to protect the adjacent properties from a cut slope extending beyond the rail guideway. Retained cut profiles are also used for roads or highways when it is more desirable to depress the roadway underneath an at-grade HST alignment.

2.2.4.4 Elevated Profile

Elevated profiles (Figure 2-8) can be used in urban areas where extensive road networks must be maintained. An elevated profile must have a minimum clearance of approximately 16.5 feet over roadways and 23.5 feet over railroads. Pier supports are typically approximately 10 feet in diameter at the ground. Such structures could also be used to cross water bodies; even though the trackway might be at-grade on either side, the width of the water channel could require a bridge at the same level, which would be built in the same way as the elevated profile.

Straddle Bents

When the HST elevated profile crosses over a roadway or a railway on a very sharp skew (degree of difference from the perpendicular), a straddle bent ensures that the piers are outside of the roadway or railway right-of-way.

As shown in Figure 2-9, a straddle bent is a pier structure that spans (or "straddles") the functional/operational right-of-way limit of a roadway, highway, or railway. Typical roadway and highway crossings that have a smaller skew angle (i.e., the crossing is nearly perpendicular) generally use intermediate piers in medians and span the functional right-of-way. However, for large-skew-angle crossing conditions, median piers would result in excessively long spans that are not feasible. Straddle bents that clear the right-of-way can be spaced as needed (typically 110 feet apart) to provide feasible span lengths for bridge crossings at large-skew angles.

2.2.5 Grade Separations

A safely operating HST system consists of a fully grade-separated and access-controlled guideway. Unlike existing track for passenger and freight trains in the Project area, there would be no at-grade road crossings, nor would the HST System share its rails with freight trains. The following describes possible scenarios for HST grade separations:

- **Roadway overcrossings** – There are many roadway and state route facilities that currently cross at-grade with or over the UPRR or BNSF railroad tracks. Figure 2-10a illustrates how a roadway would be grade-

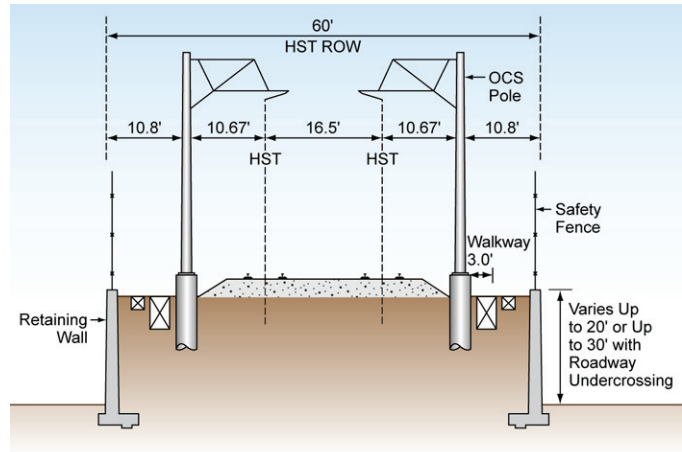

Figure 2-7a
 Retained Fill Typical Cross Section

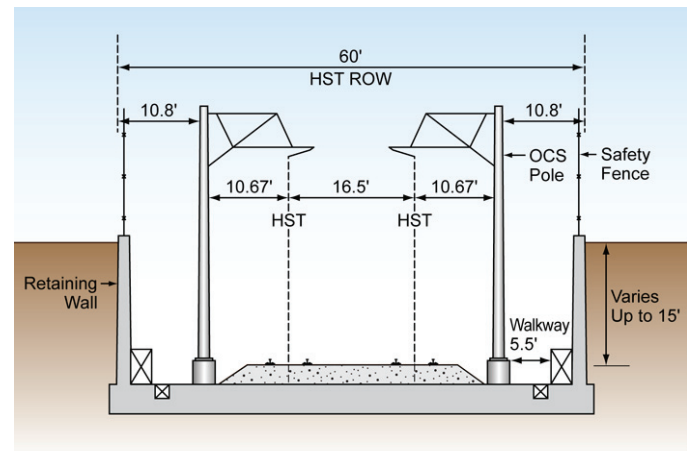

Figure 2-7b
 Retained Cut Typical Cross Section

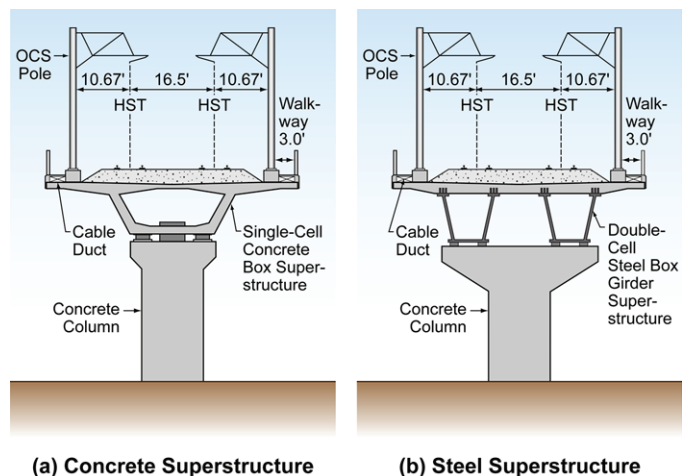

Figure 2-8
 Elevated Structure Typical Cross Sections

separated over both the HST and the railroad under these situations.

- **Local road overcrossings** – Similar conditions occur when an at-grade HST alignment crosses rural roads adjacent to farmland. Figure 2-10b is an example of a typical roadway overcrossing of the HST tracks; these overcrossings would generally occur approximately every 2 miles to provide continued mobility for local residents and farm operations.
- **Elevated HST road crossings** – In urban areas, it may be more feasible to raise the HST as shown in previously in Figures 2-8 and 2-9. This is especially relevant in downtown urban areas where use of an elevated HST guideway would minimize impacts on the existing roadway system.
- **Roadway undercrossings** – Each HST alternative would require an undercrossing for both northbound and southbound directions of the HST guideway to travel over SR 145 in Madera. Figure 2-11 illustrates how a roadway would be grade-separated below the HST guideway.

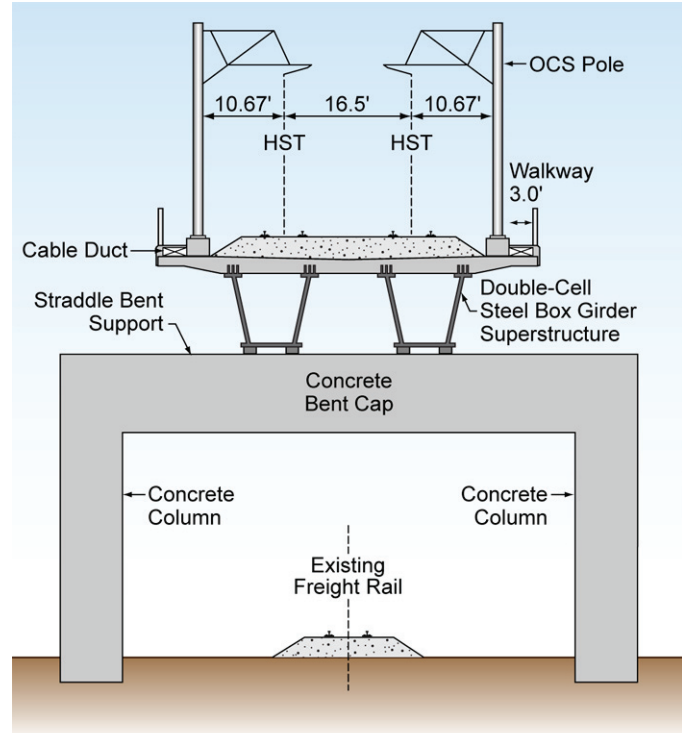

Figure 2-9
 Straddle Bent Typical Cross Section

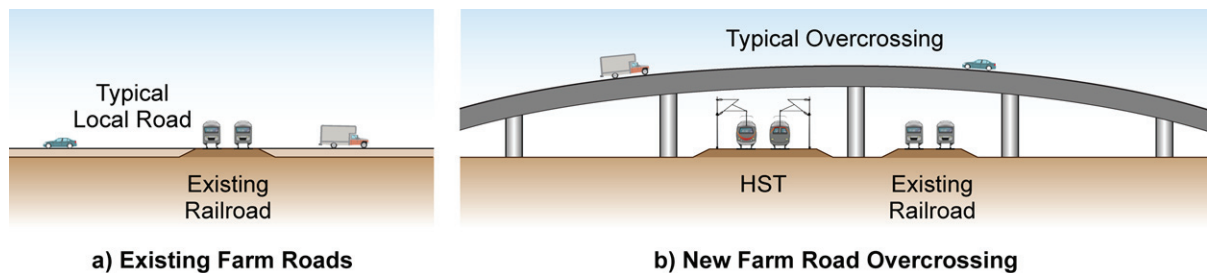

Figure 2-10a
 Replacing Local At-Grade Crossings with New Overcrossings
 above HST Guideway and Existing Railroad Trackway

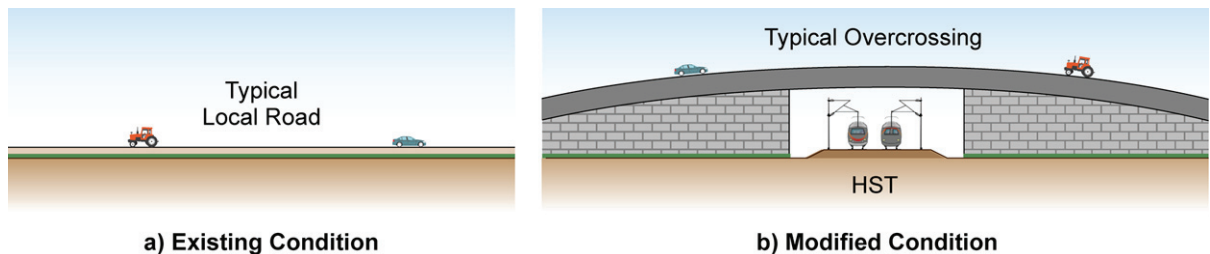

Figure 2-10b
 Adding Local Roadway Overcrossings above HST Guideway

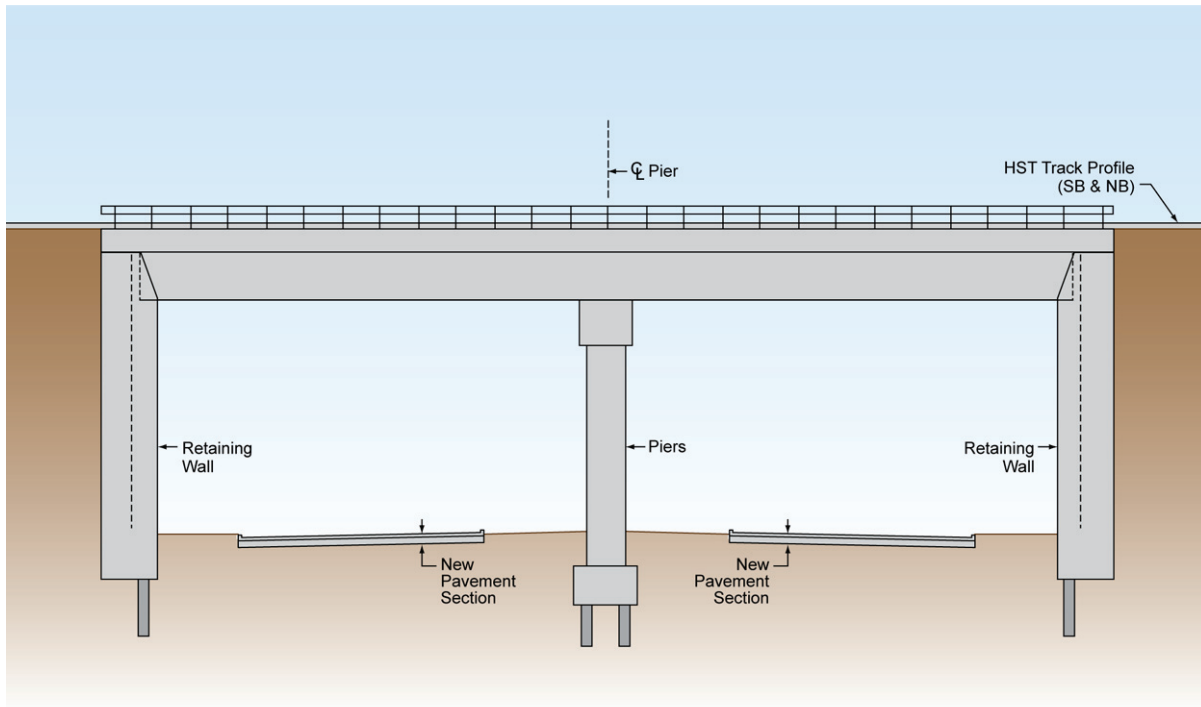

Figure 2-11
 Typical Cross Section of Roadway Grade-Separated Beneath HST Guideway

2.2.6 Railroad Wye

Another component of HST tracks is how the tracks are configured to change directions. The transition to a wye would require splitting two tracks into four tracks crossing over one another before the wye legs can diverge in opposite directions to allow bidirectional travel. Based on HST design criteria, this transition would require approximately 2 miles, with an estimated 120-foot-wide right-of-way for the transition before the tracks have fully diverged from each other. Figure 2-12 provides a diagram showing how the wye would transition the HST from the east-west alignment to the north-south direction. As shown, some of the tracks must cross over the opposite northbound or southbound track.

According to the HST design criteria, the rail might first have to angle away from the through track so that the crossing angle can be sharp. Figure 2-13 shows an example of an HST guideway crossing another leg of the HST track. Figure 2-14 shows a typical section of a mainline two-track line (in the middle) next to two diverging single-tracks, which happens at an elevated wye junction.

Railroad Wye Connections

The Merced to Fresno Section is unique in that it would connect to three other HST sections:

- Merced to Sacramento Section – north of Merced
- Fresno to Bakersfield Section – south of Fresno
- San Jose to Merced Section – east-west connection, also referred to as the *Pacheco Pass connection*

Only the connection between the east-west alignment of the San Jose to Merced Section (i.e., Pacheco Pass connection) and the north-south alignment of the Merced to Fresno Section would require a railroad wye.

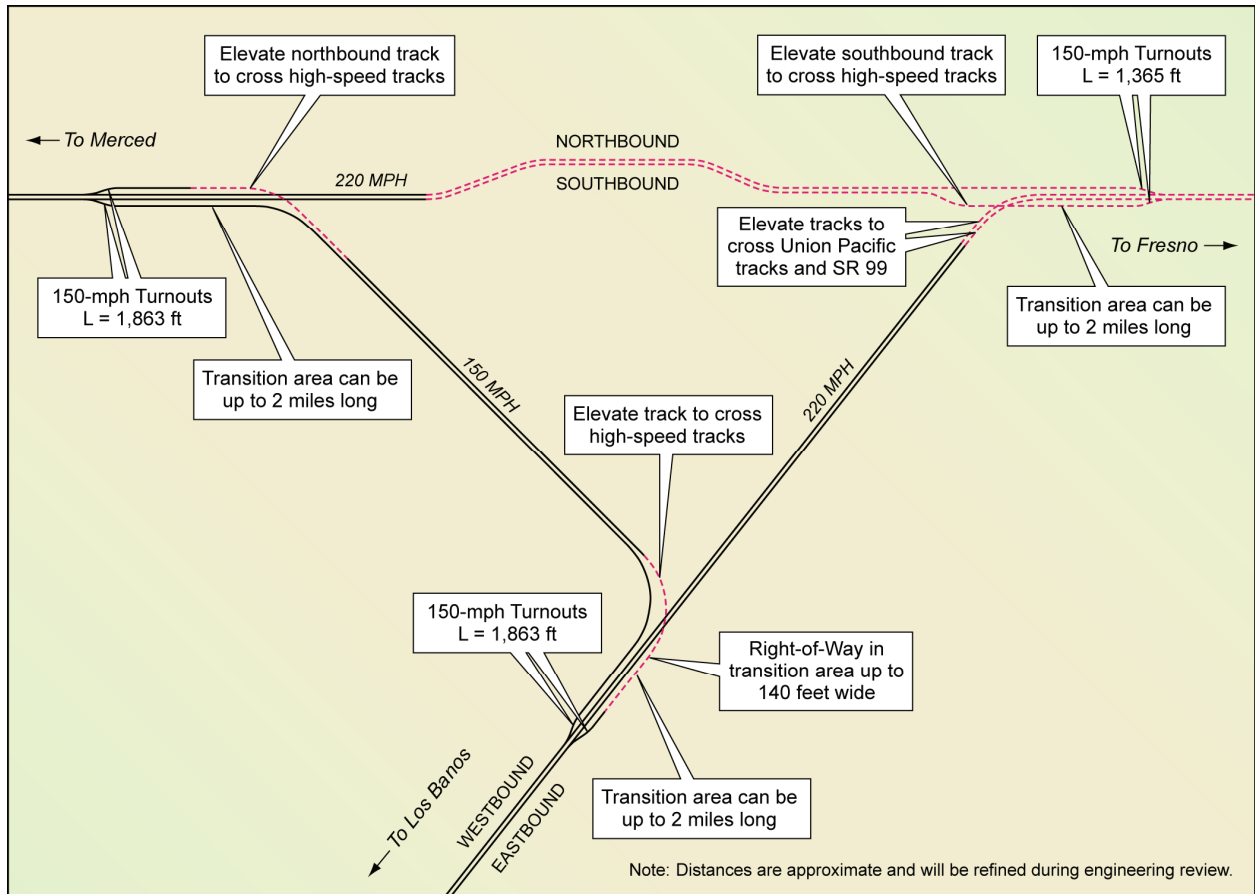

Figure 2-12
 Diagram of a Wye Formation



Figure 2-13
 Photograph Showing Leg of Wye Crossing over
 Another HST Track

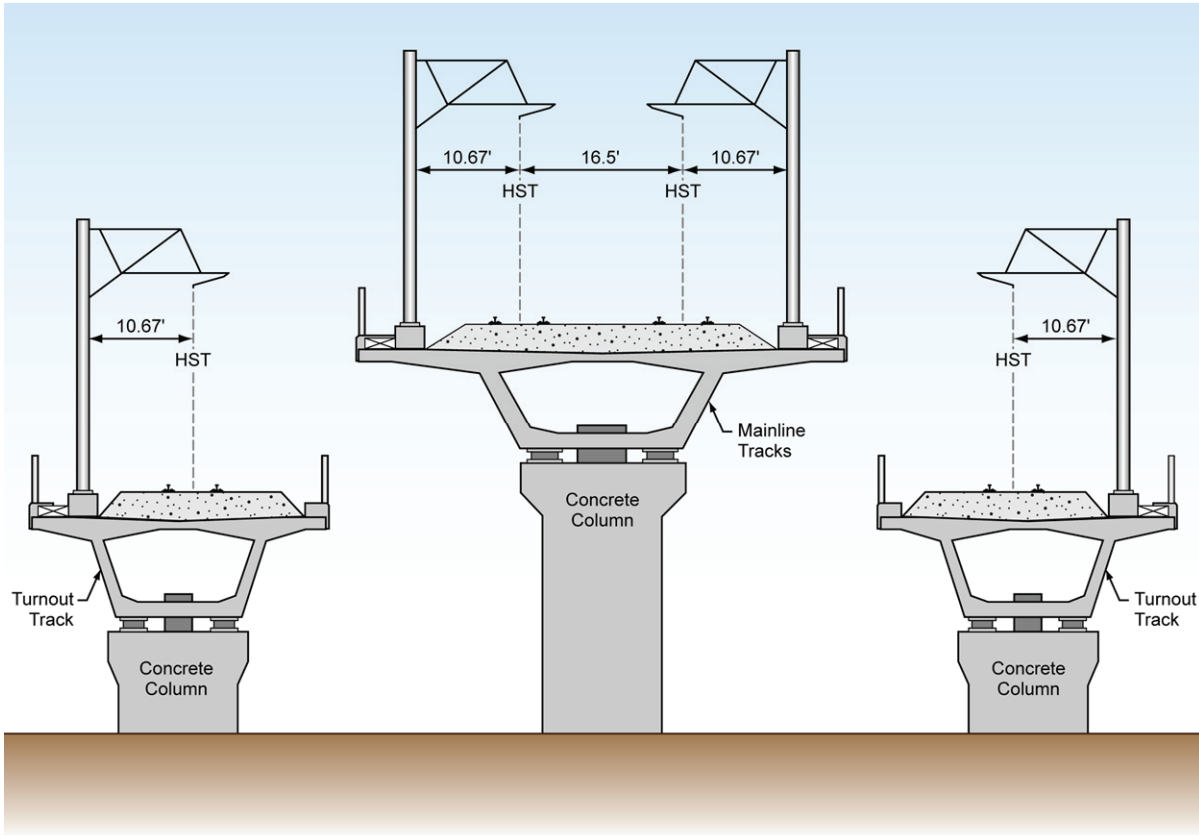

Figure 2-14
 Elevated Four-track Segment at Wye Turnouts

2.2.7 Traction Power Distribution

California’s electricity grid would power the proposed HST System. The HST System is expected to require less than 1% of the state’s future electricity demand. In 2008, a study performed by Navigant Consulting, Inc. found that, while the HST would be supplied with energy from the California grid and it is not feasible to physically control the flow of electricity from particular sources (Navigant Consulting 2008), it would be feasible for the Authority to obtain the quantity of power required for the HST from 100% clean, renewable energy sources through a variety of mechanisms, such as paying a clean energy premium for the electricity consumed.

The project would not include the construction of a separate power source, although it would include the extension of power lines to a series of power substations positioned along the HST corridor. These power substations are needed to even out the power feed to the train system.

Trains would draw electric power from a catenary system fed through an overhead contact system, with the running rails acting as the other conductor. The catenary system would consist of a series of mast poles approximately 23.5 feet higher than the top of rail, with contact wires suspended from the mast poles between 17 to 19 feet from top of rail. The train would have an arm, called a pantograph, to maintain contact with this wire to provide power to the train. The mast poles would be spaced approximately every 200 feet along straight portions of the track

Options for Supplying Power to the HST Substations

Option 1: Construction of transmission lines from the nearest electrical substation to an HST supply station along the Merced to Fresno Section.

Option 2: Construction of an electrical substation at a location where high voltage power lines cross the HST alignment. This substation would include the equipment required for the HST supply station.

down to every 70 feet in tight-turn track areas. The catenary system would be connected to the substations, required at approximately 30-mile intervals. Statewide, the power supply would consist of a 2-by-25-kilovolt (kV) overhead contact system for all electrified portions of the statewide system. See Figure 2-3, which shows a typical overhead contact system.

2.2.7.1 Traction Power Substations

Based on the HST System’s estimated power needs, traction power substations (TPSSs) would each need to be approximately 32,000 square feet (200 feet by 160 feet) and located at approximately 30-mile intervals. Figure 2-15 shows a typical TPSS.

TPSSs would have to accommodate the power supply stations and would require a substantial buffer area around them for safety purposes. The TPSS could be screened from view with a wall or fence. Each TPSS site would have a 20-foot-wide access road (or easement) from the street access point to the protective fence perimeter at each parcel location. Each site would require up to a 2-acre parcel. Each substation would include an approximately 450-square-foot control room (each alternative design includes these facilities, as appropriate).



Figure 2-15
 Traction Power Substation

2.2.7.2 Switching and Paralleling Stations

Switching and paralleling stations work together to balance the electrical load between tracks, and to switch power off or on to either track in the event of an emergency. Switching stations (Figure 2-16) would be required at approximately 15-mile intervals, midway between the TPSSs. These stations would need to be approximately 9,600 square feet (120 feet by 80 feet). Paralleling stations (Figure 2-17) would be required at approximately 5-mile intervals between the switching stations and the TPSSs. The paralleling stations would need to be approximately 8,000 square feet (100 feet by 80 feet). Each station would include an approximately 450-square-foot (18 feet by 25 feet) control room. TPSS, traction power supply switching, and paralleling stations are included in each alternative design as appropriate.



Figure 2-16
 Switching Station

2.2.7.3 Back-up and Emergency Power Supply Sources

During normal system operations, power would be provided by the local utility service and/or from the TPSS. Should the flow of power be interrupted, the system would automatically switch to a back-up power source, through use of an emergency standby generator, an uninterruptable power supply, and/or a DC battery system.



Figure 2-17
 Paralleling Station

For the Merced to Fresno Section HST Project, permanent emergency standby generators are anticipated to be located at passenger stations and at the heavy maintenance facility (HMF) and terminal layup/storage and maintenance facilities. These standby generators are required to be tested (typically once a month for a short duration) in accordance with National Fire Protection Association (NFPA) 110/111 to ensure their readiness for back-up and emergency use. If needed, portable generators could also be transported to other trackside facilities to reduce the impact to system operations.

2.2.7.4 Signaling and Train Control Elements

Signaling and train control elements include small signal huts/bungalows within the right-of-way that house signal relay and microprocessor components, cabling to the field hardware and track, signals, and switch machines on the track. These would be located in the vicinity of track switches, and would be grouped with other power, maintenance, station, and similar HST facilities where possible.

2.2.8 Track Structure

The track structure would consist of either direct fixation system (with track, rail fasteners and slab) or ballasted track, depending on local conditions and decisions to be made in later design. Ballasted track requires more frequent maintenance than slab track, as described below, but is less expensive to install.

2.2.9 Maintenance Facilities

California’s HST System includes three types of maintenance facilities. Each section would have maintenance-of-way facilities. A number of overnight layover and servicing facilities would be distributed throughout the system. In addition, the system would have a single HMF. Descriptions of each follow.

2.2.9.1 Maintenance-of-Way Facilities

Maintenance-of-way facilities provide for equipment, materials, and replacement parts storage, and support quarters and staging areas for the HST System subdivision maintenance personnel. Each subdivision would cover about 150 miles; the maintenance-of-way facility would be centrally located in the subdivision, no more than 75 miles in each direction.

Maintenance-of-Way
 A train industry term that refers to repair and maintenance activity concerning the right-of-way and track, including track and roadway, buildings, signals, and communication and power facilities.

The facility would sit on a linear site adjacent to the HST tracks with a maximum width of two tracks, and would be approximately 0.75 mile long for a total size of 26 acres. One maintenance-of-way facility would be necessary in the Merced to Fresno Section. This facility might be located within the HMF if such a facility were reasonably close to Merced. Additionally, for lengths of mainline track that are relatively distant from stations and/or maintenance-of-way facilities, a refuge track would be sited to provide temporary storage of work trains as they perform maintenance in the vicinity of the track. The track would be approximately 1,600 feet long, would not have electric power, and would be connected to the main line. Access by road for work crews would be required, along with enough space to park work crew vans while working from the site and to drive the length of the track. The track and access area would be within the fenced and secure area of the HST line. In the Merced to Fresno Section, no such refuge track would be required.

2.2.9.2 HST Heavy Maintenance Facility

An HST rail heavy vehicle maintenance and layover facility is proposed to be located in either the Merced to Fresno Section or Fresno to Bakersfield Section. This facility would require approximately 154 acres with space for all activities associated with train fleet assembly, disassembly, and complete rehabilitation; all on-board components of the trainsets; and overnight layover accommodations and servicing facilities. The site would include a maintenance shop, yard Operations Control Center building, one TPSS, other support facilities, and a train interior cleaning platform. Figure 2-18 shows a conceptual HMF layout. The

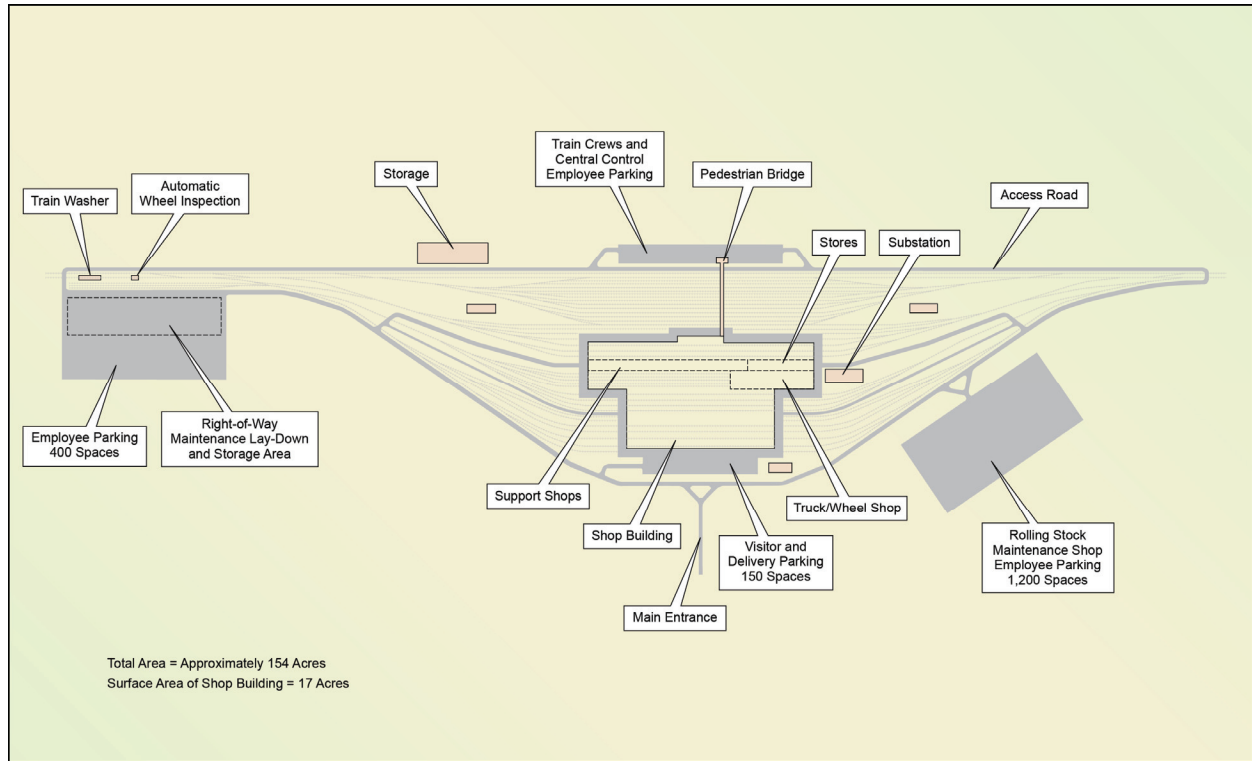

Figure 2-18
 Conceptual HMF Layout

property boundaries for each HMF site would be larger than the acreage needed for the actual facility, due to the unique site characteristics and constraints of each location.

The HMF would have two functions. First, it would support train arrival, assembly, testing, and commissioning to operations. Later, the HMF would become the state's system-wide heavy maintenance workshop. The HMF is likely to support the following functions:

- **Assembly, Testing, and Commissioning:** During the pre-revenue service period, the HMF would be used for the assembly, testing, acceptance, and commissioning of the HST System's new trains. Implementation of the testing, acceptance, and commissioning activities would require a mainline test track between 80 and 105 miles in length, connected directly to the HMF. This would also accommodate the equipment decommissioning or retirement of equipment from the system to make way for the future generations of trains.
- **Train Storage:** Some trains would be stored at the HMF prior to the start of revenue service.
- **Service Monitoring:** Service monitoring would include daily train testing and diagnostics of certain safety sensitive apparatus on the train in addition to automatic on-board and on-ground monitoring devices.
- **Examinations in Service:** Examinations would include inspections, tests, verifications, and "quick" replacement of certain train components on the train. Examples include inspection and maintenance tasks associated with the train's running gear, bogies, underbody elements, and pantographs.
- **Inspection:** Periodic inspections would be part of the planned preventive maintenance program requiring specialized equipment and facilities. Examples include examination of interior fittings and all train parts, passenger environment, in-depth inspection of axles and underbody components critical to train safety, and/or wheel condition diagnostics and re-profiling (wheel truing).

- **Rolling Stock Modifications and Accident Repair:** Rolling stock modifications and accident repair would include major design modifications for improving safety, reliability, and passenger comfort.
- **Overhaul:** Part of planned life cycle maintenance program, overhauls require a specialized heavy maintenance shop with specific heavy-duty equipment. Activities would include the complete overhaul of train components. Overhauls would be completed on each trainset every 7 to 10 years (30 days per trainset) and mid-life overhauls would be performed on each trainset every 15 to 20 years (45 days per trainset).

The HMF would require approximately 154 acres, including buildings, outdoor service areas, storage, roadways, and parking. The proposed HMF sites are centrally located along the HST System to accommodate direct connection with 80 to 105 miles of high-speed mainline test track for HST fleet testing, acceptance, and commissioning. A single, gated entry would control access to the HMF. A two-way, 24-foot-wide circulation road would follow the facility’s interior perimeter and a 50-foot-wide asphalt apron would surround the main shop building to provide emergency vehicles access to the structure.

About 1,200 to 1,500 employees could be accommodated during peak shifts, including overlapping personnel departures and arrivals. The HMF would require parking for approximately 1,200 vehicles based on an estimate of 80% automobile share, and assuming 20% of employees would use public transportation or ride-share. In addition, up to 150 parking spaces near the facility would be available for management and administrative personnel, visitors, deliveries, and parking. Some crew, rolling stock preparation personnel, and train yard employees would park their vehicles near the yard tracks. Thus, the plan would include spaces for approximately 50 crew, 50 rolling stock preparation personnel, and 150 yard support employees at full build-out². A pedestrian bridge over the train yard tracks would connect the employee parking lot to the main shop building. In the Merced to Fresno Section, five potential HMF sites are under consideration.

2.2.9.3 Operations Control Center

The HMF could house the Operations Control Center on the second floor, and would provide space for employee parking, pedestrian access/egress, and appropriate bathroom and lunchroom facilities. Housing the Operations Control Center in the HMF would minimize costs and impacts because it would not increase the HMF’s footprint or require a separate building. If not housed on the HMF site, the Operations Control Center would be housed in an office building where adequate and reliable electronic data connections could be provided for up to 200 employees.

Alternatives Analysis Reports Available for Public Review

The Alternatives Analysis, including the preliminary and supplemental reports, are available on-line at:
www.cahighspeedrail.ca.gov/lib_Merced_Fresno.aspx

2.3 Potential Alternatives Considered during Alternatives Screening Process

Following the decisions of the Program EIR/EIS documents (see Section 1.5, Tiered Environmental Analysis), the Authority, in cooperation with FRA, began the environmental review process for the Merced to Fresno Section of the California HST Project; the environmental review process includes a Notice of Intent (published in 2008) and an agency and public scoping process. Public and agency comments received during the Merced to Fresno HST Project EIR/EIS scoping period and through interagency coordination meetings also informed the development of initial alternatives for the screening evaluation. After analysts identified the initial group of potential alternatives, they developed alignment plans,

² The HMF would be built to meet the necessary requirements for rolling stock and a variety of maintenance activities needed. The entire site would be acquired, but the internal functions may be constructed over time.

preliminary profile concepts, and cross sections. The Merced to Fresno Section design criteria dictate 220-mph designs throughout the system with few exceptions. The Merced to Fresno Section also is one of two HST sections with sites under consideration for the HMF where the HSTs would be assembled and tested. The trains need to be tested for up to 2 years prior to operation. The following summarizes the Merced to Fresno Section alternatives development and analysis process and results.

2.3.1 HST Project-Level Alternatives Development Process

An EIR/EIS is required to analyze the potential impacts of the full range of reasonable alternatives (14 CCR 15126.6, 40 CFR 1502.14[a]). Under CEQA, the alternatives are to include a No-Project alternative and a range of potentially feasible alternatives that would (1) meet most of the project's basic objectives and (2) avoid or substantially lessen one or more of the project's significant adverse effects. (14 CCR 15126.6[c]). In determining the alternatives to be examined in the EIR, the lead agency must describe its reasons for excluding other potential alternatives. Under the "rule of reason," an EIR is required to study a sufficient range of alternatives in order to permit a reasoned choice (14 CCR 15126.6[f]). It is not required that all possible alternatives be studied.

Under NEPA, the alternatives analysis "is the heart of the environmental impact statement" (40 CFR 1502.14). Accordingly, the EIR/EIS examines the range of reasonable alternatives to the proposed action, including the no action alternative. Pursuant to Section 14(l) of the FRA's Procedures for Considering Environmental Impacts, these included "all reasonable alternative courses of action which could satisfy the [project's] purpose and need" (64 FR 28546, May 26, 1999). Throughout the alternative analysis process, the Authority and FRA considered the input of the public and interested resource agencies when developing the reasonable range of alternatives. Pursuant to NEPA and CEQA, scoping meetings were held to invite public participation in defining the scope of the analysis, including the range of reasonable alternatives.

The development of a reasonable range of project-level alternatives followed the process described in *Alternatives Analysis Methods for Project EIR/EIS, Version 2* (Authority 2009b). The assessment of potential alternatives involved both qualitative and quantitative measures that address applicable policy and technical considerations. These included field inspections of corridors; project team input and review considering local issues that could affect alignments; qualitative assessment of constructability, accessibility, operations, maintenance, right-of-way, public infrastructure impacts, railway infrastructure impacts, and environmental impacts; engineering assessment of project length, travel time, and configuration of key features of the alignment, such as the presence of existing infrastructure; and GIS analysis of impacts to farmland, water resources, wetlands, threatened and endangered species, cultural resources, current urban development, and infrastructure. Specific decision criteria under Section 404(b)(1) include Consistency with Project Purpose; Logistics and Technology; Impacts on Aquatic Resources, Environmental Effects (including on national wildlife refuges, parklands, cultural resources, agricultural resources, and displacements of residences and commercial and industrial facilities); Agency, Stakeholder, and Public Positions; and Benefits of Alternative.

The potential alternatives were evaluated against HST system performance criteria. Screening included environmental criteria to measure the potential effects of the proposed alternatives on the natural and human environment. The land use criteria measured the extent to which a station alternative supports transit use; is consistent with existing adopted local, regional, and state plans; and is supported by existing and future growth areas. Constructability measured the feasibility of construction and the extent to which right-of-way is constrained. Community impacts measured the extent of disruption to neighborhoods and communities, such as potential to minimize (1) right-of-way acquisitions, (2) dividing an established community, and (3) conflicts with community resources. Environmental resources and quality measured the extent to which an alternative minimizes impacts on natural resources.

2.3.2 Range of Potential Alternatives Considered and Findings

Figure 2-19 shows the full range of potential route alternatives and corresponding locations of stations and HMFs that were considered during the alternatives development and analysis process. These

included five primary north-south routes between Merced and Fresno, four station alternatives for the Merced Station, two station alternatives in Chowchilla and Madera, and another six alternatives for the Fresno Station. The alternatives analysis also considered five options for the west connection from the San Jose to Merced Section, which will influence the ultimate HST track design of the north-south route (see Figure 2-19).

Scoping comments brought up alternatives that were already considered in the 2005 Statewide Program EIR/EIS, such as the Sierra Foothills (located 8 miles east of SR 99) and an alignment along the I-5 corridor. The Sierra Foothills Alternative was already eliminated in the Program EIR/EIS due to lack of connectivity with urban centers, inability to generate adequate revenue, and high environmental impacts.

The potential for an I-5 alignment was considered and rejected for further study in decisions by the Authority and the FRA on the 2005 Final Statewide Program EIR/EIS. While the I-5 corridor could possibly provide better end-to-end travel times compared with alignment alternatives that generally follow the rail corridors or the SR 99 corridor, it would not meet project objectives and would not satisfy the project's purpose and need as well as the BNSF/UPRR/SR 99 corridors would. Because it is not where the bulk of the Central Valley population resides, the I-5 corridor would result in lower ridership and would not meet the current and future intercity travel demand generated by the Central Valley communities. The I-5 corridor would not provide transit connections in this area, and thus would not meet the purpose and need and basic objectives of maximizing intermodal transportation opportunities and improving the intercity travel experience in the Central Valley area of California. Use of the I-5 corridor would also encourage sprawl development, which is the opposite of what the HST system is intended to achieve, and which was opposed by numerous agencies, including the US EPA.

In contrast to the lower population along the I-5 corridor, almost 5 million residents are projected to live between Merced and Bakersfield along the BNSF/UPRR/SR 99 corridors by 2035. Residents along the BNSF/UPRR/SR 99 corridors lack a competitive transportation alternative to the automobile, and the detailed ridership analysis showed that they would be ideal candidates to use an HST system (Authority and FRA 2011a). In addition, the I-5 corridor would not be compatible with current land use planning in the Central Valley, which focuses and accommodates growth in the communities along the BNSF/UPRR/SR 99 corridors. The concept of linking the I-5 corridor to Fresno and Bakersfield with spur lines was also considered at the program level, but dismissed because it would add considerably to the I-5 corridor capital costs and would still have the same lower ridership figures when compared to the SR 99 corridor.

The alternatives analysis process then evaluated design options within the individual alternatives in order to isolate concerns, and screen and refine the overall alternative to avoid key environmental issues or improve performance. The stations, the west connection options from San Jose, and the north-south alignment between Merced and Fresno were each evaluated separately first.

Of the four alternative station sites evaluated for the Merced HST station, the Downtown Merced Station best satisfied purpose and need. It has the best access to the regional highway and public transit system, and has the fewest residential impacts. The station is proposed adjacent to the UPRR right-of-way in Downtown Merced. In Fresno, the Downtown Fresno Station options are on the west of UPRR located approximately between Tulare and Inyo Streets. This station would be in the business district and would connect with existing transit facilities, including the Greyhound station. The remaining three Merced HST station sites were dismissed for the following reasons:

- The Merced Airport Station site is not adjacent to any of the proposed alternatives; development potential is limited by airport contours; and the station location is not supported by planning efforts in Merced.

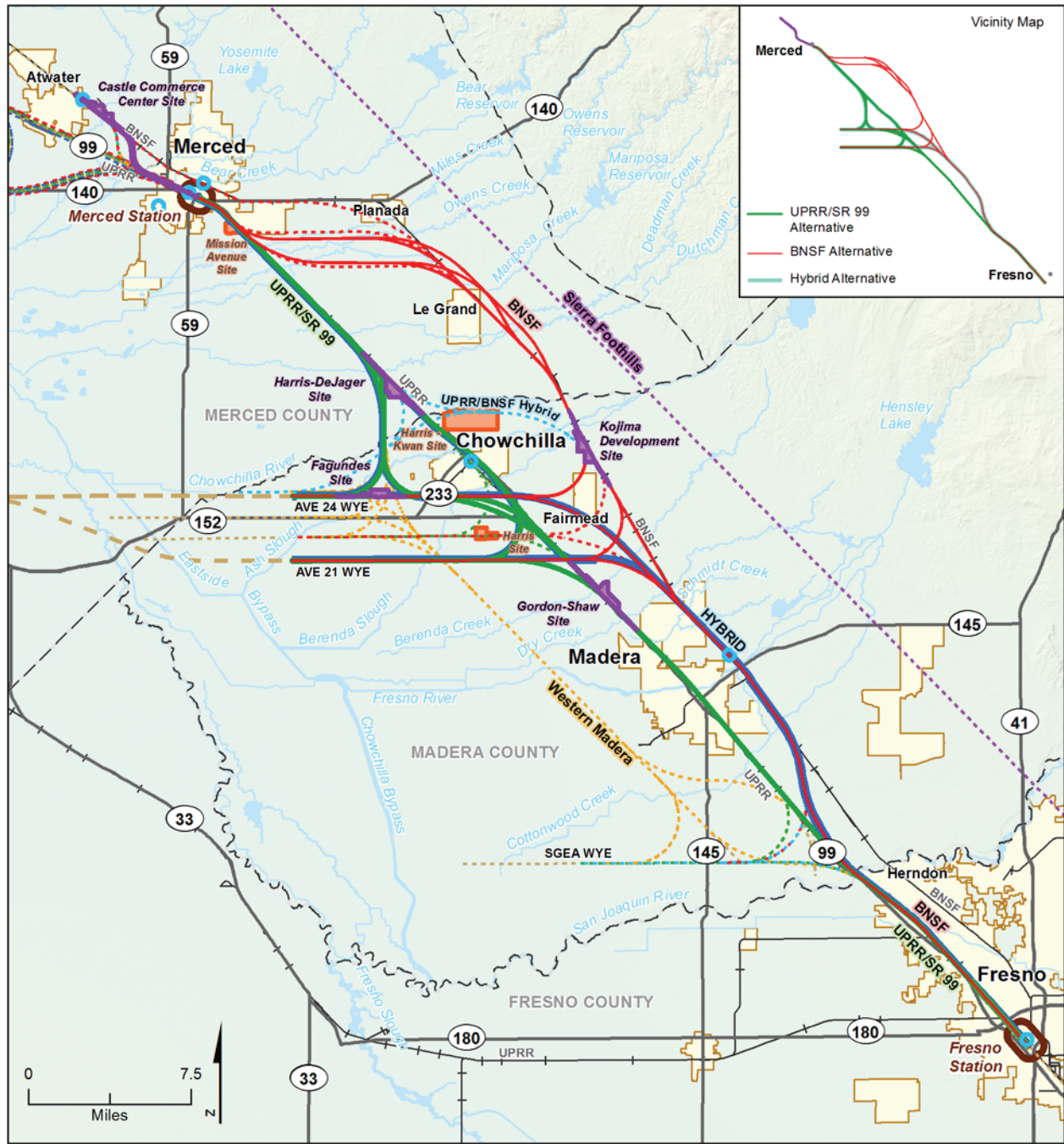

MF_EIS_PD_25 Jul 08, 2011

- | | | |
|---|--|---|
| <p>Alternatives Carried Forward</p> <ul style="list-style-type: none"> — BNSF Alternative — UPRR/SR 99 Alternative — Hybrid Alternative — Connection to Other Section Station Study Area Potential Heavy Maintenance Facility | <p>Alternatives Not Carried Forward</p> <ul style="list-style-type: none"> BNSF Alternative UPRR/SR 99 Alternative UPRR/BNSF Hybrid Alternative Western Madera Alternative Sierra Foothills Connection to Other Section Potential Station Heavy Maintenance Facility | <ul style="list-style-type: none"> City Limit County Boundary Railroad State / US Highway |
|---|--|---|

Figure 2-19
 Potential Alternatives Considered
 During Screening

- The Castle Commerce Center site is more limited in its ability to serve as a multimodal center than the Downtown Merced Station; limited residential density opportunities would limit the site's potential as a multimodal center; and access may be constrained due to limited arterial roadways available to the site.
- Land use surrounding the Merced BNSF/Amtrak Station site does not support a transit station. The site is located within a low-density, well-established residential community; arterial access from SR 99 would involve traveling through the City of Merced, degrading the roadway system; the City of Merced does not support the station; and it would conflict with the local plans for this area.

The two stations evaluated in Chowchilla and Madera were dismissed because they would not meet station location needs, and land uses surrounding the sites do not support a transit station.

The evaluation of east-west connections from the San Jose to Merced Section balanced ecological, agricultural, and community avoidance issues against travel time and longer track development. Of the five east-west routes, the two that were carried forward for evaluation in this document are the routes following Avenue 24 and Avenue 21 (refined from the original Avenue 22 option for environmental avoidance purposes). These are referred to as the "Ave 24 Wye" and the "Ave 21 Wye" design options for the Merced to Fresno Section. The remaining three east-west connections were originally dismissed for the following reasons:

- The North Grasslands Ecological Area (NGEA)/SR 140 connection would not meet the project purpose and need criterion for travel speed; would result in high community impacts in Atwater; and would result in high environmental impacts on habitat that supports threatened and endangered species.
- The SR 152 connection would have high cost, high infrastructure impacts, and high community impacts in Chowchilla. (Although originally dismissed, this connection was subsequently carried forward for further evaluation by the San Jose to Merced Section [Authority and FRA 2011b], as discussed at the end of this section; see the Authority website at http://www.cahighspeedrail.ca.gov/Lib_San_Jose_Merced.aspx for more detail.)
- The South Grasslands Ecological Area (SGEA) connection would result in high environmental impacts on habitat that supports threatened and endangered species and would require construction of 22 miles of additional track that duplicates track between Merced and Fresno.

Once components were screened to lowest impacts and highest HST performance, an Alternatives Analysis process compared the alternatives against each other and documented the results. These data provide a relative comparison for the available design conducted at the time of the alternatives analyses. The data are not current with refined engineering design, including additional facilities (e.g., power stations, roadway modifications) and the data for the Ave 22 Wye (South SR 152) have evolved to minimize impacts to become the current Ave 21 Wye design option. Chapter 3 of this Project EIR/EIS reports the current data.

While the Alternatives Analysis process considered multiple criteria, the screening emphasized the project objective to maximize the use of existing transportation corridors and available rights-of-way, to the extent feasible. The north-south alignment alternatives being carried for further study follow the two existing freight corridors of the UPRR and the BNSF.

Those alternatives that were not carried forward had greater direct and indirect environmental impacts and the potential to cause undesirable growth patterns over those alternatives that closely follow existing transportation corridors. In the Preliminary Alternatives Analysis, Western Madera (A3) and UPRR/BNSF Hybrid (A4) alternatives were removed from further consideration because they departed from existing transportation corridors, thereby causing new transportation corridors among highly productive agricultural lands. Doing so would have the potential to reduce the viability of surrounding farmlands, giving way to other uses such as other transportation and utility infrastructure that could result in unwanted and unplanned growth patterns.

The two alternatives identified to be carried forward for further study in the Preliminary Alternatives Analysis are the UPRR/SR 99 and the BNSF alternatives. Later, during the Supplemental Alternatives Analysis, the Authority developed a "Hybrid Alternative" to take better advantage of existing transportation corridors, while reducing impacts on Chowchilla and Downtown Madera. This alternative, as further refined, also has been carried forward for further analysis. These three alternatives and their design options are analyzed in this document. Two wye configurations are shown for informational purposes because, as explained below, the San Jose to Merced EIR/EIS will analyze three wye connections.

The UPRR/SR 99 Alternative (A2) was found to optimize travel time and minimize environmental impacts at the cost of a more elevated profile and potentially more community impacts than the other alternatives.

The BNSF Alternative did not perform as well as the UPRR/SR 99 Alternative in terms of travel time performance and resulted in higher impacts on the natural and residential environment. However, the BNSF Alternative does provide an alternative to the UPRR/SR 99 Alternative that meets the project purpose and need while also adhering to all the project objectives. This alternative's more distant location from several community centers allows the alternative to remain at-grade for most of its distance and to have a lower level of impact on commercial centers compared to the UPRR/SR 99 Alternative.

The Hybrid Alternative also follows transportation corridors but avoids most communities between Merced and Fresno. The Supplemental Alternatives Analysis incorporated this alternative along with the screening of the proposals for an HMF within the Merced to Fresno Section in August 2010. The fundamental requirements for the HMF are defined by two Authority Technical Memoranda: TM 5.1, *Terminal and HMF Guidelines*, and TM 5.3, *Facilities Requirements Summary* (Authority 2009c,d). In November 2009, based on the specific site and facility requirements, the Authority solicited Expressions of Interest (EOIs) from parties between Merced and Bakersfield that could provide proposals for sites where the HMF could be located.

The Merced to Fresno Section of the HST system received eight proposals as shown on Figure 2-19. Five of these sites were carried forward for further analysis in the EIR/EIS, as listed below.

- Castle Commerce Center
- Harris-DeJager
- Fagundes
- Gordon-Shaw
- Kojima Development

Three sites were dismissed from further consideration and were not carried forward into the EIR/EIS. The Mission proposal from Merced was removed due to engineering feasibility constraints, whereas the Harris-Kwan and Harris proposals were eliminated because they required upwards of five additional miles of HST track to access the sites from current HST alternatives under consideration. The property owners of the Harris-DeJager site initially offered their site for consideration during the alternative development process, but withdrew their site from consideration for use as an HMF following release of the Draft EIR/EIS (Kopshever 2011). This EIR/EIS does not select an HMF site. The Hybrid Alternative has HMF site options, the selection of which depends on the east-west wye connection. The subsequent San Jose to Merced Section Final EIR/EIS will select the preferred east-west connection, which may also influence the range of potential HMFs within the Merced to Fresno Section. Additionally, there are several HMFs sites considered in the Fresno to Bakersfield Section EIR/EIS. The preferred HMF site will be identified once additional environmental review is complete by both sections.

More detailed information on potential alternatives preliminarily considered, but not carried forward for full evaluation in the EIR/EIS, can be found in the *Preliminary Alternatives Analysis Report, Merced to Fresno Section High-Speed Train Project EIR/EIS* and the *Supplemental Alternatives Analysis Report, Merced to Fresno Section High-Speed Train Project EIR/EIS* (Authority and FRA 2010a,b), as well as the *Checkpoint B Summary Report* and attachments (Authority and FRA 2011c), letter from Authority and

FRA to EPA and USACE on January 27, 2012 (Subject: Recommendation Regarding Western Madera Alternative (A3) Screening Based on the "HST Merced to Fresno Section Western Madera (A3) Alternative Screening Memorandum Point 1: Waters of the United States Impacts Analysis), and the *Checkpoint C Summary Report* and attachments (Authority and FRA 2012a), available at www.cahighspeedrail.ca.gov. The USACE and EPA concurred with the alternatives carried forward and evaluated in the project-level EIR/EIS (USACE letters dated June 14, 2011, February 21, 2012, March 26, 2012; EPA letters dated June 24, 2011, and March 23, 2012).

Although the SR 152 connection to the San Jose to Merced Section was originally eliminated from detailed study, it was subsequently carried forward for evaluation in the San Jose to Merced Section Project EIR/EIS (Authority and FRA 2011b) based on additional input from regulatory agencies (EPA and USACE). Design refinements to this connection would avoid many of the impacts that led to its original dismissal from consideration. The Authority developed the SR 152 Wye with connections to all three north-south alignment alternatives (see Figure 2-20) to a conceptual-level alignment to be consistent with Caltrans planning, the SR 152 Freeway Agreement, and HST engineering criteria. The three wye configurations are evaluated and compared in the SR 152 Alternatives Analysis (available on the Authority's website at www.cahighspeedrail.ca.gov). This Merced to Fresno Section EIR/EIS does not analyze the SR 152 Wye. All three east-west alignments and wyes (i.e., along Avenue 24, Avenue 21, and SR 152) will be carried forward for additional study and consideration as part of the San Jose to Merced EIR/EIS process.

This approach will allow the Authority and FRA to make a decision on the north-south alignment between Merced and Fresno based on the Merced to Fresno Section Project EIR/EIS, and to make a decision on the east-west alignment and wyes based on the upcoming San Jose to Merced Section Project EIR/EIS.

The SR 152 wye connection, illustrated in Figure 2-20, would parallel SR 152 and would be offset approximately 400 feet from the edge of highway to the HST right-of-way, providing separation from each facility's respective right-of-way boundary. The proposed HST alignment offset 400 feet parallel to SR 152 balances the needs of (1) the Authority to have a safe operating corridor, (2) Caltrans to accommodate future growth, and (3) the overall system to minimize impacts on land owners, Caltrans, and the county. HST alignments closer than 400 feet to SR 152 would result in greater impacts on Caltrans and local agency facilities. HST alignments farther than 400 feet from SR 152 would have greater impacts on agricultural lands and further bifurcate the predominantly agricultural parcels adjacent to SR 152 and the HST. The opportunity resulting from the property remainder will need to be addressed by the Authority, Caltrans, local agencies, and community stakeholders. Preliminary analysis indicates that the SR 152 Wye differs from the Ave 21 and Ave 24 wyes primarily in impacts on agricultural lands and the communities of Chowchilla and Fairmead.

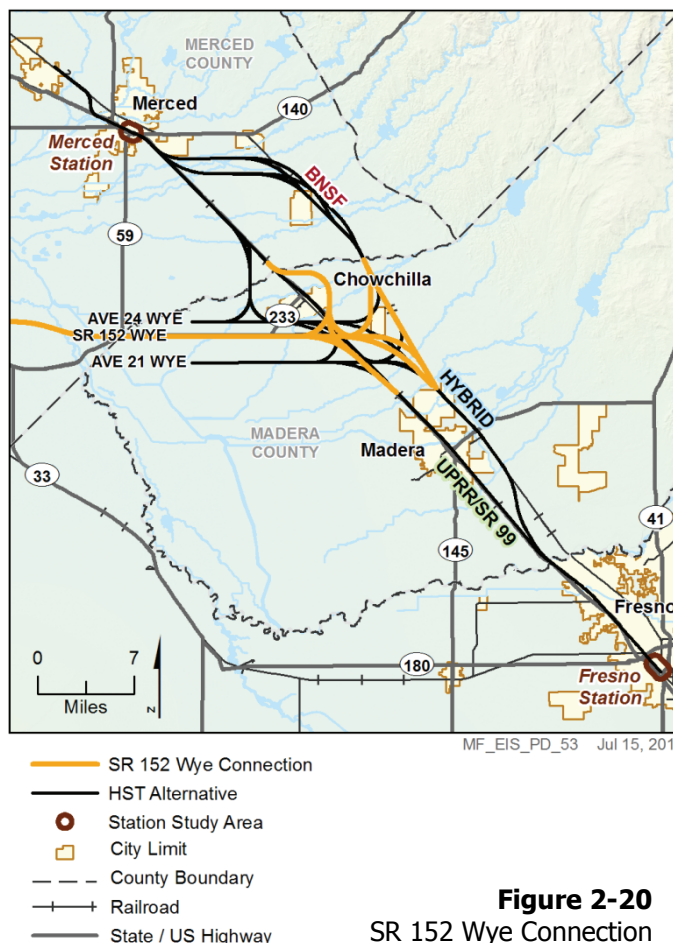

Figure 2-20
 SR 152 Wye Connection

The San Jose to Merced Section Project EIR/EIS will fully evaluate these and the other wye configurations contained in the Merced to Fresno Section Project EIR/EIS so that all wye configurations currently under consideration, including those associated with the SR 152 alignments, are contained in the San Jose to Merced Project EIR/EIS. A decision regarding the preferred east-west connection of the San Jose to Merced Section to the Merced to Fresno Section would take place following circulation of the San Jose to Merced Section Project EIR/EIS in 2013 and a presentation to the Board by Authority staff of a recommended preferred east-west HST alignment.

2.3.3 Summary of Design Features for Alternatives Being Carried Forward

Figure 2-21 illustrates the HST alternatives and the HMF sites evaluated in this Merced to Fresno Section Project EIR/EIS. The Merced to Fresno Section alternatives presented in this EIR/EIS reflect refinements and modifications made to the project design in order to avoid and minimize impacts on known environmental and community resources. The alternatives evaluated in this EIR/EIS represent a 15% to 30% design level. Table 2-2 summarizes the design features included as part of the HST alternatives evaluated.

An important performance measure of each of the alternatives is the travel time between key destinations. The wye plays a major role in achieving the travel time requirements of 2 hours and 40 minutes between San Francisco and Los Angeles Union Station, as well as 2 hours and 20 minutes from Los Angeles Union Station to Sacramento, as mandated by state legislation and Proposition 1A. The following summarizes which alternatives perform the best for which direction and the differences for alternatives that result in longer travel times for that linkage:

- **Between San Francisco and Los Angeles** – The UPRR/SR 99 Alternative with the Ave 21 Wye design option is the shortest distance and the shortest travel time between San Francisco and Los Angeles. The BNSF and Hybrid alternatives with the Ave 21 Wye are about 30 seconds longer. The Ave 24 Wye adds a little over 2 minutes with the UPRR/SR 99 Alternative and 2½ minutes with the BNSF and Hybrid alternatives.
- **Between Merced and Fresno** – The UPRR/SR 99 Alternative (with either wye option) is the shortest and fastest route between Merced and Fresno; the West Chowchilla Design option adds a little less than 1½ minutes and the BNSF Alternative adds a little more than 1½ minutes. The Hybrid Alternative adds approximately 1 minute more with the Ave 21 wye and almost 2 minutes more with the Ave 24 Wye.
- **Between San Francisco and Merced (or further north to Sacramento)** – The UPRR/SR 99 and Hybrid alternatives with the Ave 24 Wye are the shortest and fastest alternatives in the west to northbound direction. Using the Ave 21 Wye would add slightly over 1 minute, but the BNSF Alternative would add 4 minutes for the Ave 24 Wye and 4½ minutes more for the Ave 21 Wye design option.

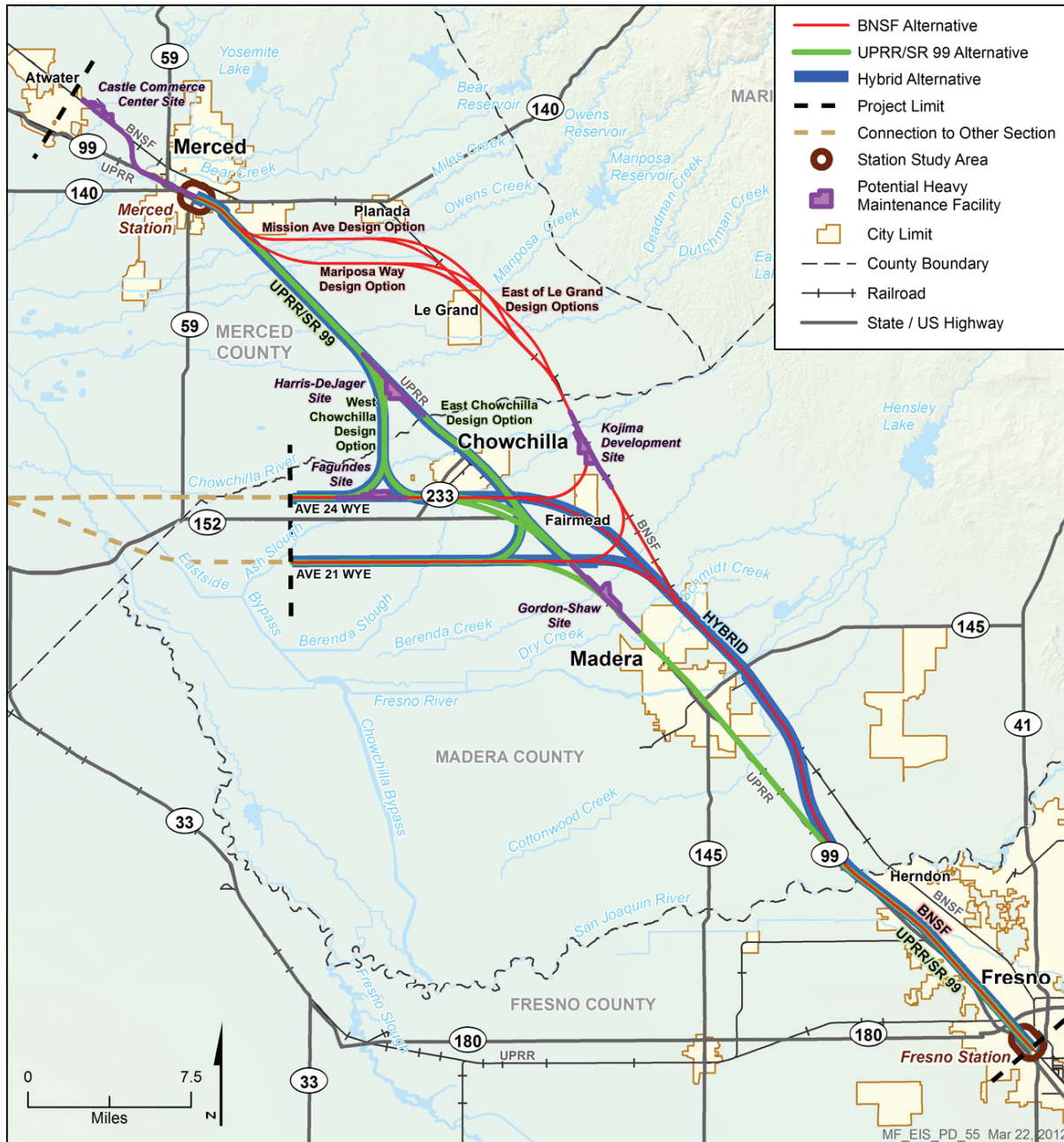

For individual alternative maps, see the figures noted below.

NA = Not Applicable

Wye Connection	UPRR/SR 99 Alternative		BNSF Alternative				Hybrid Alternative
	West Chowchilla Design Option	East Chowchilla Design Option	Mission Ave Design Option		Mariposa Way Design Option		
			Le Grand	East of Le Grand	Le Grand	East of Le Grand	
Ave 24 Wye	2-27a	2-27b	2-44a	2-44b	2-44c	2-44d	2-52a
Ave 21 Wye	NA	2-27c	2-44e	2-44f	2-44g	2-44h	2-52b

Figure 2-21
 HST Alternatives and HMF Sites Carried Forward for Further Study

Table 2-2
 Design Features of Alternatives Carried Forward

Alternative:	UPRR/SR 99 Alternative			BNSF Alternative									
			Hybrid Alternative	Mariposa Way				Mission Ave					
	Design Option:	East Chow-chilla		West Chow-chilla	Le Grand Design Option	East of Le Grand Design Option	Le Grand Design Option	East of Le Grand Design Option					
Wye:	Ave 24	Ave 21	Ave 24	Ave 24	Ave 21	Ave 24	Ave 21	Ave 24	Ave 21	Ave 24	Ave 21	Ave 24	Ave 21
Total length ^a (linear miles)	90	86	74	75	76	94	92	95	93	94	92	95	93
At-grade profile ^a (linear miles)	49	49	43	58	57	69	69	69	69	69	69	69	69
Elevated profile ^a (linear miles) (including retained fill)	41	37	32	17	19	25	23	26	24	25	23	26	24
Number of Straddle Bents ^b	60	78	75	55	40	52	43	52	43	52	43	52	43
Number of Railroad Crossings	9	9	7	6	4	6	6	10	10	6	6	10	10
Number of Water Crossings	98	105	113	113	113	92	97	88	93	104	109	101	106
Approximate Number of Roadway Closures ^c	23	26	32	49	37	74	59	80	65	71	56	77	62
Number of Roadway Overcrossings ^d	29	26	29	47	43	51	43	51	43	51	43	51	43

^a Lengths shown are based on equivalent dual-track alignments. For example, the length of single-track elevated structure will be divided by a factor of 2 to convert to dual-track equivalents.

^b The number of straddle bents was estimated by dividing the preliminary structural span lengths by 100 feet, the assumed spacing between columns/bents. Actual structural configuration to be determined during design.

^c Includes public and private road closures.

^d Includes one roadway overcrossing of an existing road (not HST).

2.4 Alignment, Station, and Heavy Maintenance Facility Alternatives Evaluated in this Project EIR/EIS

This section describes the project-level alternatives carried forward for further analysis and refinement in this Project EIR/EIS, beginning with the No Project Alternative and then continuing to the HST alternatives. As shown in Figure 2-22, the Merced to Fresno Section study area is organized from north to south into four geographic areas to facilitate discussion. The project termini are the Downtown Merced Station and the Downtown Fresno Station. Note that if the Castle Commerce Center, which is north of Merced, were to be selected as the site for the HMF (discussed in detail in Section 2.4.6), the project's northern boundary would be north of Merced at that facility. The Authority's and FRA's Preferred Alternative is identified and further discussed in Chapter 7. The USACE and EPA concurred that the Hybrid Alternative is the preliminary LEDPA (letters from USACE dated March 26, 2012, and from EPA dated March 23, 2012).

The HST alternatives are described below by their three components: the north-south HST alignments between Merced and Fresno, which in some cases include design options; the railroad wye connection to the San Jose to Merced Section; and the stations. Additionally, the project includes associated roadway modifications required to accommodate the HST System. Appendix 2-A provides a detailed list of these, but the modifications (closure, overcrossing, or undercrossing) are shown in maps in the following descriptions. The proposed HMF alternatives are described separately from the three HST north-south alignment alternatives and stations. Appendix 2-B is a map book of the project footprint for all alternatives, including stations, HMFs, and easements needed for power supply.

2.4.1 No Project Alternative—Existing and Planned Improvements

The No Project Alternative considers the effects of growth planned for the region as well as existing and planned improvements to the highway, aviation, conventional passenger rail, and freight rail systems in the Merced to Fresno project area through the 2035 time horizon for the environmental analysis.

2.4.1.1 Planned Growth

The San Joaquin Valley is projected to grow at a higher rate than any other region in California. The three counties—Merced, Madera and Fresno—are projected to continue to grow at an average of 3% per year. Table 2-3 shows the projected growth according to the California Department of Finance for Merced, Madera and Fresno County population and employment growth projections through 2035.

Growth Projections in Merced, Madera, and Fresno Counties

2035 population projections show a need for 274,000 new dwelling units and 91,000 acres of land to accommodate nearly 1 million new inhabitants in the area.

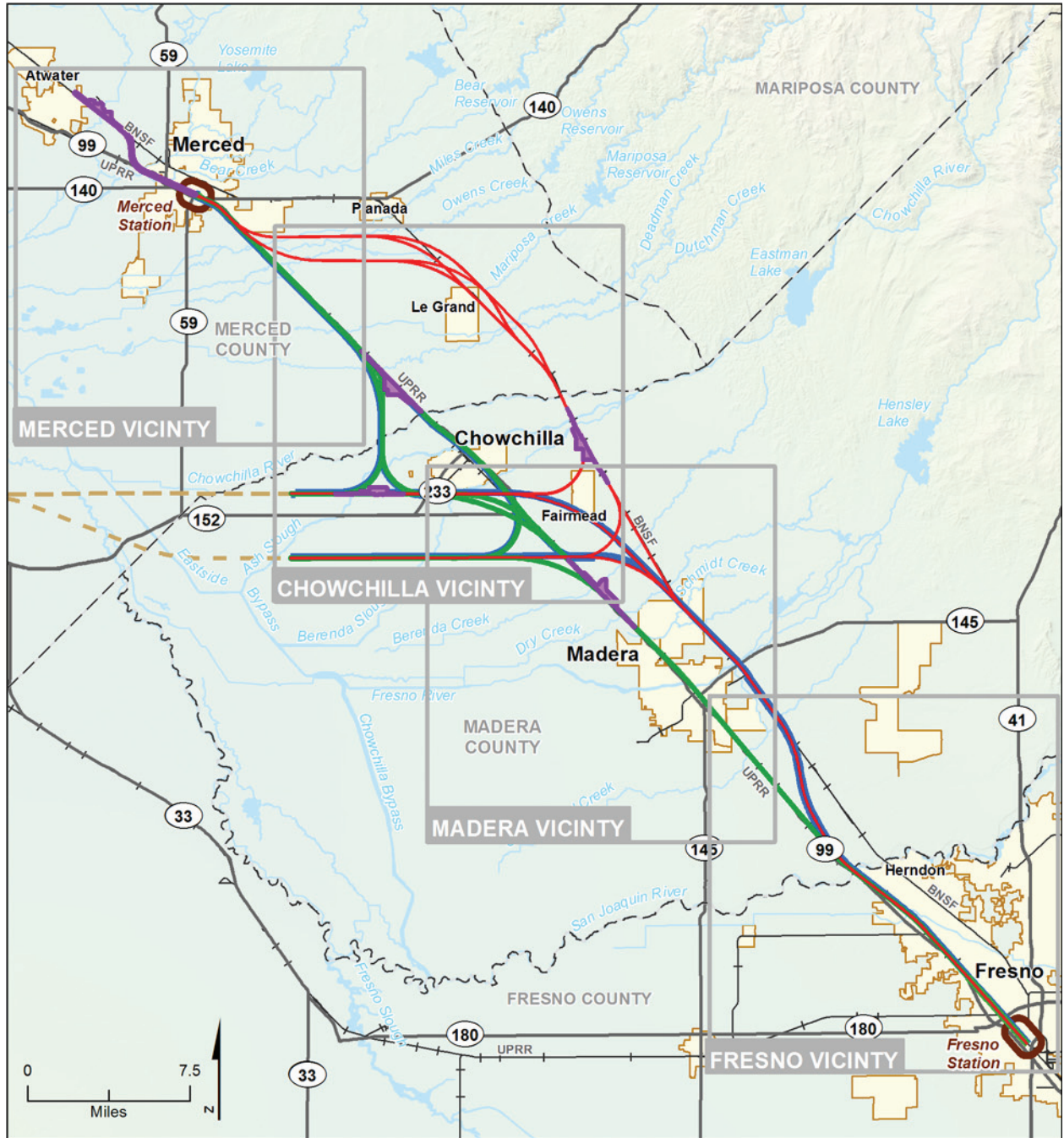

MF_EIS_PD_27 Jun 09, 2011

- | | | |
|---|--------------------------------------|--------------------|
| — BNSF Alternative | Station Study Area | City Limit |
| — UPRR/SR 99 Alternative | Potential Heavy Maintenance Facility | County Boundary |
| — Hybrid Alternative | Vicinity | Railroad |
| — Connection to Other Section | | State / US Highway |

Figure 2-22
 HST Alternatives and
 Project Vicinities

Table 2-3
 Regional Projected Population and Employment

County	2010 Estimates	2035 RTP Projections	Percent Change
Population			
Merced	258,495	465,500	80%
Madera	153,655	313,250	104%
Fresno	953,761	1,519,325	59%
Employment			
Merced	85,200	155,300	82%
Madera	52,822	94,480	79%
Fresno	397,728	618,682	56%
RTP = Regional Transportation Plan – see sources below for RTP Source: CDOF (2010), Madera County Transportation Commission (2010), Merced County Association of Governments (2009). For percent growth inducement, the higher of the two growth inducement rates was taken from Cambridge Systematics (2003) and Cambridge Systematics (2007).			

Despite the current economic downturn, which may temporarily slow growth, by 2035 projections show nearly 1 million new inhabitants and 332,712 new jobs in this area. This would nearly double the current populations in Merced and Madera counties and would add over one-third more people in Fresno County.

In preparation for this project growth, all three counties and several incorporated cities inside these counties are in the process of updating their general plans. Previously, the seven councils of government (COGs) in the San Joaquin Valley engaged in the San Joaquin Valley Blueprint Planning Process for the purpose of examining alternative growth scenarios for the Valley and selecting a preferred scenario to reflect regional partialities for future development patterns. In this process, Merced, Madera, and Fresno county representative COGs reflected on the planning scenarios for their future development strategies. Computer programs modeled results of different land use densities so that the councils could make informed decisions for their future. The following summarizes the conclusions in the San Joaquin Valley Blueprint Planning Process published in September 2010:

- The Merced County Association of Governments adopted a growth scenario of most changes, with densities reaching above 8 dwelling units per acre and focused growth in the cities and along highways.
- The Madera County Transportation Commission preferred a growth scenario referred to as “low change,” which would maintain the average residential density of 4.7 dwelling units per acre.
- The Fresno County Council of Governments preferred a growth scenario of 8 dwelling units per acre, while focusing higher densities in the Fresno-Clovis Metropolitan areas.

Based on the U.S. Census American Community Survey (2010) (Census 2011), which reported that these three counties recorded an average of 3.4 persons per dwelling unit, and then applying the average residential units per acre as listed above, Merced would require nearly 61,000 new dwelling units and almost 7,600 acres of land for housing, Madera would require approximately 47,000 new dwelling units and 10,000 acres of land, while Fresno would require slightly over 166,000 dwelling units and 20,800 acres of land. Collectively, merely for housing, this would result in 38,400 acres of land required to accommodate needed housing. However, this does not take into account commercial, transportation, and

supporting infrastructure such as parks, water treatment, and medical facilities. With necessary supporting infrastructure, including commercial, office, transportation, parks, and schools, a typical density for an area similar to the San Joaquin Valley would result in 8 to 10 people per acre of land development³ (US 36 AADEIS, CDOT 2009). Under this scenario, the total three-county growth projections would result in approximately 91,000 acres of needed development. This becomes the basis for comparing the HST Project alternatives.

The No Project Alternative includes more refined detail on several planned transportation, housing, commercial, and other development projects by the year 2035. Section 3.19, Cumulative Impacts, provides a list of foreseeable future development projects, which include shopping centers, large residential developments, quarries, and planned transportation projects defined in the various regional transportation plans for each of the three counties. Some of the notable, larger planned projects in the regions between Downtown Merced and Downtown Fresno are listed in Table 2-4.

Table 2-4
 Planned Residential Development Plans within the Merced to Fresno Area as of October 2010

General Location	Project Name	Planned Number of Dwelling Units	Total No. of Units
Merced Area	University of California, Merced	1,500	10,552
	Bellevue Ranch ^a	4,500	
	NE Yosemite Specific Plan	2,500	
	South Merced Specific Plan	2,052	
Planada	Planada 15	72	72
Chowchilla	Rancho Calera Specific Plan	2,042	2,042
Fairmead	Fairmead Specific Plan	1,700	1,700
Madera City	SE Madera Development	1,375	1,375
Madera Southeast County Area	Tesoro Viejo Specific Plan	5,190	50,399
	Gunner Ranch West Specific Plan	2,840	
	Gateway Village	5,836	
	North Shore at Millerton Lake	2,966	
	Sierra Meadows	315	
	Liberty Grove Specific Plan	7,500	
	Tra Vigne	432	
	San Joaquin River Ranch	21,954	
	Tathan Specific Plan	9,040	
	Morgan Specific Plan	700	

³ In Denver, the Colorado Department of Transportation studied land use density as part of the preparation for the US 36 Project Alternative Analysis/EIS (2009). The study conducted a GIS analysis of 50 years of land use trends based on historic aerial photos digitized and then measured actual census data to determine that the gross use of an acre of land supported an average of 10 persons.

General Location	Project Name	Planned Number of Dwelling Units	Total No. of Units
	Shaw Specific Plan	996	
	Raymond Area Plan	130	
Fresno ^b	Figarden Mixed Use Building	305	2,905
	West Lake	2,600	
Total			69,045
^a Partially built, estimated remaining units. ^b Fresno projects were only gathered for the northernmost regions of Fresno consistent with the project corridor.			

Table 2-4 only highlights the larger residential development plans. As of October 2010, there are residential plans in various stages of approval in the City and County of Merced that could result in the potential for 10,900 new residential units. In the City and County of Madera, there are nearly 55,516 new residential units planned. Within the project limits of Fresno County, there are slightly over 2,900 new residential units planned. In addition, the City of Fresno’s ongoing general plan update is expected to include the city’s 9,000-acre Southeast Growth Area (SEGA), with the potential to accommodate more than 17,000 dwelling units. Because the general plan update has not been adopted, the potential capacity of the SEGA is not reflected in Table 2-4. Due to the economy, the pace of construction has slowed for much of this development, but the plans are there to accommodate growth as it occurs. Madera County has more residential units (over 50,000 dwelling units) in various stages of approval than the county is projected to need by 2035. These are primarily planned for the areas in the southeast portion of the county, outside the urban growth boundary.

In the north end of the project, Castle Commerce Center has been planning to convert the former Castle Air Force Base into a 552-acre commercial-industrial center, located just north of the City of Merced and adjacent to Atwater. Another key development that anchors the Merced metropolitan areas is the growing University of California, Merced (UC Merced) campus located east of the City of Merced. The newest UC campus is projected to grow from 3,400 students in 2010 to a full buildout of 25,000 students before 2030 according to the 2009 Long Range Development Plan (University of California 2009). The UC Regents have reserved a total of 7,000 acres in which the campus would only occupy 815 acres of a compact development campus. The campus is currently accessed by traveling through Merced arterials, primarily Santa Fe Avenue. The list of these key anchors and the pending development projects illustrate that growth and change on the landscape are evident, yet projects do not communicate the entire development plans through the 2035 horizon.

Taking into account all support uses, infrastructure, and services, the average development patterns in the San Joaquin Valley and Merced, Madera, and Fresno counties would result in the conversion of approximately 20,700, 16,000, and 56,500 acres, respectively, into urban development. However, regardless of development patterns, an increase in population and employment results in an increasing need to travel between destinations. The regional measure for growth in travel patterns is the amount of vehicle miles traveled (VMT) during a year. Between 2010 and 2035, VMT is projected to increase 80% and 90% in Merced and Madera counties, respectively, and 20% in Fresno County. According to the 2010 travel demand analysis conducted by Cambridge Systematics, the three-county region is projected to increase from 35 million to almost 50 million VMT per year by 2035 (Cambridge Systematics 2010).

2.4.1.2 Highway Element

The highway element of the No Project Alternative includes the planned efforts of Caltrans and the three study area counties to address the anticipated growth in VMT and resulting congestion on the roadway system. In 2010, the VMT in Merced and Madera counties are projected at approximately 7.4 million and 4.5 million, respectively. VMT is expected to nearly double by 2035; Table 2-5 shows forecast travel increases by county. In Merced and Madera counties, approximately 70% of all VMT occurs on the state highway system; the VMT on Caltrans routes in Fresno County is 40% of travel.

Table 2-5
 Increase in Total Daily Vehicle Miles Traveled

County	2010 Daily VMT^a	2035 Daily VMT (estimate)^b	Increase in VMT (% of 2010 VMT)
Merced	7,398,932	13,534,370	83
Madera	4,469,260	8,532,552	91
Fresno	23,489,397	27,367,949	17
Total (three counties)	35,357,589	49,434,871	40
^a Source: Caltrans (2009a).			
^b Source: Estimates for the No Project Alternative were prepared by Cambridge Systematics (2007).			

The No Project Alternative includes the funded and programmed improvements on the intercity highway network based on financially constrained RTPs developed by regional transportation planning agencies. Figure 2-23 shows the existing network. Tables 2-6 through 2-8 identify the improvements in the Merced, Madera, and Fresno areas; these tables include map identification numbers that coincide with the numbered improvement projects shown on Figures 2-24 through 2-26.

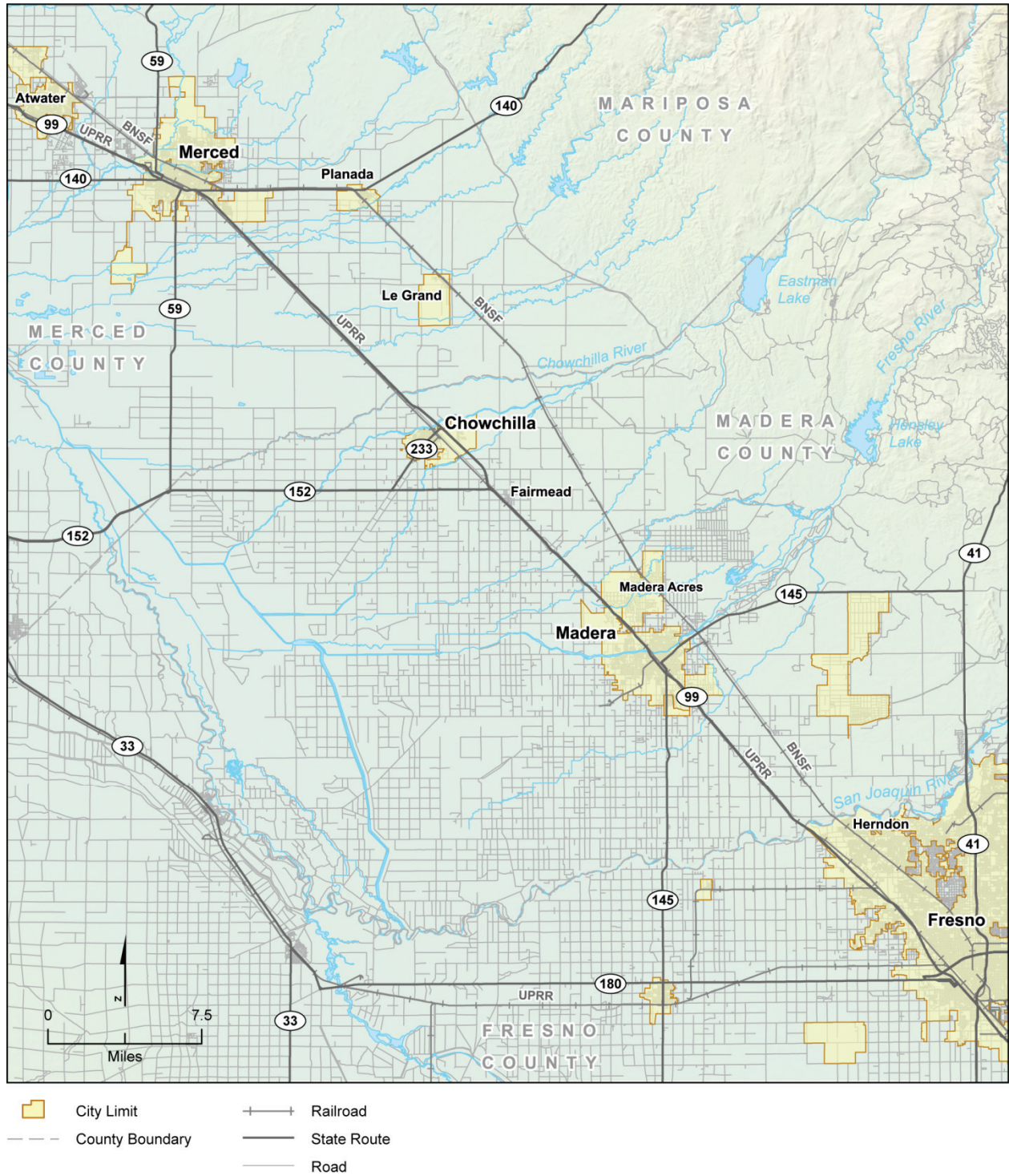

Figure 2-23
 Existing Intercity Transportation Network



Figure 2-24
 No Project Alternative Planned Improvements in Merced

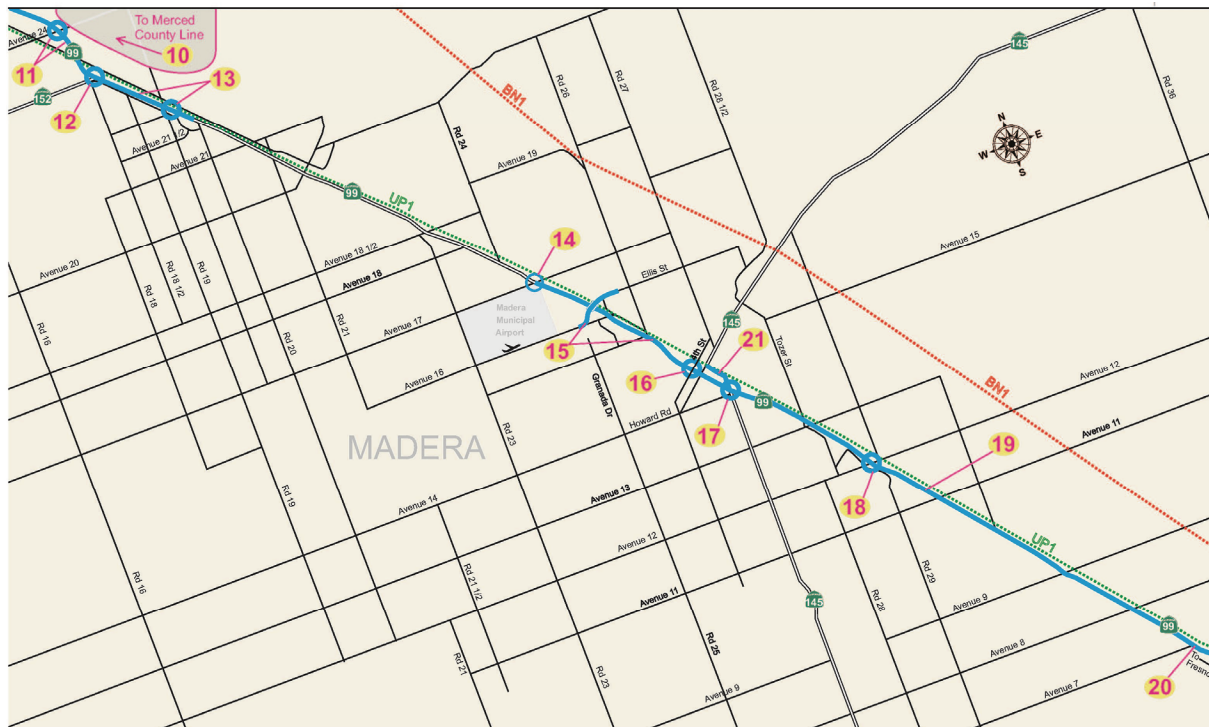
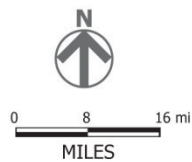

Figure 2-25
 No Project Alternative Planned Improvements in Madera



— Proposed Roadway Improvements
○ Proposed Interchange Improvements

Figure 2-26

No Project Alternative Planned Improvements in Fresno

Table 2-6

No Project Alternative – Planned Highway Improvements in Merced

Location/ Map No. ^a	Routes	Planned Improvements	Project Timeline
1	SR 99	Convert from four- to six-lane freeway between a point north of Atwater and Arena Way; remove at-grade road crossings; construct new interchange at Westside Boulevard (Completed)	Completed Fall 2010
2	SR 99	Widen freeway from four to six lanes from Atwater through downtown Merced; upgrade interchanges in downtown area	2010 to 2016
3	Interchange SR 99 at SR 140	Improve interchange safety (Completed)	Completed in 2010
4	Interchange SR 99 at Mission Avenue	Construct new interchange (Completed)	Completed in 2010

Location/ Map No. ^a	Routes	Planned Improvements	Project Timeline
5	SR 99	Convert from four- to six-lane freeway between McHenry Road and Buchanan Hollow Road; eliminate at-grade road crossings; construct new interchange at Arboleda Road	Construction to begin in Spring 2012
6	SR 99	Convert from four- to six-lane freeway between Buchanan Hollow Road and Merced/Madera County line; eliminate at-grade road crossings; construct new interchange at Plainsburg Road	Construction to begin in Fall 2012
7	Atwater-Merced Expressway	Construct new four-lane expressway between SR 140 and SR 59; realign SR 59; remove at-grade road crossings; construct new interchange at SR 99 and Santa Fe Avenue	After 2012
8	SR 140	Upgrade arterial from Parsons Avenue to Tower Road	Right-of-way Acquisition 2010
9	Campus Parkway	Construct Campus Parkway between SR 99 and Yosemite Avenue in Madera County (Completed)	Completed December 2010
^a See Figure 2-23 to cross reference the planned improvement.			

Table 2-7
 No Project Alternative – Planned Highway Improvements in Madera

Location/ Map No. ^a	Routes	Planned Improvements	Project Timeline
10	Interchange SR 99 at SR 233	Reconstruct interchange	Open to traffic 2024
11	SR 99	Convert to six-lane freeway between Merced/Madera County line and SR 152; reconstruct interchange at Avenue 24	2017 to 2018 ^b
12	Interchange SR 99 at SR 152	Construct new interchange and rail crossing	2019 to 2020 ^b
13	SR 99	Widen freeway between SR 152 and south of Avenue 21½; construct interchange at Avenue 22	Constructed (per Caltrans District Route 99 Business Plan, 9/2009)
14	SR 99	Convert to six-lane freeway between Avenue 17 and Ellis Street; reconstruct interchange at Avenue 17	Interchange improvements – Open to traffic 2025; SR 99 improvements – open to traffic 2024

Location/Map No. ^a	Routes	Planned Improvements	Project Timeline
15	SR 99	Convert to six-lane freeway between Ellis Street and Avenue 12; reconstruct interchange at Ellis Street	Ellis Street Interchange – Unconstrained capacity-increasing project that cannot be funded within the 25-year time frame (Madera County 2011 RTP, 7/11/2010); SR 99 improvements – open to traffic 2024
16	Interchange SR 99 at 4 th Street	Reconstruct interchange	Open to traffic 2012 ^b
17	Interchange SR 99 at SR 145	Improve interchange	Open to traffic 2032
18	Interchange SR 99 at Avenue 12	Reconstruct interchange	Open to traffic 2017
19	SR 99	Convert to six-lane freeway between Avenue 12 and Avenue 7	Open to traffic 2026 ^c
20	SR 99	Convert to six-lane freeway between Avenue 7 and Fresno County line	Open to traffic 2017

^a See Figure 2-24 to cross reference the planned improvement.

^b Dates provided are from the 2007 Madera County Regional Transportation Plan (RTP), which was used to determine projects used in transportation analysis. An updated 2011 Madera County RTP shows these projects have been delayed indefinitely and may or may not occur within the current planning horizon.

^c Dates provided are from 2007 Madera County Regional Transportation Plan (RTP), which was used to determine projects used in transportation analysis. An updated 2011 Madera County RTP shows these projects have moved up and will be completed in the next 5 years.

Table 2-8
 No Project Alternative – Planned Highway Improvements in Fresno

Location/Map No. ^a	Routes	Planned Improvements	Project Timeline
21	SR 145	Widen to four lanes between SR 99 and Yosemite Avenue	Unidentified timeline
22	Interchange SR 99 at proposed Veterans Boulevard	Construct new interchange and rail crossings and new Veterans Boulevard extension from Shaw to Herndon	Open to traffic 2020
23	Interchange SR 99 at Grantland Avenue	Improve interchange	Open to traffic 2016

Location/Map No. ^a	Routes	Planned Improvements	Project Timeline
24	SR 99	Widen to eight lanes with auxiliary lanes (2 phases) between Clinton Avenue and Ashlan Avenue	Estimated completion 2025
25	SR 41	Southbound auxiliary lane between El Paso Avenue and Friant Road	Open to traffic 2017
26	SR 41	Northbound auxiliary lane between Bullard Avenue and Herndon Avenue	Open to traffic 2012
27	Interchange SR 99 at Shaw Avenue	Improve interchange	Open to traffic 2035
28	SR 41	Northbound auxiliary lane between Ashlan Avenue and Shaw Avenue	Open to traffic 2035
29	SR 41	Auxiliary lanes between O Street and Shaw Avenue	Open to traffic 2035 ^b
30	SR 41	Widen interchange ramps between McKinley Avenue and Shields Avenue	Open to traffic 2011
31	SR 180	Construct braided ramp between SR 41 and SR 168	Open to traffic 2014
32	SR 99	Update closed bridge structure	Open to traffic 2012
33	SR 99	Widen to six lanes between Ashlan Ave and Madera County line	Open to traffic 2016 ^b

^a See Figure 2-25 to cross reference the planned improvement.

^b Dates provided are from 2007 Fresno County Regional Transportation Plan (RTP), which was used to determine projects used in transportation analysis. Project limits have been adjusted in 2011 Regional Transportation Plan and full project may not be constructed in this timeframe.

Several of the roadway improvements are directly related to Caltrans' plans for the improvement of SR 99, the primary north-south highway in the corridor and a major state priority. The updated *Route 99 Corridor Business Plan* (Caltrans 2009b) incorporates these efforts and provides the current blueprint for the corridor. That plan defines the improvements necessary to attain the primary objective of a minimum six-lane freeway for the entire corridor. The four priority categories for improvements in the plan and their relationship to the Merced to Fresno Section include the following:

- Priority Category 1 (Freeway Conversion) – The new interchange projects at Plainsburg Road and Arboleda Road in Merced County will complete the conversion to a full freeway standard in this section.
- Priority Category 2 (Capacity-Increasing Projects) – Several projects will provide a minimum of 6 lanes in Merced and Madera and the urban portion in Fresno is planned for 8 to 10 lanes.
- Priority Category 3 (Major Operational Improvements) – Several interchanges are programmed for reconstruction and widening, including SR 233, SR 152, Avenue 17, Avenue 12, and Shaw Avenue.
- Priority Category 4 (New Interchanges) – New interchanges are planned at Ellis Street, Avenue 22, and Veterans Boulevard.

Outside of SR 99 plans, the planned highway improvements in the No Project Alternative will partially address the growth in travel but will not add substantial north-south intercity capacity to the system.

2.4.1.3 Aviation Element

Two commercial airports serve the communities in the Merced to Fresno Section—Fresno Yosemite International Airport and Merced Municipal/Macready Field. Additionally, several general aviation airports that only serve private small aircraft lie in the corridor; among them are Chowchilla Municipal and Madera Municipal. Table 2-9 provides a summary of the usage of the commercial airports in the last 10 years in terms of enplanements (or boarding passengers).

As Table 2-9 shows, there has been relatively little growth in passenger usage over 10 years and a slight decline over the past 5 years. Following Table 2-9 is a summary description of these airports, including a discussion of planned improvements and factors affecting future growth.

Table 2-9
 Passenger Boardings for Fresno and Merced Airports

Airport	2000	2005	2006	2007	2008	2009	Change 2000- 2009	Change 2005- 2009
Fresno	501,204	574,012	623,997	636,032	600,489	580,203	78,999	6,191
Merced	5,157	8,616	7,885	6,196	2,173	1,052	-4,105	-7,564
Total	506,361	582,628	631,882	642,228	602,662	581,255	74,894	-1,373

Source: FAA Annual Passenger Boarding Data (2010).

Fresno-Yosemite International Airport

Northeast of Fresno and east of SR 41, this municipally owned airport is the Valley’s major airport, serving a six-county region. Eight certified carriers provide nonstop service to nine domestic locations and also offer international direct service to Guadalajara, Mexico. The domestic service includes major hub airports in the west, including Denver, Phoenix, Seattle, and Las Vegas. Within California, direct service is provided to Los Angeles and San Francisco.

The airport terminal includes a recently remodeled lobby and a two-story concourse with six gates. The facility has two runways—a primary 9,227-foot commercial runway and a secondary shorter runway for smaller aircraft. Fresno Yosemite International Airport (FAT) served 600,489 passenger enplanements in 2008 and was projected to have 575,709 enplanements in 2010, similar to passenger usage over the past 5 years. Of these, 199,680 are estimated to be trips within the state of California that connect to San Francisco and Los Angeles International Airports. The in-state weekly capacity is currently about 750 seats.

Future improvement plans for FAT are documented in the 2006 Fresno Airport Master Plan (AMP). The AMP projects growth in airport usage, estimating 852,000 enplanements in 2025 (a 40% increase). Total aircraft operations are estimated to increase 20%. To meet this demand, the AMP identifies needed facility improvements. These include short-term (by 2014) projects such as lengthening and widening the secondary runway, rehabilitating and extending taxiways, and other site improvements. The AMP also includes longer-term (2015-2025) planned improvements such as additional taxiway rehabilitation and installation of an Instrument Landing System for the secondary runway.

As population within the six county service area increases, operations at FAT will increase. However, studies have shown that demand at FAT is suppressed due to market forces of air fares, the availability of automobile travel, and alternative airports in the Bay Area, Sacramento, and Los Angeles (Fresno County Council of Governments 2010). A significant number of potential passengers (possibly as high as 300,000 a year) who might use intrastate air service, if available and competitively priced, instead are making auto trips to their destination or to other state airports. These market forces will influence the growth in future operations at the airport.

Merced Municipal/Macready Field

The Merced Municipal Airport (MCE) is located southwest of Downtown Merced, south of SR 140. While service was briefly provided to Ontario Airport in California, on April 7, 2010, service returned to only two daily roundtrip flights to Las Vegas, where connections can be made to other destinations. Therefore, this airport is not currently serving intra-California destinations. Enplanements at MCE dropped substantially when service was changed from Las Vegas to Ontario. With the restoration of Las Vegas service, passenger usage is expected to return to 2007 levels.

Improvement plans for MCE are documented in the 2007 Merced Municipal Airport Master Plan and incorporated into the No Project Alternative. The plan forecasts (in 2026) a baseline increase in enplaning passengers to 53,000 annual passengers, with a low forecast of 14,800 passengers. The primary facility improvement recommended in the plan is a new 11,000-square-foot passenger terminal. This project is not currently funded.

2.4.1.4 Intercity Transit Element

Conventional Passenger Rail

Amtrak provides intercity conventional passenger rail service in California on four principal corridors covering more than 1,300 linear route miles and spanning almost the entire state. The No Project Alternative passenger rail element includes one of these corridors, the San Joaquin Route, which shares tracks with the BNSF freight line through the Merced to Fresno Section. Stations in Merced, Madera, and Fresno are located east of the downtown areas with limited intermodal connectivity at each station.

The San Joaquin Route currently provides four trips daily in each direction from Oakland to Bakersfield (with a bus connection to the Los Angeles Basin) and two trips daily in each direction from Sacramento to Bakersfield, for a total of six daily roundtrips serving Merced and Fresno. This route carried over 949,611 riders in fiscal year 2008 (Amtrak 2008) with an on-time performance of 87.9% (Amtrak 2010). The objective for the San Joaquin Route is to increase ridership from 853,000 in 2007-2008 to 1,417,000 in 2017-2018 (Caltrans 2008a). The current scheduled running time between Bakersfield and Oakland is 6 hours 9 minutes, at an average speed of 51.2 mph. The maximum speed on the route is 79 mph (Caltrans 2008b).

Intercity passenger rail system improvements identified in the State Transportation Implementation Program (STIP) and Caltrans' California State Rail Plan for implementation before 2020 are included in the No Project Alternative. Table 2-10 identifies these improvements. The improvements consist of additional track capacity, new rolling stock, grade-crossing improvements, track and signal improvements, and a new station in Madera.

Table 2-10
 Programmed Improvements in 2008 California State Rail Plan

Project Title	Project Description	Project Timeline
Merced Crossover	Construct crossover to increase efficiency	By 2017/18
Merced to Le Grand	Improvements to increase on-time performance and efficiency	Phase 1 - By 2012 Phase 2 - By 2015
Madera Station	Construct new station.	By 2017/18
Equipment	Purchase 2 trainsets (8 cars).	By 2017/18
Source: Caltrans (2008b).		

In addition to these programmed improvements, the State Rail Plan also identified additional capital improvements that are needed to support the planned service improvements. These currently unfunded improvements include track and signal projects to increase capacity in the Merced to Fresno segment. The plan also identifies the intent to develop options for originating some trains in Fresno and extending rail service from Bakersfield to Los Angeles.

In 2008, Caltrans, in partnership with the counties along the San Joaquin Route, completed the San Joaquin Corridor Strategic Plan. This study formalized the short-, medium- and long-term visions for the corridor and developed a preferred alternative and recommended improvement projects. The preferred plan provides a phased approach for service and capacity improvements. Many of the short- and mid-term improvements are included in the State Rail Plan. Longer-term improvements (25 years) include completing the double tracking of the corridor. The San Joaquin Corridor Strategic Plan and current State Rail Plan don't incorporate HST service, but it is anticipated that revised plans will be developed that address the changing role for the San Joaquin Route as a feeder service to HST System.

Intercity Passenger Bus Service

Regional bus service in the study area is provided by Greyhound-Trailways and Amtrak. Greyhound-Trailways Bus Lines provides scheduled bus service through the San Joaquin Valley along SR 99. Bus terminals are located in the cities of Merced and Fresno. Greyhound-Trailways also provides charter service to Yosemite Valley. Amtrak augments the San Joaquin trains with a system of buses that connect at the train stations. At Merced, Amtrak buses connect to Yosemite and Monterey destinations.

In the Merced area, additional regional bus service is provided by Yosemite Area Regional Transportation System (YARTS). YARTS provides bus service into Yosemite National Park with connections to intercity transportation providers in Merced such as Amtrak, Greyhound, and Great Lakes Airlines at the Merced Municipal Airport.

In the Fresno area, additional regional bus service is provided by Transportes InterCalifornias. This service provides daily roundtrips between Fresno and Los Angeles with connecting services to Santa Ana, San Ysidro, Tijuana, and Mexicali, and daily roundtrips to Stockton and San Jose. Service is provided to numerous intermediate points within the study area as well.

Greyhound provides daily service from Merced, Madera, and Fresno stations to destinations such as San Jose, San Francisco, Sacramento, Los Angeles, San Diego, and Las Vegas. Most of the northbound trips from Fresno run via the cities of Madera and Merced. Greyhound operates 5 daily trips to San Francisco (2 via Madera connecting San Jose and 3 via Madera and Merced), 4 daily trips to Sacramento (via Madera and Merced), and 10 daily trips to Los Angeles. Service to Las Vegas is provided via transfers at Bakersfield or Los Angeles.

While intercity bus service is likely to increase in the future, there are no documented plans for service expansion. Continued service is an element of the No Project Alternative, but only for a very small portion of the intercity travel market.

2.4.1.5 Freight Rail Element

Operating along the corridor's length, two Class I freight railroads (BNSF and UPRR) serve the Merced-Fresno corridor. The San Joaquin Valley lines for both BNSF and UPRR are important segments of their national rail systems. Freight rail traffic nationally has been growing, with a 31.4% increase in ton-miles of freight activity between 1997 and 2007 (Bureau of Transportation Statistics 2010).

Freight movements in the San Joaquin Valley are primarily interstate, since the railroads generally focus on shipments of 700 miles or more. For example, according to the 2009 Goods Movement Report for the Merced County Association of Governments, only 6% of agriculture goods in Merced County are moved by rail versus 94% by truck. While trucking is the dominant mode for moving freight (with rail only serving 11% of the total tonnage), the growth in roadway congestion is expected to increase the reliance on rail traffic, as noted in county plans including the Fresno County RTP.

The BNSF railroad alignment is generally located east of the SR 99 corridor. Top speed for freight operation is 65 mph. BNSF is also the primary owner of the railroad right-of-way used by the Amtrak San Joaquin Route. The average number of daily one-way train operations within the corridor is 20 to 24 daily train trips, of which 12 are Amtrak trains. The railroad owns a 276-mile section of the San Joaquin corridor from Bakersfield to Port Chicago, 6.5 miles east-northeast of Martinez in Contra Costa County. An increase in operations may constrain plans to increase Amtrak service, unless more of the corridor becomes double-tracked.

UPRR parallels SR 99 for most of the corridor. Top speed for freight operation is 70 mph. UPRR along this corridor is primarily single track. The average number of daily one-way train operations within the corridor is 20 to 24 daily train trips, per FRA Office of Safety (2010).

Both railroads are currently operating near capacity and, according to the 2009 Goods Movement Study Merced County Association of Governments 2009, will be above capacity by 2035. No formal capacity expansion plans are available for the freight corridors between Merced and Fresno. However, both railroads have historically added capacity when needed to meet market demand. These future improvements are expected to continue to provide sufficient capacity for interstate needs.

The BNSF will also gain capacity from planned improvements for the expansion of Amtrak San Joaquin service, as defined in the State Rail Plan. Additionally, BNSF will benefit from the grade separations currently programmed by the counties (see the Highway Element section above), such as the Atwater-Merced Expressway and the Shaw Avenue overcrossing in Fresno.

2.4.2 UPRR/SR 99 Alternative

This section provides a detailed description of the UPRR/SR 99 Alternative, including the Chowchilla design options. It also describes the Ave 24 Wye and Ave 21 Wye options, as well as the Downtown Merced and Downtown Fresno HST stations. Figures 2-27a through 2-27c show each of the UPRR/SR 99 north-south alignment, design option, and wye combinations from Merced to Fresno. The north-south alignment, design options, and operational facilities such as traction power substations, paralleling stations, and switching stations are identified and discussed from north to south. The design drawings showing track alignments, profiles, typical sections, construction use areas, and other preliminary design information are included as Volume III (Alignments and Other Plans) of the Project EIR/EIS, available on the Authority's website (www.cahighspeedrail.ca.gov) or upon request on CD.

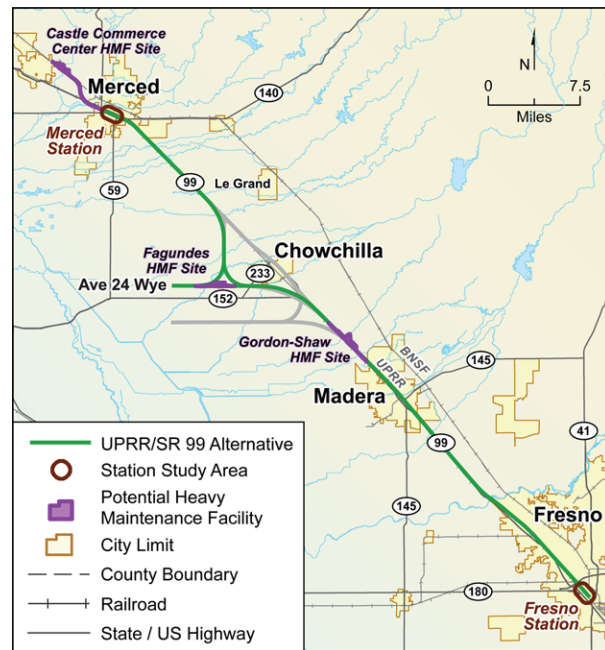

Figure 2-27a
 UPRR/SR 99 Alternative with West Chowchilla Design Option and Ave 24 Wye

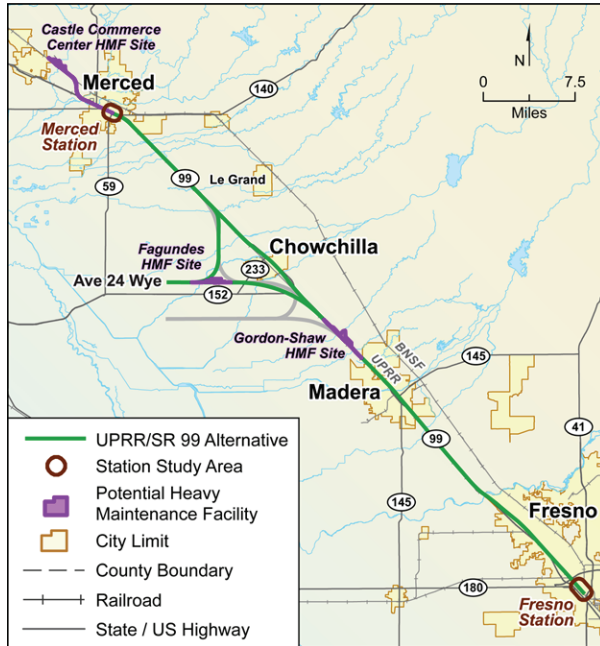

Figure 2-27b

UPRR/SR 99 Alternative with East Chowchilla Design Option and Ave 24 Wye

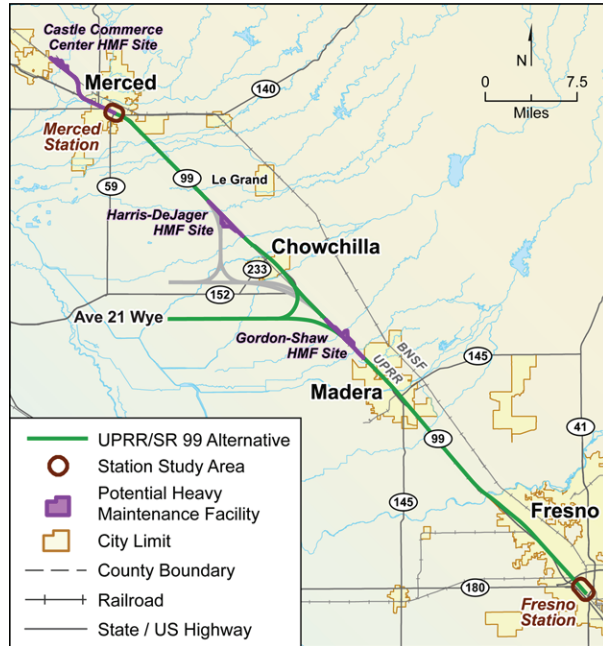

Figure 2-27c

UPRR/SR 99 Alternative with East Chowchilla Design Option and Ave 21 Wye

2.4.2.1 Alignment Requirements

The alignment for the UPRR/SR 99 Alternative traverses urban downtown areas in the cities of Merced, Madera, and Fresno. It is generally adjacent to SR 99 and UPRR. Some of the main features are shown in Figure 2-28 and described below.

- UPRR Adjacency:** The HST alignment is designed to follow the existing UPRR corridor adjacent to the UPRR mainline right-of-way. In several locations, the HST segment is elevated to cross over the UPRR operational right-of-way. In these instances, the alternative maintains required horizontal and vertical clearance over UPRR operational right-of-way to avoid or minimize impacts on other UPRR right-of-way, spurs, and facilities. The alternative is designed to avoid the existing UPRR operations right-of-way and active rail spurs to the greatest extent possible. Figure 2-29 shows cross section configurations, which provide for a 100-foot separation of the HST track centerline to the adjacent UPRR right-of-way boundary, with swale or berm protection or a wall when HST tracks are closer than that limit.
- SR 99 Adjacency:** Similarly, the HST follows the SR 99 corridor and, therefore, crosses over SR 99 in some locations and under SR 99 in Merced. In some instances, HST at-grade guideway may cross the roadway approaches of SR 99 overcrossings and interchange elements. As shown in Figure 2-28, the alignment could replace some major state facilities, overcrossings, and interchanges to avoid traffic impact during construction. (These project components are discussed in detail in Section 2.4.5, Modification of Caltrans/State Facilities).
- Frontage Road and Local Roadway Crossings:** As the alignment travels through rural regions, it affects existing local frontage roads used by small communities and farm operations. Where these frontage roads parallel the HST alignment, they would be shifted and reconstructed to maintain their function. Where roads are perpendicular to the proposed HST, over- or undercrossings are planned at approximately every 2 miles. In between, some roads may be closed. These are identified on project maps and a detailed list is provided in Appendix 2-A.

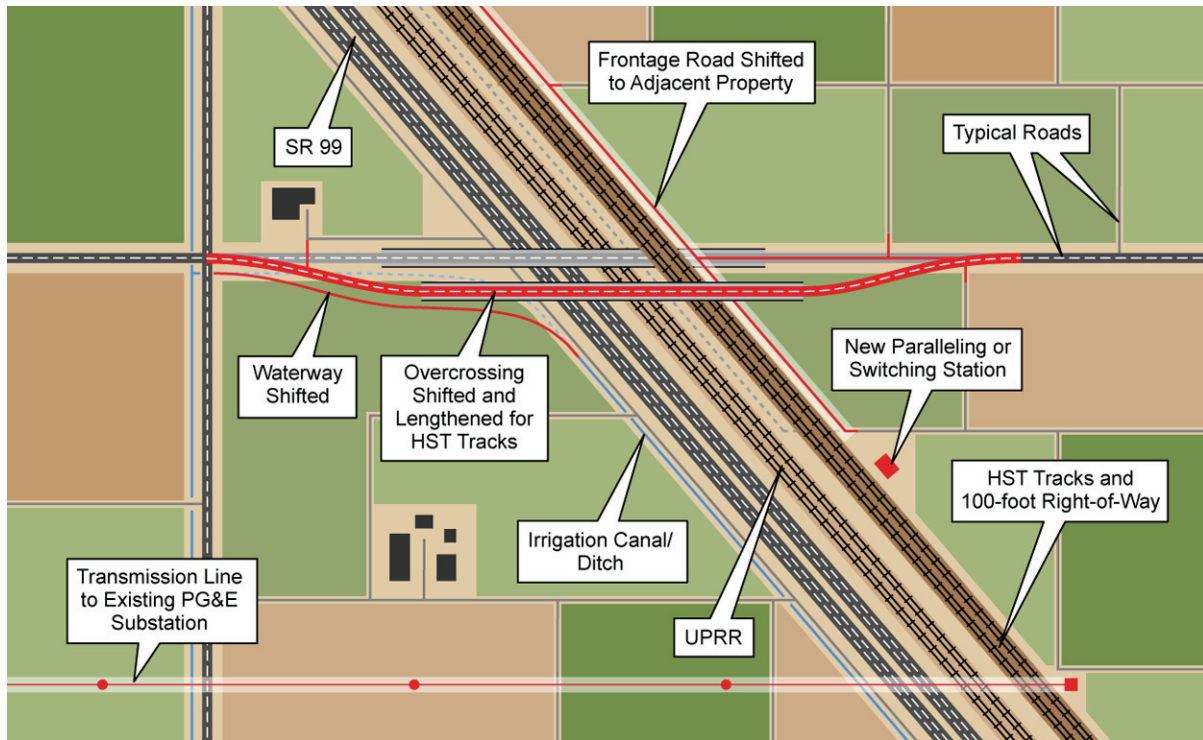

Figure 2-28
 UPRR/SR 99 Alternative Requirements

- **Irrigation and Drainage Facilities:** The HST alignment would affect existing drainage and irrigation facilities. Depending on the extent of the impact, existing facilities would be modified, improved, or replaced as needed to maintain existing drainage and irrigation functions and support HST drainage requirements.
- **Operational Facilities:** HST operational requirements include TPSSs, switching stations, paralleling stations, and underground or overhead power transmission lines. Working in coordination with power supply companies and per design requirements, the Authority and FRA have identified frequency and right-of-way requirements for these facilities.
- **Wildlife Crossing Structures:** Wildlife-designated crossings have been proposed to facilitate movement across the alignment by terrestrial wildlife species, including the San Joaquin kit fox.

The proposed design for wildlife-designated crossings consists of box culverts and free-standing bridges located below the tracks of the HST. The typical dimensions would be 73 feet long, 10 feet wide, and 3 feet high, resulting in an openness factor of 0.41 as measured by height \times width/distance (Bremner-Harrison et al. 2007). To accommodate variations in the topography, the height of the structure could extend as much as 18 inches below-grade; however, at least 50% of the vertical clearance would be above-grade. As a result, all terrestrial wildlife entering the crossing would be able to see light coming from the opposite end of the structure. To allow terrestrial wildlife unimpeded access to the crossing structures, right-of-way fencing would be diverted toward the toe of the slope, up the embankment, and above the entrance of the structure.

Where feasible from an engineering perspective, and appropriate from an ecological perspective, wildlife-designated crossings will be constructed with larger openings that would accommodate movement across the alignment by a wider range of terrestrial wildlife species. Depending on engineering constraints, the dimensions of these larger structures could reach as much as 6 feet high and 10 feet wide. The bottom of these larger structures would be approximately 12 inches above-grade and would not carry water during normal precipitation events.

Spacing and location of wildlife-designated crossings are proposed based on (1) existing land use, (2) existing and proposed infrastructure not associated with the HST Project, (3) previously identified wildlife movement corridors, and (4) consistency with ongoing efforts to recover listed species. Within the Eastman Lake-Bear Creek Essential Connectivity Area, wildlife-designated crossings would be spaced at approximately 0.3-mile intervals. Spacing would be at approximately 2.5-mile intervals where adjacent land uses are relatively conducive to wildlife movement (e.g., grazing land; grain, hay, idle pasture). Spacing intervals would not exceed one crossing for every 5 linear miles where adjacent land uses are not conducive to wildlife movement (e.g., vineyards, high-density development). Spacing and design of wildlife-designated crossings is subject to change and will be finalized in consultation with CDFG and USFWS.

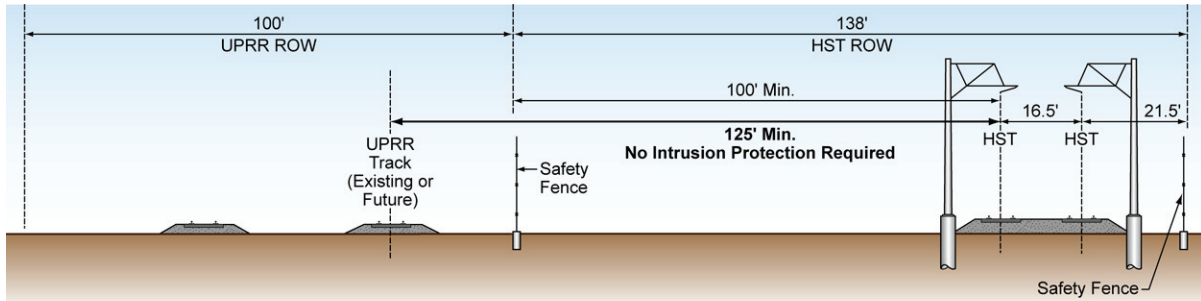

(a) UPRR/SR 99 Centerline-UPRR Right-of-Way Separation 100 Feet or More
 (No Intrusion Protection Required)

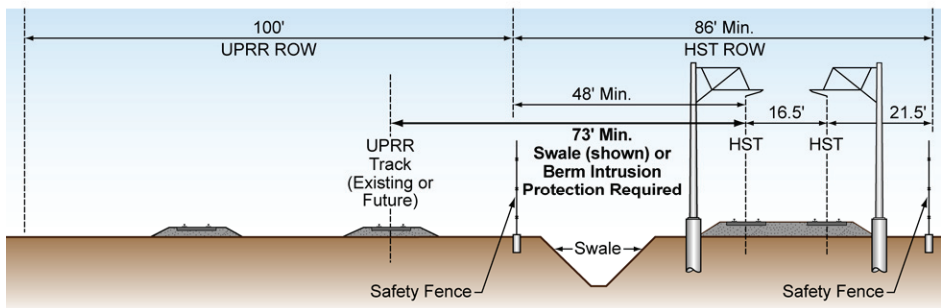

(b) UPRR/SR 99 Centerline-UPRR Right-of-Way Separation 48 Feet to 100 Feet
 (Swale or Berm Intrusion Protection Required)

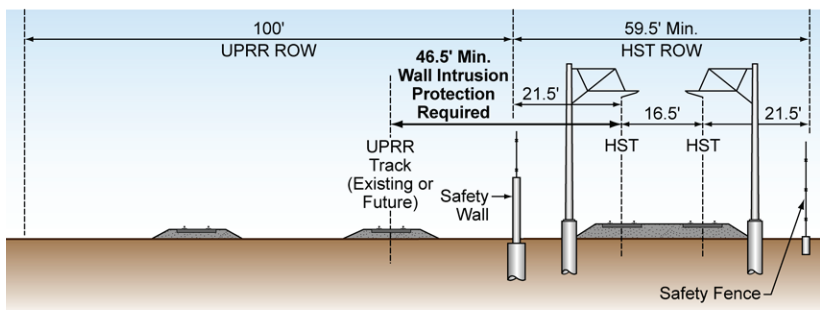

(c) UPRR/SR 99 Centerline-UPRR Right-of-Way Separation 21.5 Feet (Min.) to 48 Feet
 (Wall Intrusion Protection Required)

Figure 2-29
 UPRR/SR 99 Alternative – UPRR Right-of-way Cross Section Configurations

2.4.2.2 North-South Alignment

This section describes the UPRR/SR 99 Alternative as it traverses from north to south and crosses the Merced, Chowchilla, Madera, and Fresno vicinities. Appendix 2-A of this EIR/EIS provides additional detailed information of HST crossing public roadways within these vicinities.

Merced Vicinity (Merced Station to Deadman Creek)

The north-south alignment of the UPRR/SR 99 Alternative would begin at the HST station in Downtown Merced, located on the west side of the UPRR right-of-way (see Section 2.4.2.4 for Merced station options). South of the station and leaving Downtown Merced, the HST alignment would be at-grade and cross under SR 99.

Figure 2-30 shows the alignment through the Merced vicinity, including where the alignment would be at-grade. The figure also shows the locations of modified public roads and natural waterways that would be crossed by the HST. There are no design options in the Merced vicinity. The UPRR/SR 99 Alternative in combination with the Ave 24 Wye would have a TPSS in this vicinity that would connect to the existing PG&E Substation Wilson via an existing 115-kV overhead power line. The PG&E substation and overhead power line provide adequate power supply for the TPSS needs in this location.

Chowchilla Vicinity (Deadman Creek to Dry Creek)

Figure 2-31 shows the alignment and design options through the Chowchilla vicinity, including where the alignment would be at-grade and elevated. As the HST alignment approaches Chowchilla, the UPRR/SR 99 Alternative has two primary design options: the East Chowchilla design option, which would pass Chowchilla on the east side of town, and the West Chowchilla design option, which would travel south at a distance of 3 to 4 miles west of Chowchilla before turning back to rejoin the UPRR/SR 99 transportation corridor. The two design options are described as follows:

- The East Chowchilla design option would transition from the west side of UPRR/SR 99 to an elevated structure as it crosses UPRR and North Chowchilla Boulevard just north of Avenue 27, continuing on an elevated structure along the west side of and parallel to SR 99 away from the UPRR corridor while it crosses Berenda Slough. Toward the south side of Chowchilla, this option would cross over SR 99 north of the SR 99/SR 152 interchange near Avenue 23½ south of Chowchilla. Continuing south on the east side of SR 99 and the UPRR corridor, the alignment would remain elevated for 7.1 miles through the communities of Fairmead and Berenda, until reaching the Dry Creek crossing.
- The West Chowchilla design option would travel due south from Sandy Mush Road north of Chowchilla, following the west side of Road 11¾ (where the HST would decrease to a design speed of 150 mph). The alignment would turn southeast back toward the UPRR/SR 99 corridor south of Chowchilla. This design option would work only with the Ave 24 Wye (described in Section 2.4.2.3). The West Chowchilla design option would cross over the UPRR and SR 99 south of the Fairmead city limits, near Avenue 21½, to again parallel the UPRR/SR 99 corridor. Most of the alignment would be at-grade, except where the HST tracks from two different directions would be grade-separated as they cross each other. Compared to the East Chowchilla design option, this design option would result in a net decrease of approximately 13 miles of track for the HST System and would remain outside of the limits of the City of Chowchilla.

As noted earlier, the UPRR/SR 99 Alternative's adjacency to UPRR tracks also means fairly parallel alignments, with small skew angles when crossing the UPRR. The UPRR/SR 99 Alternative, including its wye and Chowchilla design options, would have several such crossings. As discussed previously, to avoid impacting UPRR operation, a series of straddle bents (see Figure 2-9) would clear 100 feet of operational right-of-way for the UPRR. A steel superstructure is an option for this condition, because its lighter weight would allow for longer spans.

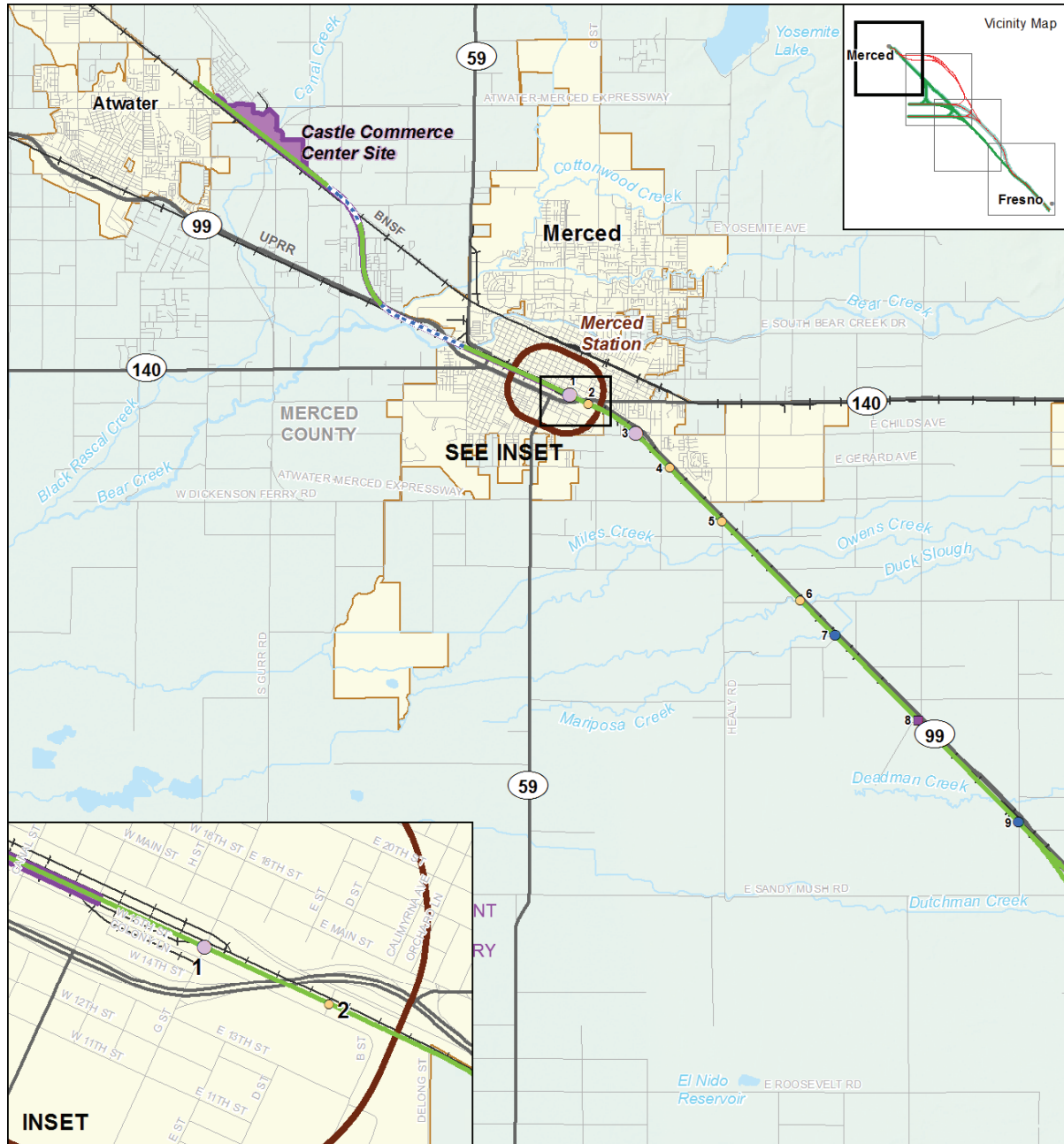

MF_EIS_PD_29_a Apr 05, 2012

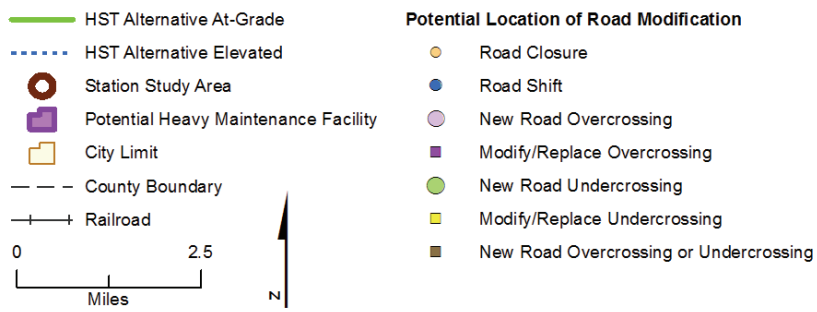
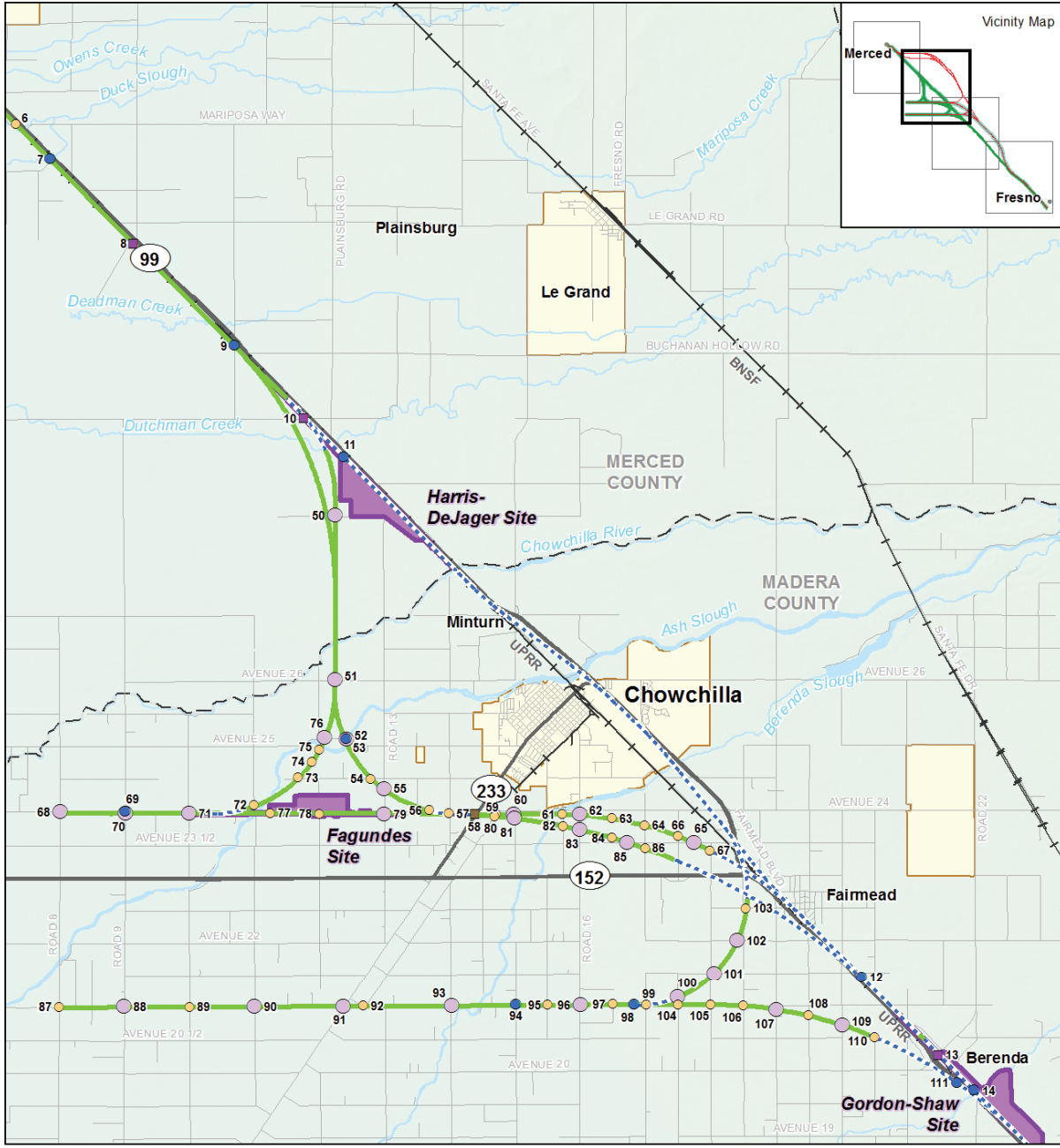

Figure 2-30
 UPRR/SR 99 Alternative in
 the Merced Project Vicinity



- | | |
|--|---|
| <ul style="list-style-type: none"> — HST Alternative At-Grade - - - HST Alternative Elevated Station Study Area Potential Heavy Maintenance Facility City Limit - - - County Boundary Railroad | <p>Potential Location of Road Modification</p> <ul style="list-style-type: none"> Road Closure Road Shift New Road Overcrossing Modify/Replace Overcrossing New Road Undercrossing Modify/Replace Undercrossing New Road Overcrossing or Undercrossing |
|--|---|

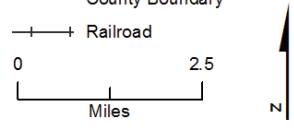

Figure 2-31
 UPRR/SR 99 Alternative in the Chowchilla Vicinity

Figure 2-31 shows the locations of public roads that would close or shift and natural watercourses that the HST would cross. The UPRR/SR 99 Alternative in combination with the Ave 21 Wye would have a TPSS in this vicinity that would connect to an existing PG&E substation on Porters Road near South Minturn Road via an existing overhead power line. The line would be upgraded to 115 kV for approximately 17,000 feet to provide adequate power supply for the TPSS needs in this location.

Madera Vicinity (Dry Creek to San Joaquin River)

Figure 2-32 shows the UPRR/SR 99 alignment and design options through the Madera vicinity, including where the alignment would be at-grade and elevated. The HST alignment would continue south on the east side of UPRR south of Dry Creek and remain on an elevated profile for 8.9 miles through Madera. After crossing over Cottonwood Creek and Avenue 12, the HST alignment would transition to an at-grade profile and continue to be at-grade until north of San Joaquin River. In the Madera vicinity, as discussed in more in detail in Section 2.4.5, the UPRR/SR 99 alternative would cross and affect SR 99 interchanges and overcrossings. Figure 2-32 also shows the locations of public roads that would be closed or shifted and waterways that would be crossed by the HST. There are no design options in the Madera vicinity.

The TPSS in this vicinity would connect to an existing PG&E substation on Avenue 12 via an existing overhead power line that passes near the TPSS site. The overhead line would be upgraded to 115 kV for approximately 9,300 linear feet, and new line would be provided for approximately 500 linear feet, to provide adequate power supply for the TPSS needs in this location.

Fresno Vicinity (San Joaquin River to Fresno Station)

Figure 2-33 shows the UPRR/SR 99 Alternative as it continues toward Fresno. The alternative would cross the San Joaquin River and rise over the UPRR railway on an elevated guideway supported by straddle bents; it would then cross over the existing Herndon Avenue and again descend into an at-grade profile. The alignment would continue west of and parallel to the UPRR right-of-way.

As shown in Figure 2-34a, after crossing the UPRR railway on the southern bank of the San Joaquin River, the HST alignment would require realignment (mostly a westward shift) of Golden State Boulevard to make room for the elevated HST structure right-of-way (approximately 50 feet). To the south of Herndon Avenue, the HST alignment would transition from the elevated profile to an at-grade profile, requiring a wider right-of-way (approximately 100 feet). Realignment of Golden State Boulevard and the at-grade HST profile would require modification of a future planned roadway extension project (Veterans Boulevard) and an existing local intersection (Shaw Avenue); these modifications have been and will continue to be closely coordinated with the City of Fresno public works, planning, and development agencies.

Traveling south from Golden State Boulevard (where, currently, both Ashlan Avenue and Clinton Avenue cross over the UPRR railway), an at-grade HST alignment, along with the UPRR railway, may be depressed a few feet below existing ground level to cross under the reconstructed Ashlan Avenue and Clinton Avenue overhead structures. Because the existing SR 99 is directly adjacent to the UPRR rail yard, the HST alignment would require a westerly realignment of SR 99 to make room for an at-grade HST right-of-way width of no less than 60 feet, as shown in Figure 2-34b. The realignment of SR 99 has been developed in close coordination with Caltrans and the City of Fresno.

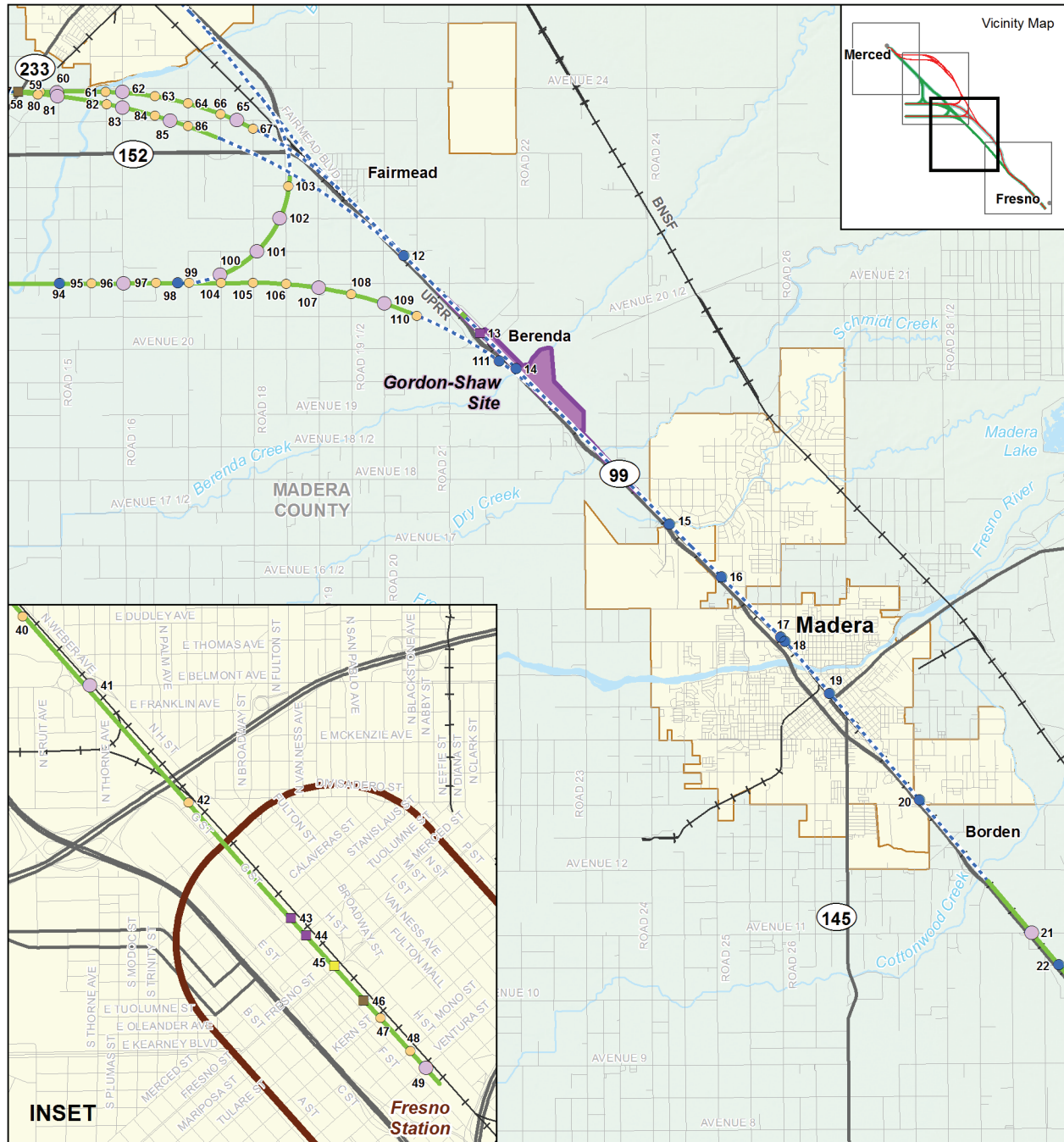

MF_EIS_PD_29_c Dec 14, 2011

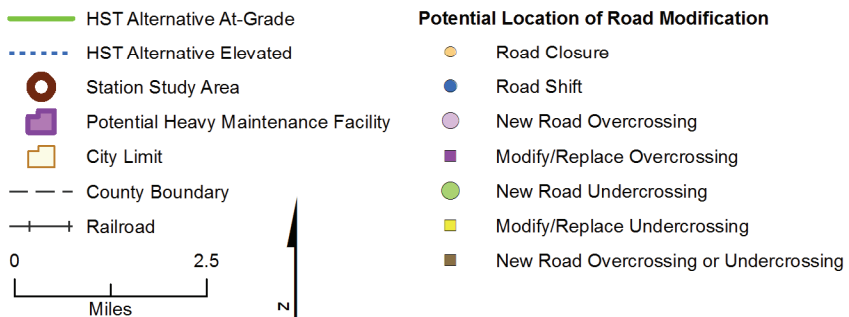
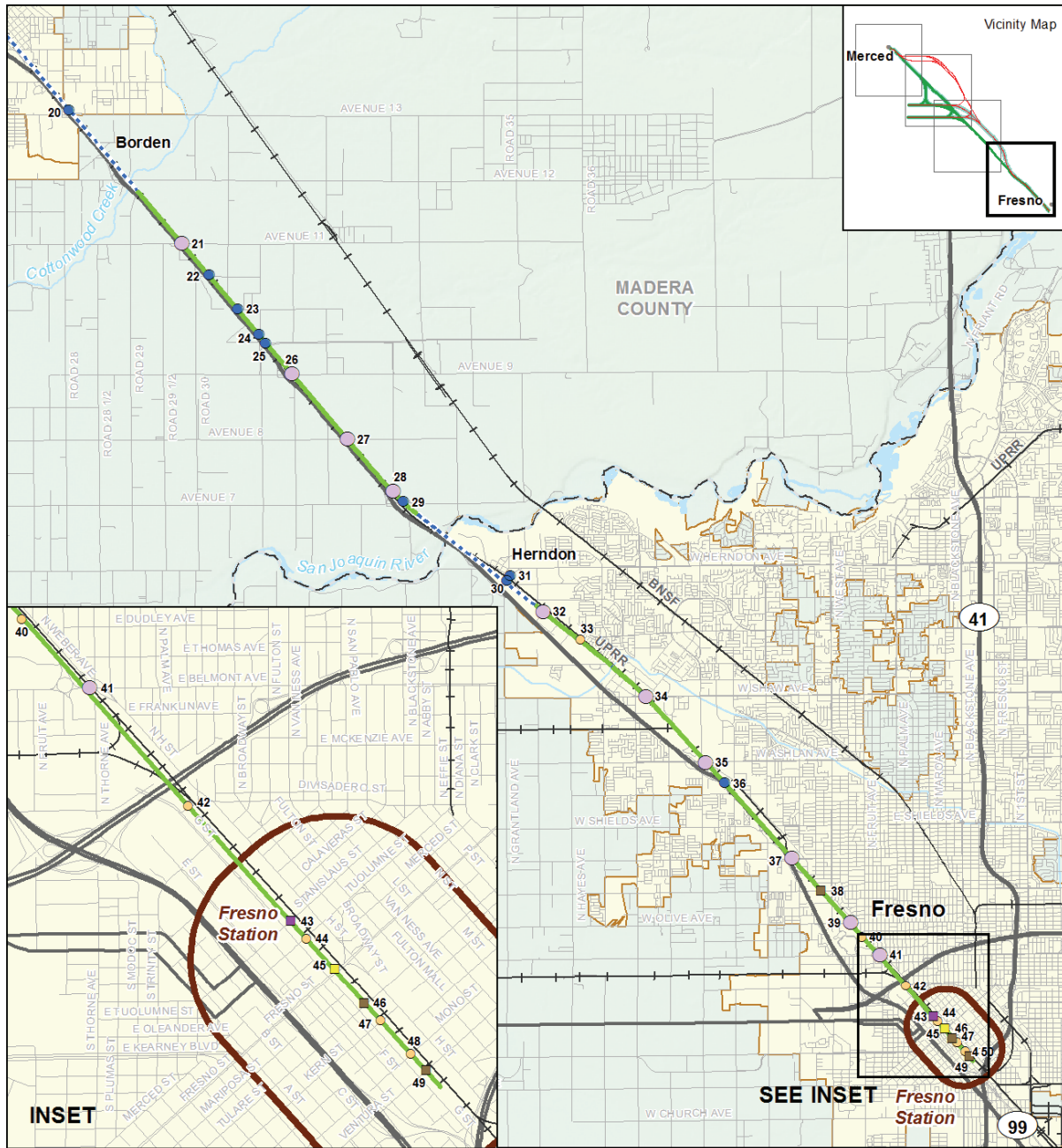

Figure 2-32
UPRR/SR 99 Alternative in
the Madera Vicinity



MF_EIS_PD_29_d Apr 05, 2012

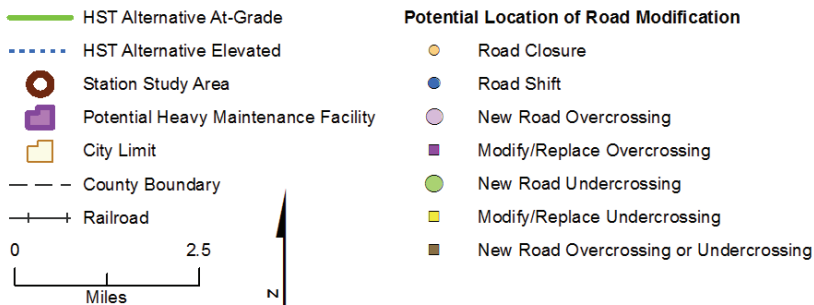

Figure 2-33
 UPRR/SR 99 Alternative in
 the Fresno Project Vicinity

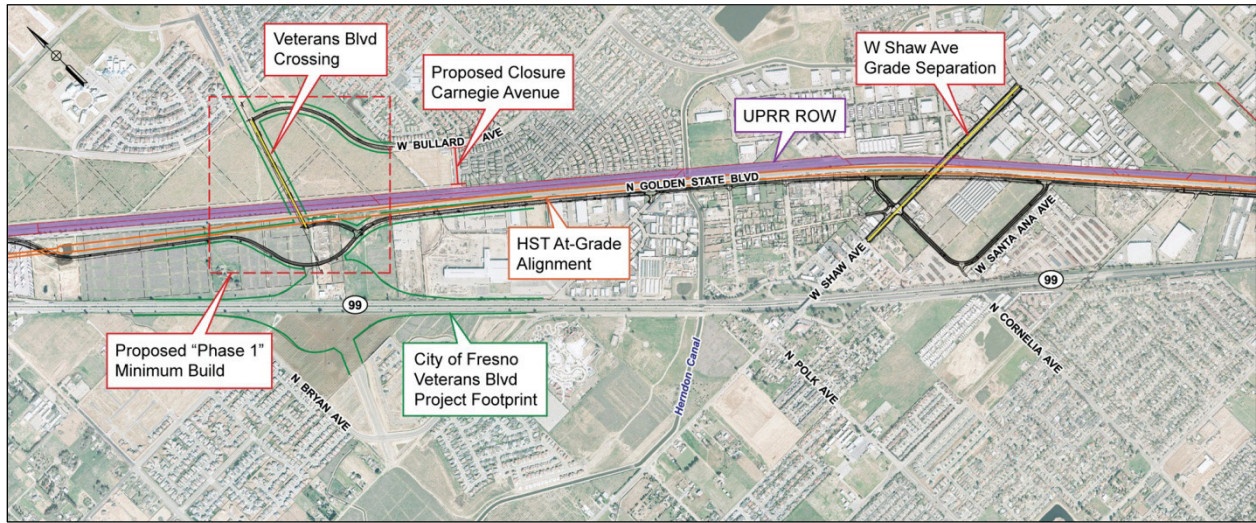

Figure 2-34a
Golden State Boulevard Realignment
(Between Veterans Boulevard and W Shaw Avenue)

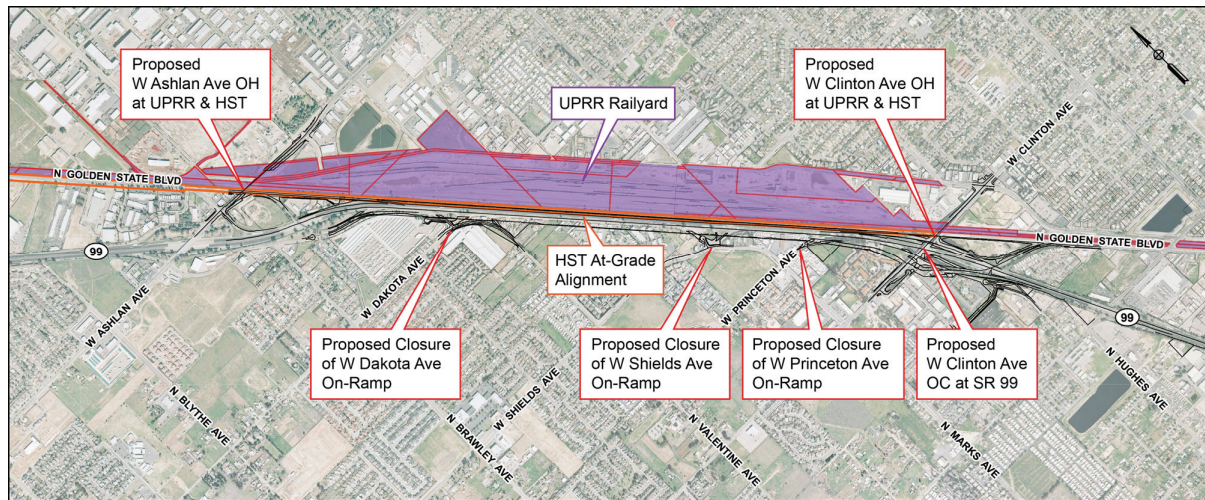
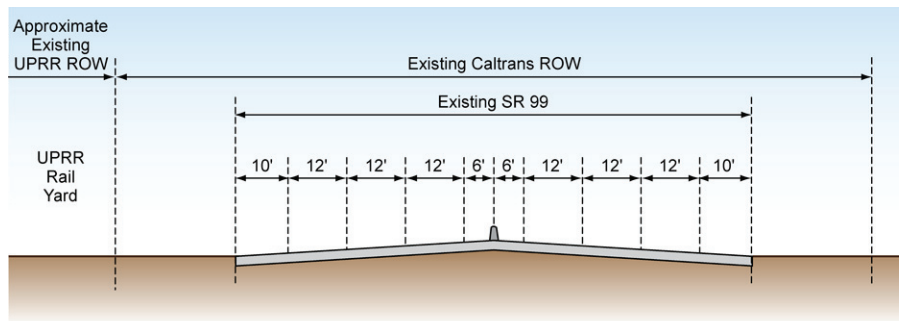

Figure 2-34b
SR 99 Realignment
(Between W Ashlan Avenue and W Clinton Avenue)

Realignment of SR 99 would take place before the at-grade HST construction begins. As shown in Figure 2-35, a typical section of the proposed SR 99 mainline would maintain six mixed-flow through lanes with the addition of one auxiliary lane in each direction between Clinton Avenue and Ashlan Avenue. Future project design would reconfigure the Clinton interchange to meet and maintain current Caltrans geometric standards. Realignment of SR 99 to the west would also affect several on- and off-ramps to and from SR 99 and intersections.

Advancing south from Clinton Avenue between Clinton Avenue and Belmont Avenue, the two-track HST alignment would run at-grade adjacent to the western boundary of the UPRR right-of-way and then enter the station. The alignment would again be depressed a few feet from approximately 900 feet south of Olive Avenue and 700 feet north of Stanislaus Street to minimize reconstruction of overpasses.

Realignment of Golden State Boulevard would be required to make room for the HST at-grade alignment between Clinton Avenue and Olive Avenue. The HST Project necessitates closure of the portion of Golden State Boulevard fronting Roeding Park. The at-grade HST alignment would also require constructing roadway structures at McKinley Avenue, Olive Avenue, and Belmont Avenue to cross over the HST guideway. The HST guideway would descend in a retained cut to pass under San Joaquin Valley Railroad spur line and SR 180, transition back to at-grade before Stanislaus Street and continue to be at-grade into the station. As part of a station design option, Tulare Street would become either an overpass or undercrossing at the station. These changes have been and will continue to be coordinated with the City of Fresno. A shoofly (i.e., temporary rerouting of existing railroad tracks) would be required between Fresno Street and SR41.



(a) Existing UPRR Right-of-Way and SR 99

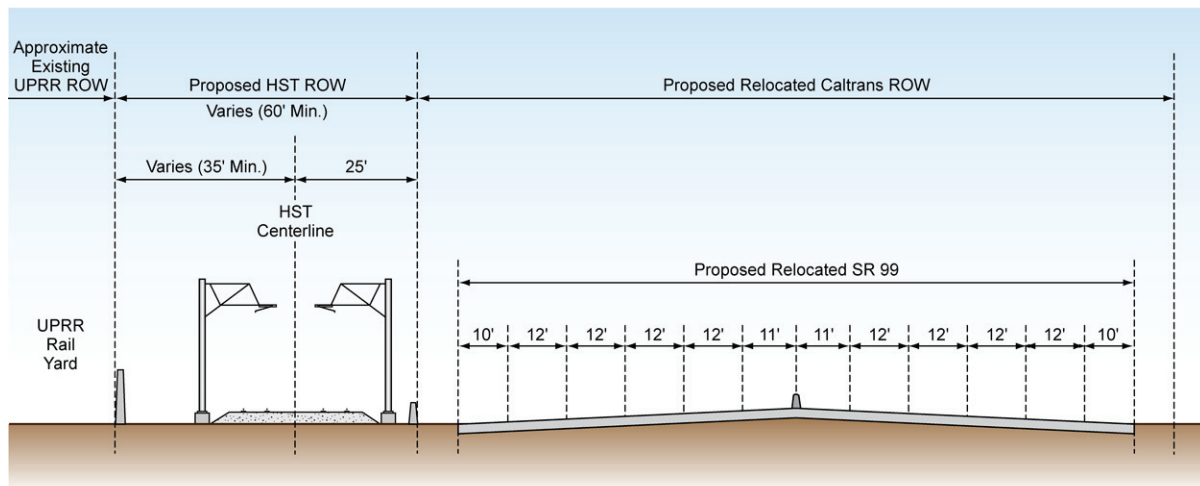

(b) Realigned UPRR Right-of-Way, HST, and SR 99

Figure 2-35
 Typical Cross Section of SR 99 Realignment

2.4.2.3 Wye Design Options

This section describes the wye connection from the San Jose to Merced Section to the Merced to Fresno Section. There are two variations of the Ave 24 Wye, and one Ave 21 option for the UPRR/SR 99 Alternative. Because of engineering constraints, the join points with the north-south alignment of the UPRR/SR 99 Alternative are not identical for the Ave 24 Wye and Ave 21 Wye.

Ave 24 Wye

The Ave 24 Wye, as illustrated in Figure 2-36a and 2-36b, would follow along the south side of Avenue 24 eastbound toward the UPRR/SR 99 Alternative and would begin diverging onto two sets of tracks beginning west of Road 11 and west of Chowchilla. Under the East Chowchilla design option, the northbound set of tracks would travel northeast across Road 12, joining the UPRR/SR 99 north-south alignment on the west side of the UPRR right-of-way just north of Sandy Mush Road. Under the West Chowchilla design option, the northbound set of tracks would travel northeast across Road 12 and would join the UPRR/SR 99 north-south alignment just south of Avenue 26. The southbound HST tracks would continue east along Avenue 24. Under the East Chowchilla design option, the southbound tracks would turn south near SR 233 southeast of Chowchilla, crossing SR 99 and the UPRR to connect to the UPRR/SR 99 north-south alignment on the east side of the UPRR near Avenue 21½. Under the West Chowchilla design option, the southbound tracks would turn south near Road 16 south of Chowchilla, crossing SR 99 and the UPRR to connect to the UPRR/SR 99 north-south alignment on the east side of the UPRR adjacent to the city limits of Fairmead. The crossing of SR 233 could be over or under the HST tracks.

Figure 2-36b highlights the difference in the wye triangle formation caused by the West Chowchilla design option, compared to the East Chowchilla design option shown in Figure 2-36a. The north-south alignment of the West Chowchilla design option between Merced and Fresno diverges along Avenue 24 onto Road 12, on the north branch of the wye. This option would avoid traveling through Chowchilla and would not constrain the city with the wye triangle.

Ave 21 Wye

The Ave 21 Wye, illustrated in Figure 2-37, would travel along the north side of Avenue 21. The tracks diverge north and south to connect to the UPRR/SR 99 Alternative just west of Road 16, with the north leg joining the north-south alignment at Avenue 23½ and the south leg at Avenue 19½. Figure 2-30 illustrates the locations of public road closures and shifts caused by the Ave 24 and Ave 21 wyes.

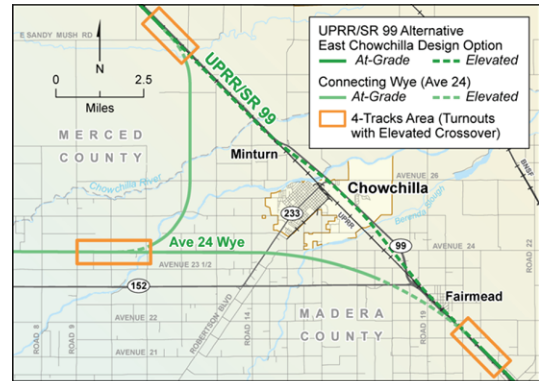

(a) Ave 24 Wye with the East Chowchilla Design Option

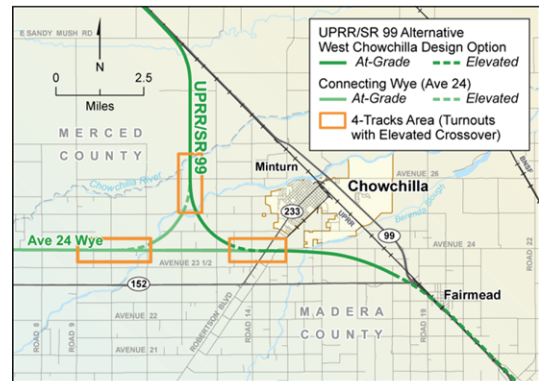

(b) Ave 24 Wye with the West Chowchilla Design Option

Figure 2-36a and b
 Ave 24 Wye and Chowchilla Design Options

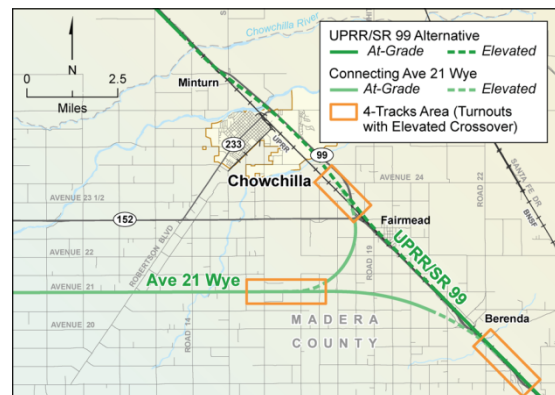

Figure 2-37
 Ave 21 Wye

While some discussions with the County of Madera have raised the possibility of relinquishing Avenue 21 to the HST Project to help minimize impacts on adjacent farmlands, at this time the design of the Ave 21 Wye remains positioned north of the Avenue 21 right-of-way to account for full potential impacts.

The Ave 21 Wye, in its current design geometry, has been refined to avoid and/or minimize impacts on the following nearby existing facilities:

- Chowchilla Airport
- Fairmead landfill and local museum
- Avenue 21½/SR 99 interchange

2.4.2.4 HST Stations

The Downtown Merced and Fresno station areas would each occupy several blocks, to include the station plazas, drop-offs, multimodal transit center, and parking structures. The areas would include the station platform and associated building and access structure, as well as lengths of platform tracks to accommodate local and express service at the stations. As currently proposed, both the Merced and Fresno stations would be at-grade, including all trackway and platforms, passenger services and concessions, and back-of-house functions. Table 2-11 summarizes the planning and design assumptions for the station throughout the implementation of the HST system in phases, where completion is 2020 for Phase 1 and 2027 for Phase 2, with a planning horizon of 2035. Table 2-11 reflects a ridership forecast under the *high* scenario (ticket price at 50% of airfare) (see Section 2.5, Travel Demand and Ridership Forecasts).

Table 2-11
 Planning and Design Assumptions

	Downtown Merced Station				Downtown Fresno Station			
	2020 ^a	2026 ^a	2027 ^b	2035 ^b	2020 ^b	2026 ^b	2027 ^b	2035 ^b
Average Weekday Boardings	2,500	6,800	2,000	2,600	2,700	7,500	7,600	8,400
Unconstrained Cumulative Parking Demand	2,500	6,900	1,600	2,100	2,400	6,600	6,700	7,400
Type of Station	Dual side platform with 4-track trackway							
Platform Length (station box)	1,410 feet							
Combined Width of Platform and Trackway (width of station box)	125 feet (160-foot minimum right-of-way)							
Storage Tracks	None				Intermediate station -- midday storage of one track in each direction of 1,300 feet beyond station			
^a Phase 1. ^b Full system.								

Downtown Merced Station (Preferred Alternative)

Depending on coordination with the City of Merced, the aesthetic features of the station house and station platforms may vary based on available funding opportunities. Figure 2-38a depicts a conceptual rendering of a potential “functional” station structure for Merced (compared to a potential “iconic” station shown in Figure 2-4); this rendering shows the architectural opportunities available for the station structure. It does not describe the actual station design that would eventually be built. This figure (and the cross section) also provides an understanding of the height and bulk of the facility. Collaboration with community members, agency, and stakeholder input will be key to determining the ultimate appearance of the station.

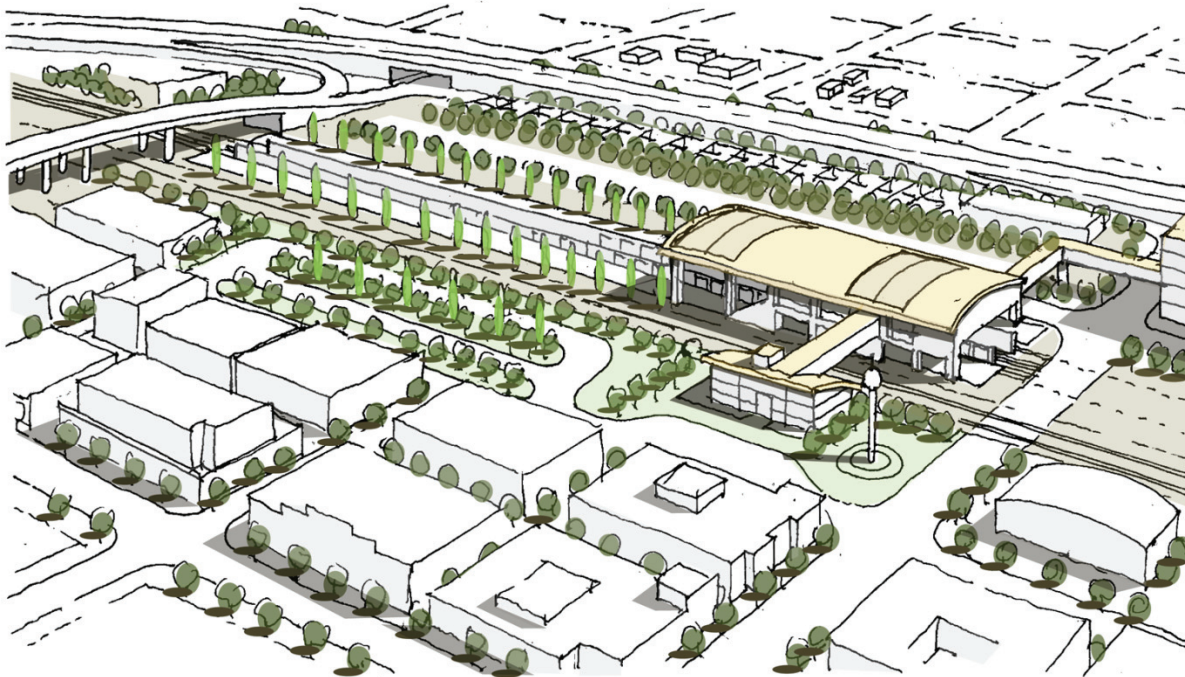

(a) Station Concept

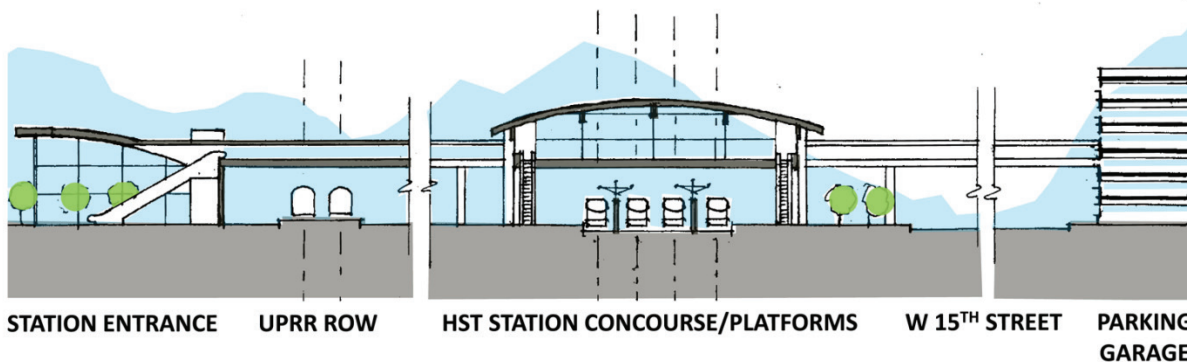

(b) Station Cross Section

Figure 2-38a and b
 Artist's Rendering and Cross Section of Functional Station Structure in Merced

The Downtown Merced Station would be between Martin Luther King Jr. Way to the northwest and G Street to the southeast, approximately 7 blocks west of the existing Amtrak station. The station would be accessible from both sides of the UPRR, but the primary station house would front 16th Street. The major access points from SR 99 include V Street, R Street, Martin Luther King Jr. Way, and G Street. Primary access to the parking facility would be from West 15th Street and West 14th Street, just one block east of SR 99. The closest access to the parking facility from the SR 99 freeway would be R Street, which has a full interchange with the freeway. The site proposal includes a parking structure that would have the potential for up to 6 levels with a capacity of approximately 2,250 cars and an approximate height of 50 feet. During Phase 1, when parking demand is higher at the station, additional parking would be provided at either distributed existing sites throughout the community or at a second structure on the surface parking site shown on Figure 2-39.

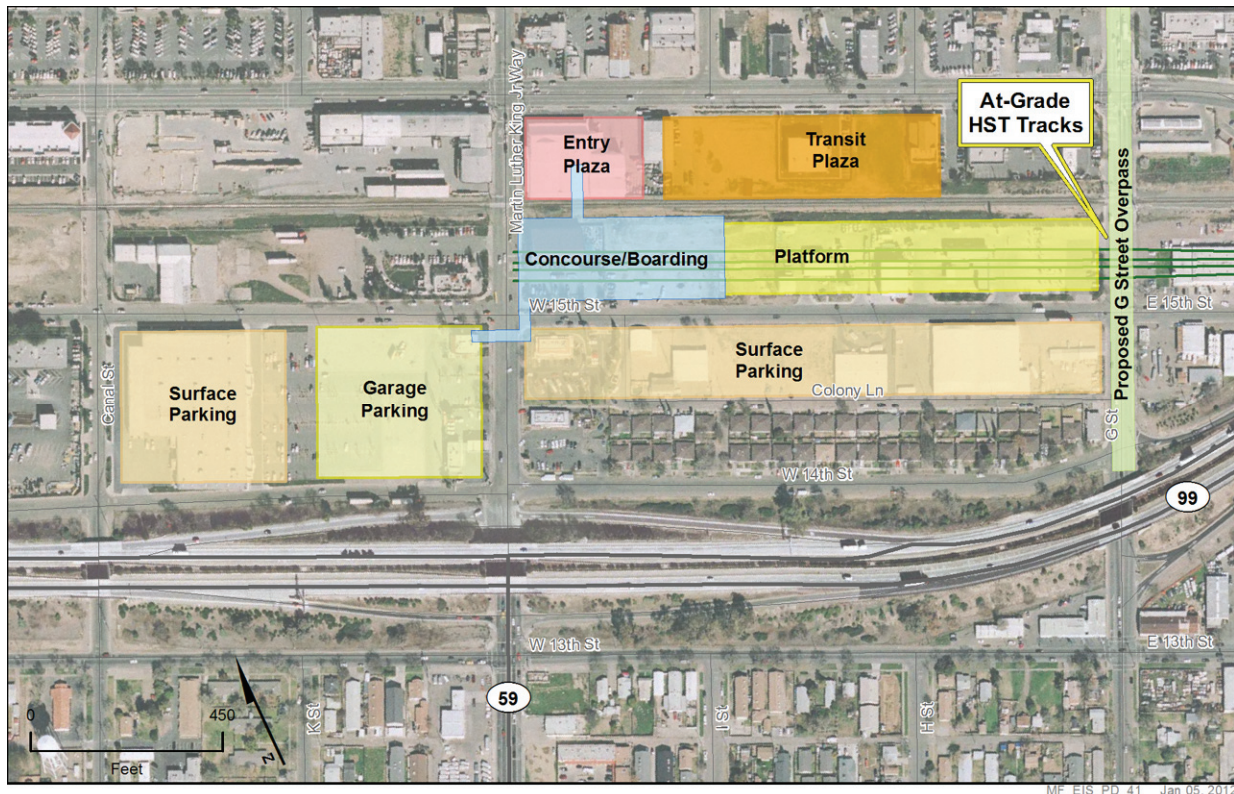

Figure 2-39
 Downtown Merced Station Location

The parking structure would be linked to the station box and station house by an elevated station access bridge. Patrons entering from the parking garage would connect to the station access bridge on the garage second level. The station could be connected to the current Downtown Intermodal Center via a shuttle bus.

Under Phase 1 of HST development, the station would serve as the terminus (end-of-line) station for an initial corridor extending from Los Angeles to Merced and San Francisco to the west. Under Phase 2, the Downtown Merced Station would become an intermediate (i.e., in-line) station on a corridor that would extend north to a terminus in Sacramento. Before completion of the corridor to Sacramento, the station would receive trains operating between Merced and San Francisco, as well as between Merced and points south in the Central Valley and Southern California. As a result, ridership and parking may be greater in the earlier terminus phase than later when service is provided north of Merced.

Downtown Fresno Station Alternatives

Two alternative sites are under consideration in Fresno: the Mariposa Street Station Alternative and the Kern Street Station Alternative. Figure 2-40 depicts conceptual station plans for the “functional” and “iconic” architectural design options for the Fresno station alternatives. The ultimate appearance of the station would be determined in collaboration with key community representatives and include stakeholder input.



a. Conceptual Station Design (Functional Design Treatment)



b. Conceptual Station Design (Iconic Design Treatment)

Figure 2-40
Conceptual Design for the Fresno Station

Source: VBN Architects, 2011

Mariposa Street Station Alternative (Preferred Alternative)

The Mariposa Street Station Alternative is located in Downtown Fresno, less than 0.5 mile east of SR 99. The station would be centered on Mariposa Street and bordered by Fresno Street on the north, Tulare Street on the south, H Street on the east, and G Street on the west. The area around the station contains a mixture of land uses, with industrial uses located along the UPRR corridor closest to the station and commercial, civic, and residential uses farther away from the rail corridor. Landmarks in the vicinity of the station include the Fulton Mall and Chukchansi Park to the east and Historic Chinatown to the west. A conceptual site plan of the Mariposa Street Station Alternative is provided in Figure 2-41.

The station building would be approximately 75,000 square feet, with a maximum height of approximately 64 feet. The two-level station would be at-grade; with passenger access provided both east and west of the HST guideway and the UPRR tracks, which would run parallel with one another adjacent to the station. The first level would contain the public concourse, passenger service areas, and station and operation offices. The second level would include the mezzanine, a pedestrian overcrossing above the HST guideway and the UPRR railway tracks, and an additional public concourse area. Entrances would be located at both G and H Streets. The eastern entrance would be at the intersection of H Street and Mariposa Street, with platform access provided via the pedestrian overcrossing. This entrance would provide a “front door” connection with Downtown Fresno on an axis that also includes the County Courthouse and City Hall several blocks to the east. The main western entrance would be located at G Street and Mariposa Street.

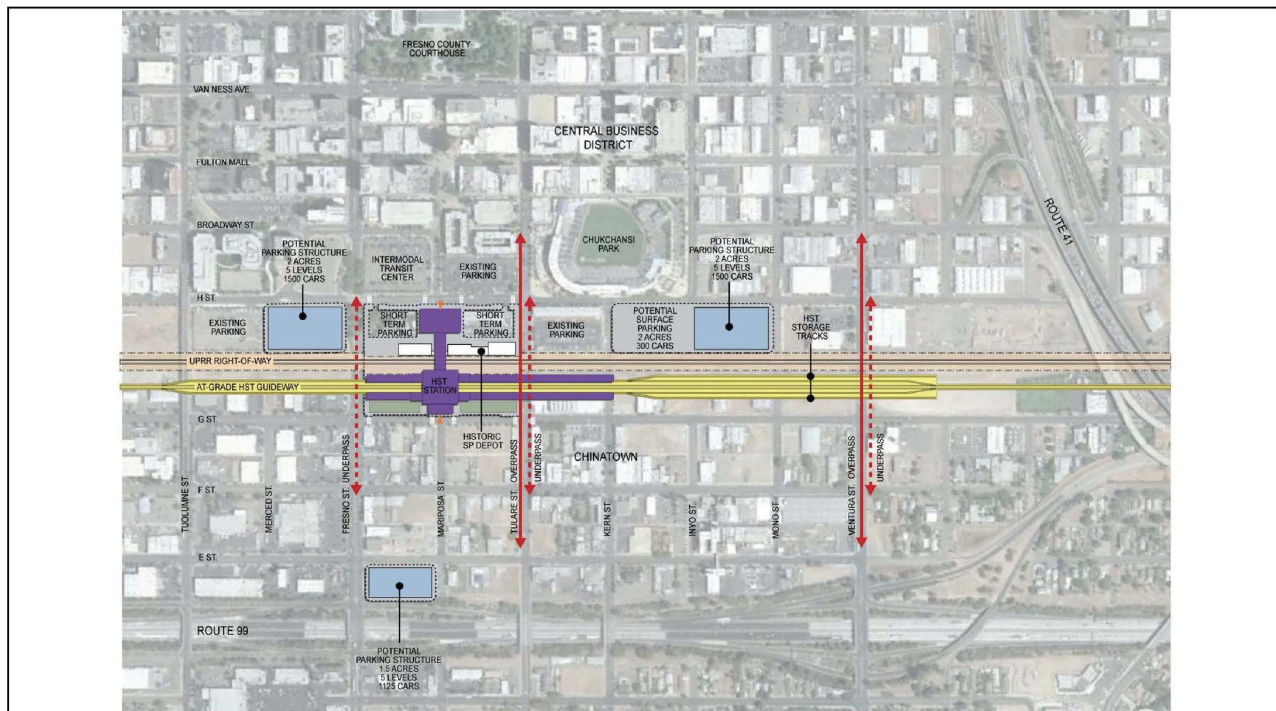

PRELIMINARY DRAFT/SUBJECT TO CHANGE - HST ALIGNMENT IS NOT DETERMINED

March 6, 2012

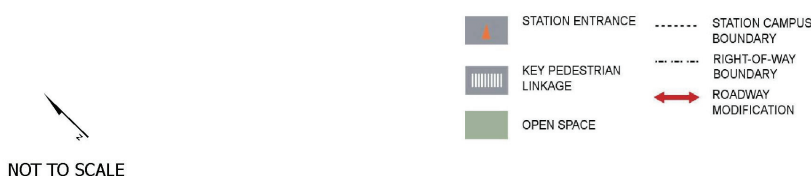

Figure 2-41
 Downtown Fresno Station –
 Mariposa Street Station Alternative

NOT TO SCALE

The majority of station facilities would be located east of the UPRR tracks. The station and associated facilities would occupy approximately 20.5 acres, including 13 acres dedicated to the station, short-term parking, and kiss-and-ride accommodations. A new intermodal facility, not a part of this proposed undertaking, would be located on the parcel bordered by Fresno Street to the north, Mariposa Street to the south, Broadway Street to the east, and H Street to the west (designated "Intermodal Transit Center" in Figure 2-41). Among other uses, the intermodal facility would accommodate the Greyhound facilities and services that would be relocated from their current location at the northwest corner of Tulare and H streets. The site proposal includes the potential for up to three parking structures occupying a total of 5.5 acres. Two of the three potential parking structures would each sit on 2 acres, and each would have a capacity of approximately 1,500 cars. The third parking structure would be slightly smaller in footprint (1.5 acres), with 5 levels and a capacity of approximately 1,100 cars. An additional 2-acre surface parking lot would provide approximately 300 parking spaces. Currently, Downtown Fresno has a large amount of excess public parking within a mile of the proposed HST station. Based on discussions with the City of Fresno, the balance of spaces needed to satisfy the estimated 2035 parking demand (7,400 total spaces) would be accommodated by existing public spaces, without the need for additional parking lots or structures. The Authority would work with the City of Fresno and other interested parties to phase parking supply to support HST ridership demand and the demand for emerging uses in the area surrounding the station.

Under this station alternative, the historic Southern Pacific Railroad depot and associated Pullman Sheds would remain intact. While these structures could be used for station-related purposes, they are not assumed to be functionally required for the HST Project and are thus not proposed to be physically altered as part of the project. The Mariposa station building footprint has been configured to preserve views of the historic railroad depot and associated sheds. Figures 2-42a and 2-42-b illustrate the relationship between the depot property and the proposed Mariposa Street Station Alternative.

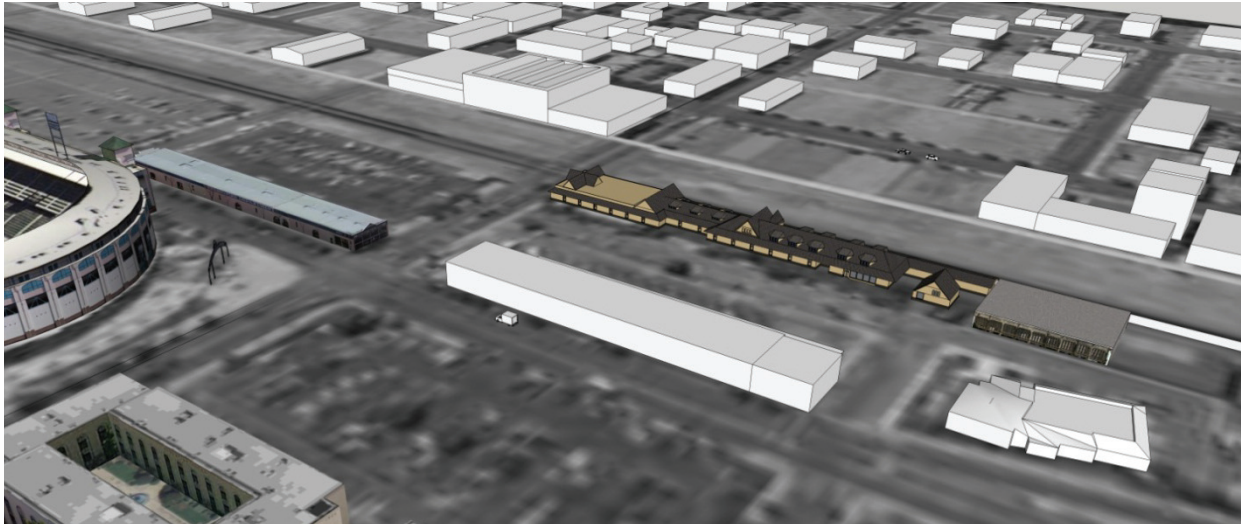

Figure 2-42a
South Facing Aerial View of Existing Southern Pacific Railroad Depot Property

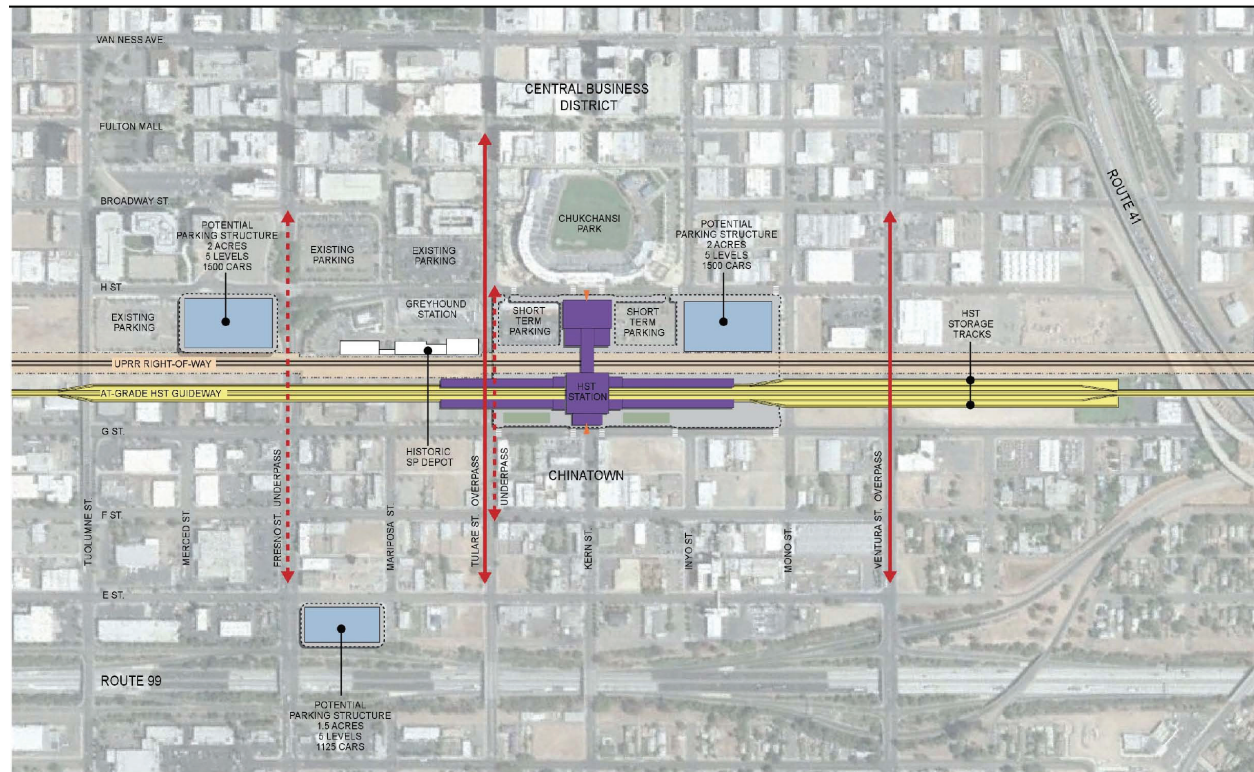

Figure 2-42b
South Facing Aerial View of Existing Southern Pacific Railroad Depot Property and Proposed Mariposa Street Station Alternative Area

Kern Street Station Alternative

The Kern Street Station Alternative for the HST station is also situated in Downtown Fresno and would be centered on Kern Street between Tulare Street and Inyo Street (Figure 2-43). This station would include the same components as the Mariposa Street Station Alternative, but under the Kern Street Station Alternative, the station would not encroach on the historic Southern Pacific Railroad depot just north of Tulare Street and would not require relocation of existing Greyhound facilities.

The station building would be approximately 75,000 square feet, with a maximum height of approximately 64 feet. The station building would have two levels housing the same facilities as the Mariposa Street Station Alternative (i.e., UPRR tracks, HST tracks, mezzanine, and station office).



Y DRAFT/SUBJECT TO CHANGE - HST ALIGNMENT IS NOT DETERMINED

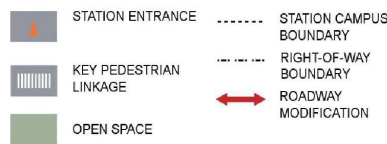

Figure 2-43
 Downtown Fresno Station –
 Kern Street Station Alternative

The approximately 18.5-acre site would include 13 acres dedicated to the station, bus transit center, short-term parking, and kiss-and-ride accommodations. Two of the 3 potential parking structures would each sit on 2 acres and each would have a capacity of approximately 1,500 cars. The third structure would be slightly smaller in footprint (1.5 acres) and have a capacity of approximately 1,100 cars. Like the Mariposa Street Station Alternative, the balance of the spaces needed to satisfy the estimated 2035 parking demand (7,400 total spaces) would be accommodated by existing public spaces, and the majority of station facilities would be sited east of the HST tracks.

2.4.3 BNSF Alternative

This section provides a detailed description of the BNSF Alternative, including the Mariposa Ave, Mission Ave, and Le Grand design options, including the Ave 24 and the Ave 21 wyes and the stations. The design drawings showing the track alignments, profiles, structures, typical sections, construction use area, and other preliminary design information are included as Volume III (Alignments and Other Plans) of the EIR/EIS, available on the Authority’s web site (www.cahighspeedrail.ca.gov) or upon request on CD. Figures 2-44a through 2-44h show each of the BNSF Alternative north-south alignment, design option, and wye combinations from Merced to Fresno.



Figure 2-44a

BNSF Alternative with Mission Ave and Le Grand Design Option and Ave 24 Wye

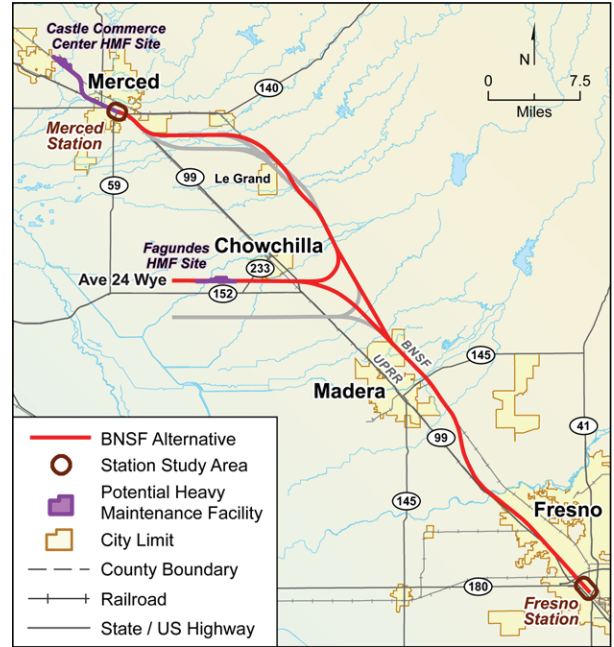

Figure 2-44b

BNSF Alternative with Mission Ave and East of Le Grand Design Option and Ave 24 Wye

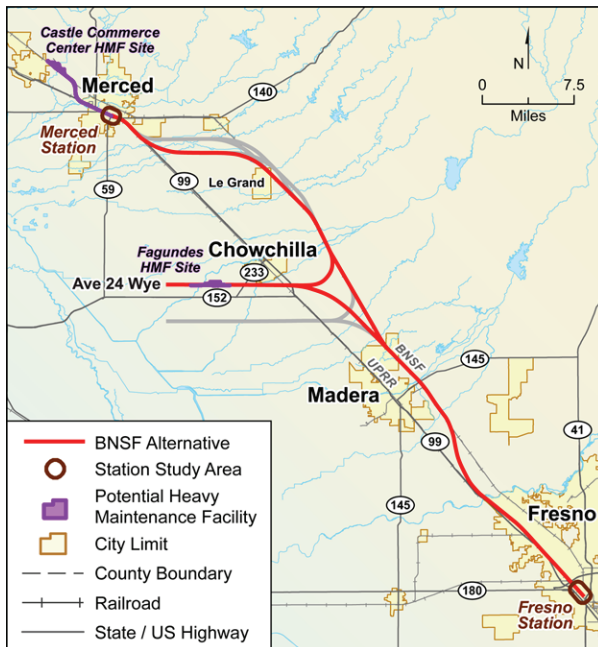

Figure 2-44c

BNSF Alternative with Mariposa Way and Le Grand Design Option and Ave 24 Wye

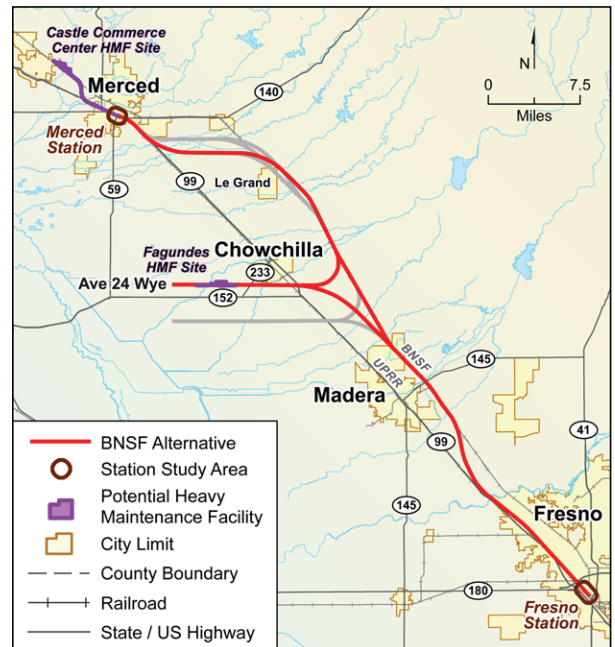

Figure 2-44d

BNSF Alternative with Mariposa Way and East of Le Grand Design Option and Ave 24 Wye

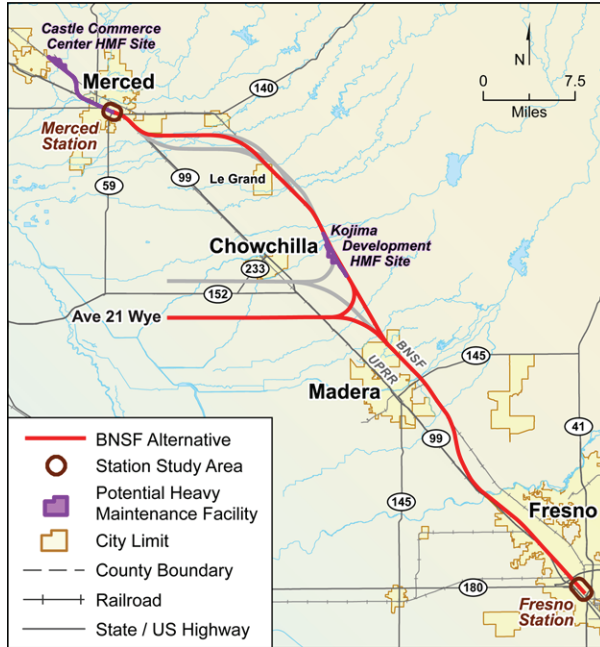

Figure 2-44e
 BNSF Alternative with Mission Ave and
 Le Grand Design Option and Ave 21 Wye

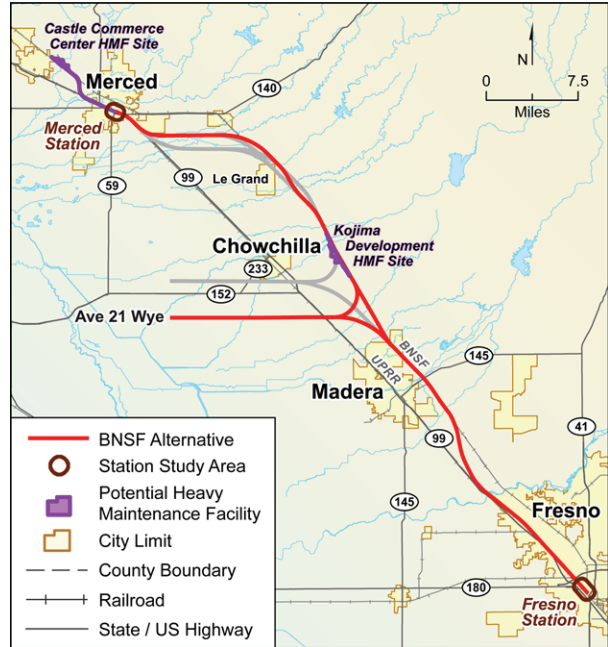

Figure 2-44f
 BNSF Alternative with Mission Ave and East of
 Le Grand Design Option and Ave 21 Wye

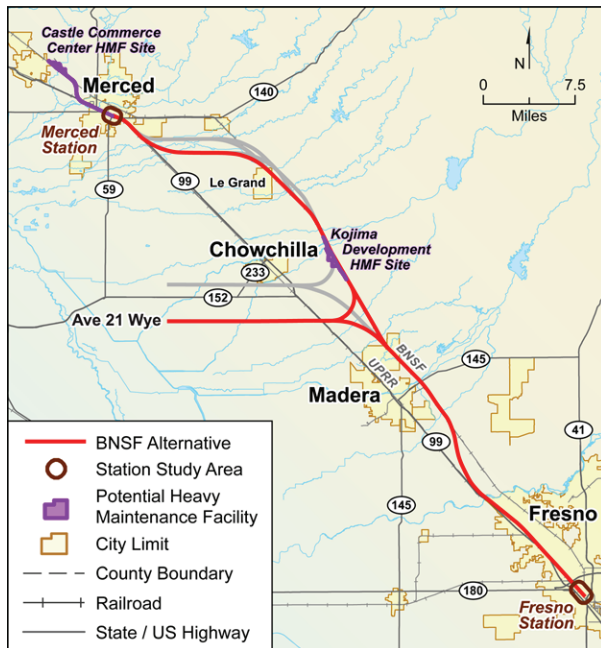

Figure 2-44g
 BNSF Alternative with Mariposa Way and
 Le Grand Design Option and Ave 21 Wye

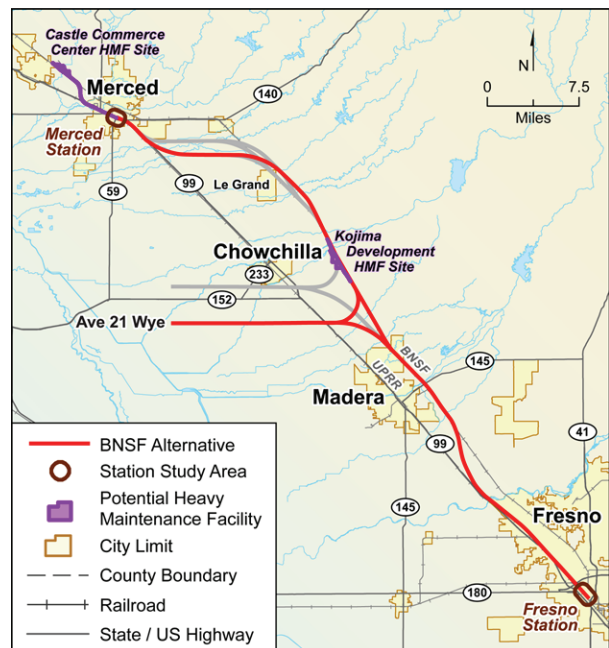
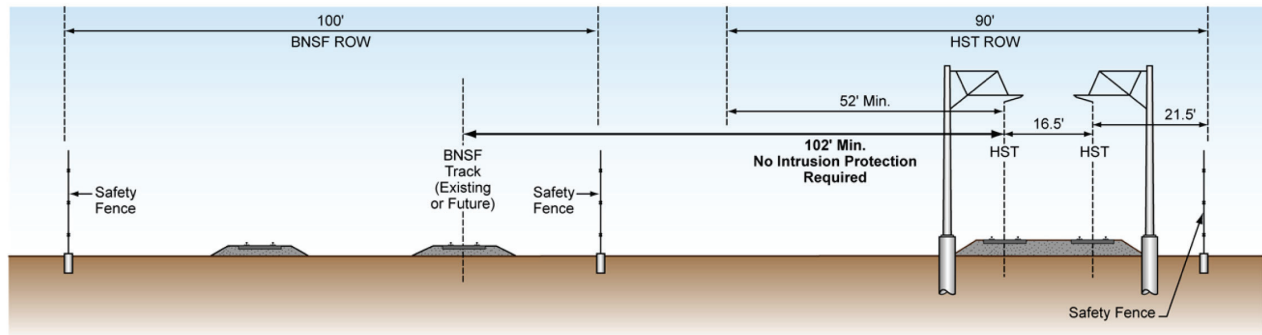

Figure 2-44h
 BNSF Alternative with Mariposa Way and East
 of Le Grand Design Option and Ave 21 Wye

2.4.3.1 BNSF Adjacency

As noted previously, an important objective of the project is to align HST tracks adjacent to existing corridors. The BNSF Alternative’s cross sections include provisions for a 102-foot separation of the HST track centerline from the BNSF track centerline, as well as separations that include swale or berm protection, or a wall when the HST tracks are closer.⁵ Figure 2-45 shows cross sections of these various configurations where there would not be a shared right-of-way with BNSF. Figure 2-46 shows the same cross sections where there is an opportunity to share right-of-way with BNSF; the design guidelines recognize BNSF as a potential shared corridor partner, which in some locations could reduce required horizontal separation of HST from the BNSF facility by as much as 25 feet, assuming the appropriate intrusion protection (barrier) is provided.



(a) BNSF Centerline Track-to-Track Separation 102 Feet or More
 (No Intrusion Protection Required)

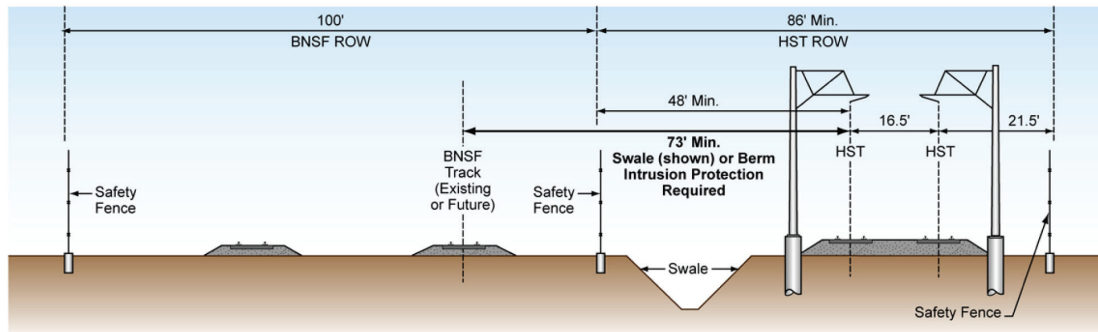

(b) BNSF Centerline Track-to-Track Separation 72 Feet to 102 Feet
 (Swale or Berm Intrusion Protection Required)

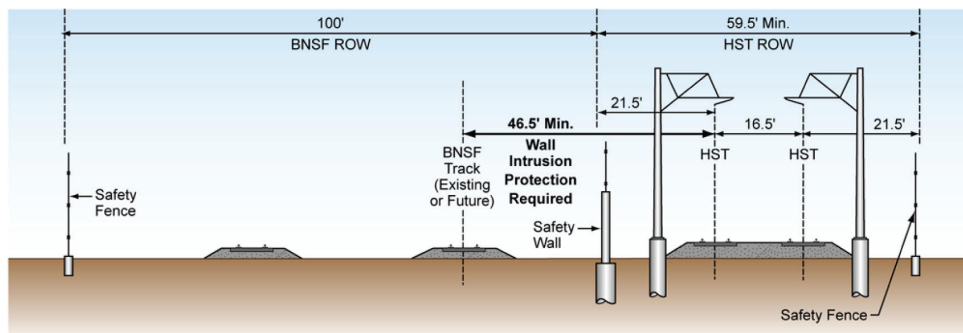

(c) BNSF Centerline Track-to-Track Separation 46.5 Feet (Min.) to 72 Feet
 (Wall Intrusion Protection Required)

Figure 2-45
 BNSF Alternative without Shared Right-of-Way

⁵ Due to right-of-way sharing agreements with BNSF, the HST right-of-way requirements adjacent to BNSF are narrower than that next to the UPRR/SR 99 Alternative.

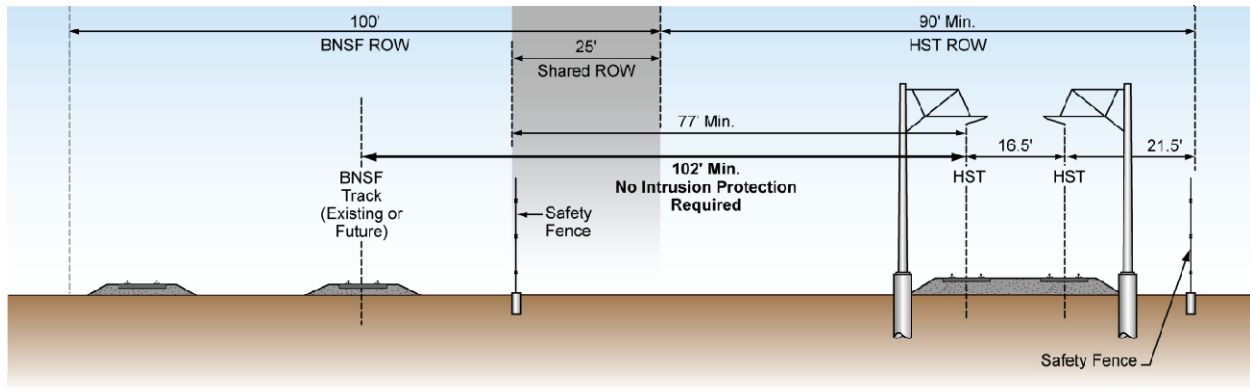

**(a) BNSF Centerline Track-to-Track Separation 102 Feet or More
 (No Intrusion Protection Required)**

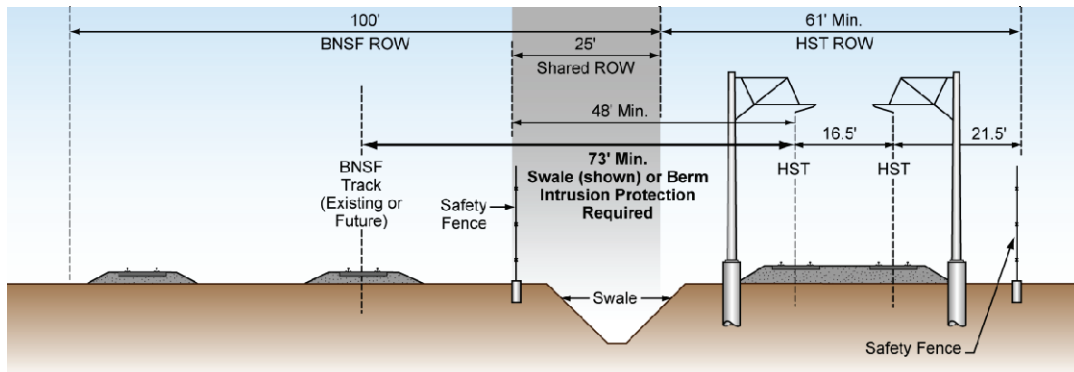

**(b) BNSF Centerline Track-to-Track Separation 72 Feet to 100 Feet
 (Swale or Berm Intrusion Protection Required)**

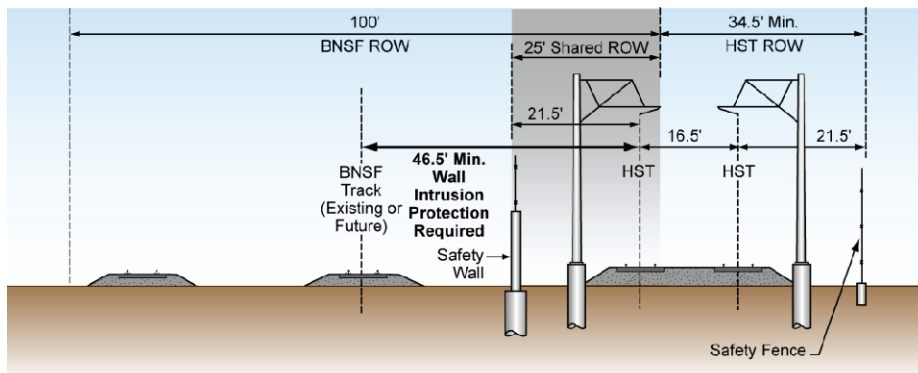

**(c) BNSF Centerline Track-to-Track Separation 46.5 Feet (Min.) 72 Feet
 (Wall Intrusion Protection Required)**

Figure 2-46
 BNSF Alternative Showing Opportunity for Shared Right-of-Way

2.4.3.2 North-South Alignment

This section provides a general description of the BNSF Alternative traversing from north to south, crossing the cities of Merced, Le Grand, Madera, and Fresno. Appendix 2-A provides additional detailed information about HST crossing roadways within these vicinities.

Merced Vicinity (Merced Station to Deadman Creek)

The north-south alignment of the BNSF Alternative would begin at the proposed at-grade HST station in Merced. This alternative would remain at-grade through Merced and would cross under SR 99 at the south end of the city. Just south of the SR 99/East Childs Avenue interchange, the BNSF Alternative would cross over SR 99 and UPRR once more as it begins to curve to the east, crossing over the E Mission Avenue interchange. It would then travel east to the vicinity of Le Grand where it would turn south and travel adjacent to the BNSF tracks. Figure 2-47 illustrates the BNSF Alternative near the City of Merced, as well as modifications to local public roads and waterways that the HST would cross.

To minimize impacts on the natural environment and the community of Le Grand, the project design includes four options that were developed in consultation with Merced County. These options are illustrated in Figure 2-48 and discussed below:

- **Mission Ave design option:** This design option would turn east to travel along the north side of Mission Avenue at Le Grand and then would elevate through Le Grand adjacent to and along the west side of the BNSF corridor.
- **Mission Ave East of Le Grand design option:** This design option would vary from the Mission Ave design option by traveling approximately 1 mile farther east before turning southeast to cross Santa Fe Avenue and the BNSF tracks south of Mission Avenue. The HST alignment would parallel the BNSF for one-half mile to the east, avoiding the developed area of Le Grand. This design option would cross Santa Fe Avenue and the BNSF railroad again approximately one-half mile north of Marguerite Road and would continue adjacent to the west side of the BNSF corridor.
- **Mariposa Way design option:** This design option would travel an additional mile (compared to the Mission Ave design option) before crossing SR 99 near Vassar Road and turning east toward Le Grand along the south side of Mariposa Way. East of Simonson Road, the HST alignment would turn to the southeast. Just prior to Savana Road in Le Grand, the HST alignment would transition from at-grade to elevated to pass through Le Grand on a 1.7-mile-long guideway adjacent to and along the west side of the BNSF corridor.
- **Mariposa Way East of Le Grand design option:** This design option would vary from the Mariposa Way design option by traveling approximately 1 mile farther east before turning southeast to cross Santa Fe Avenue and the BNSF tracks less than one-half mile south of Mariposa Way. The HST alignment would parallel the BNSF for one-half mile to the east, avoiding the developed area of Le Grand. This design option would cross Santa Fe Avenue and the BNSF again approximately one-half mile north of Marguerite Road and would continue adjacent to the west side of the BNSF corridor.

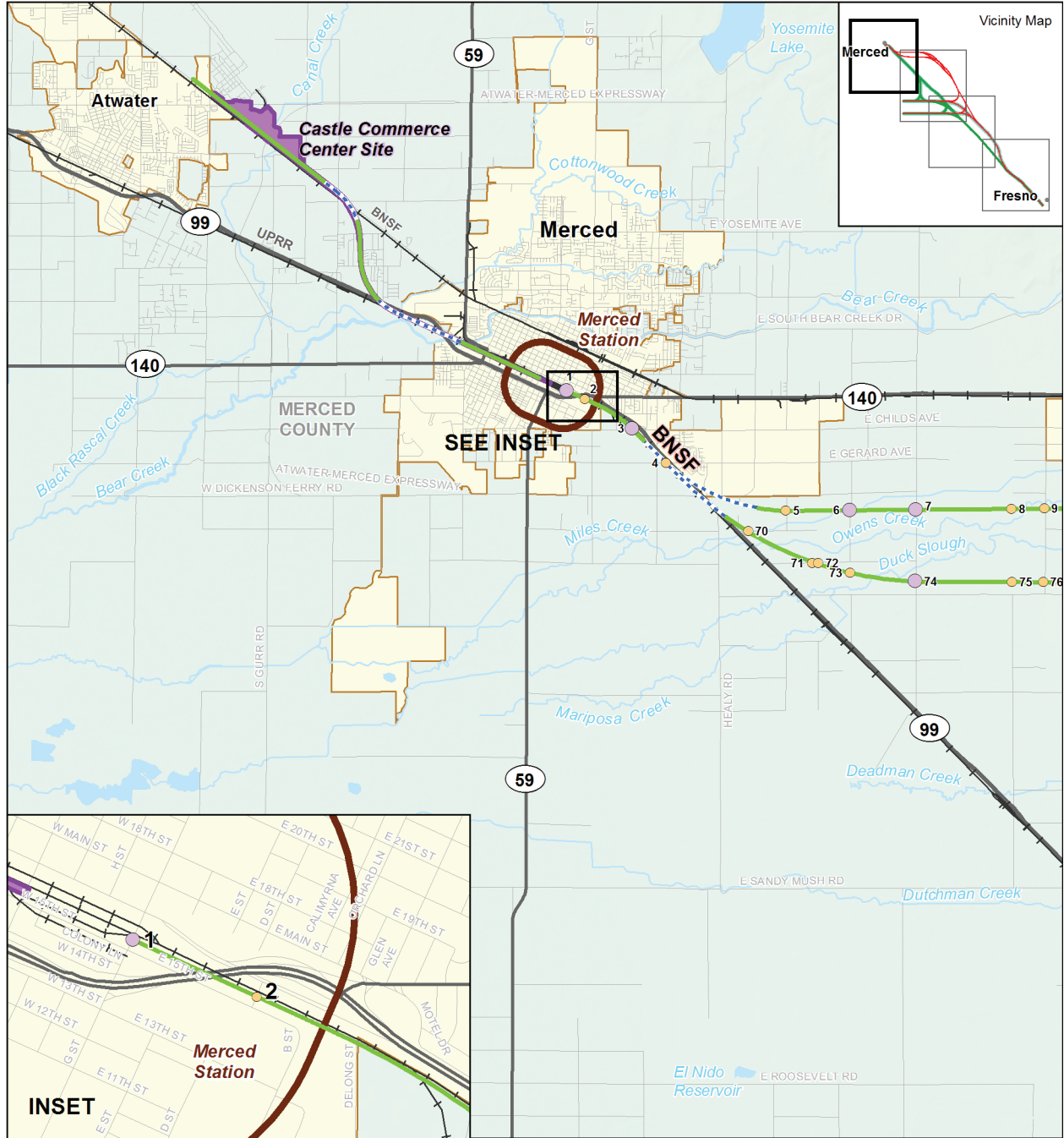

MF_EIS_PD_33_a Dec 13, 2011

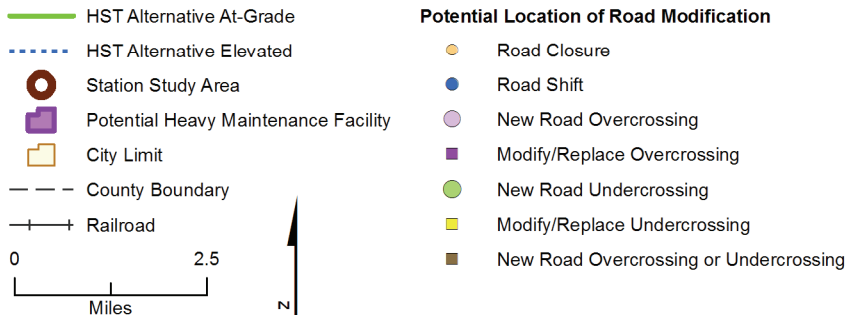

Figure 2-47
 BNSF Alternative in the
 Merced Project Vicinity

Chowchilla Vicinity (Deadman Creek to Dry Creek)

Continuing southeast along the west side of BNSF, the HST alternative would begin to curve just before Plainsburg Road through a predominantly rural and agricultural area. One mile south of Le Grand, the HST alignment would cross Deadman and Dutchman creeks. The HST alternative would deviate from the BNSF corridor just southeast of South White Rock Road, where it would remain at-grade for another 7 miles, except at the bridge crossings, and would continue on the west side of the BNSF corridor through the community of Sharon. The HST alignment would continue at-grade through the community of Kismet until reaching the crossing at Dry Creek.

Figure 2-49 shows the alignment of the BNSF Alternative through the Chowchilla vicinity, including where the guideway would be at-grade and elevated. The figure also shows the locations of modified public roads and the waterways that the HST would cross. There are no design options in the Chowchilla vicinity.

The TPSS in this vicinity would connect to an existing PG&E substation on Porters Road near South Minturn Road via an existing overhead power line that passes near the TPSS site. The overhead line would be upgraded to 115 kV for approximately 24,000 feet to provide adequate power supply for the TPSS needs in this location.

Madera Vicinity (Dry Creek to San Joaquin River)

The BNSF Alternative would cross Dry Creek and continue at-grade through agricultural areas along the west side of the BNSF corridor through the community of Madera Acres north of the City of Madera (see Figure 2-50). The HST alignment would continue at-grade on the west side of the BNSF corridor, crossing over the Fresno River and SR 145. This would involve raising the HST tracks over the existing SR 145 undercrossing. South of Avenue 15 east of Madera, the alignment would transition toward the UPRR corridor. The alignment would follow the east side of the UPRR corridor near Avenue 9 south of Madera, and then would continue along nearly the same route as the UPRR/ SR 99 Alternative over the San Joaquin River to enter the community of Herndon. Figure 2-50 shows where the HST alignment would be at-grade and elevated; it also shows affected public roads in the Madera vicinity and the waterways that the HST would cross.

The BNSF Alternative in combination with the Ave 24 Wye would have a TPSS in this vicinity that connect to the existing PG&E Substation Storey via an existing 115-kV overhead power line that passes near the TPSS site. New overhead line would be provided for approximately 1,000 linear feet to connect the TPSS to existing power supplies. The BNSF Alternative in combination with the Ave 21 Wye would have a TPSS in this vicinity that would connect to an existing PG&E substation on Avenue 12 via an overhead power line that passes near the TPSS site. New overhead line would be provided for approximately 500 feet to connect the TPSS to existing power supplies.

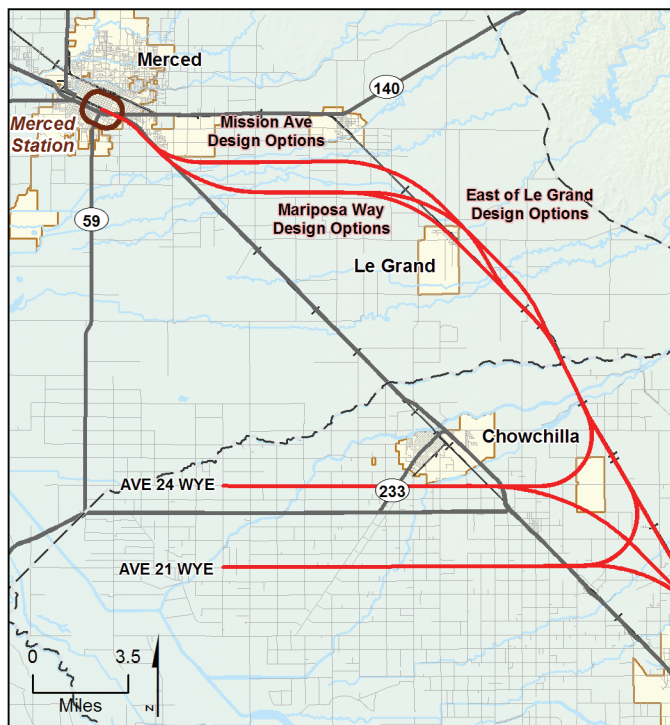

- BNSF Alignment
- Station Study Area
- City Limit
- County Boundary
- Railroad
- State / US Highway

Figure 2-48
 Mission Ave and Mariposa Way
 Design Options in the
 Merced Project Vicinity

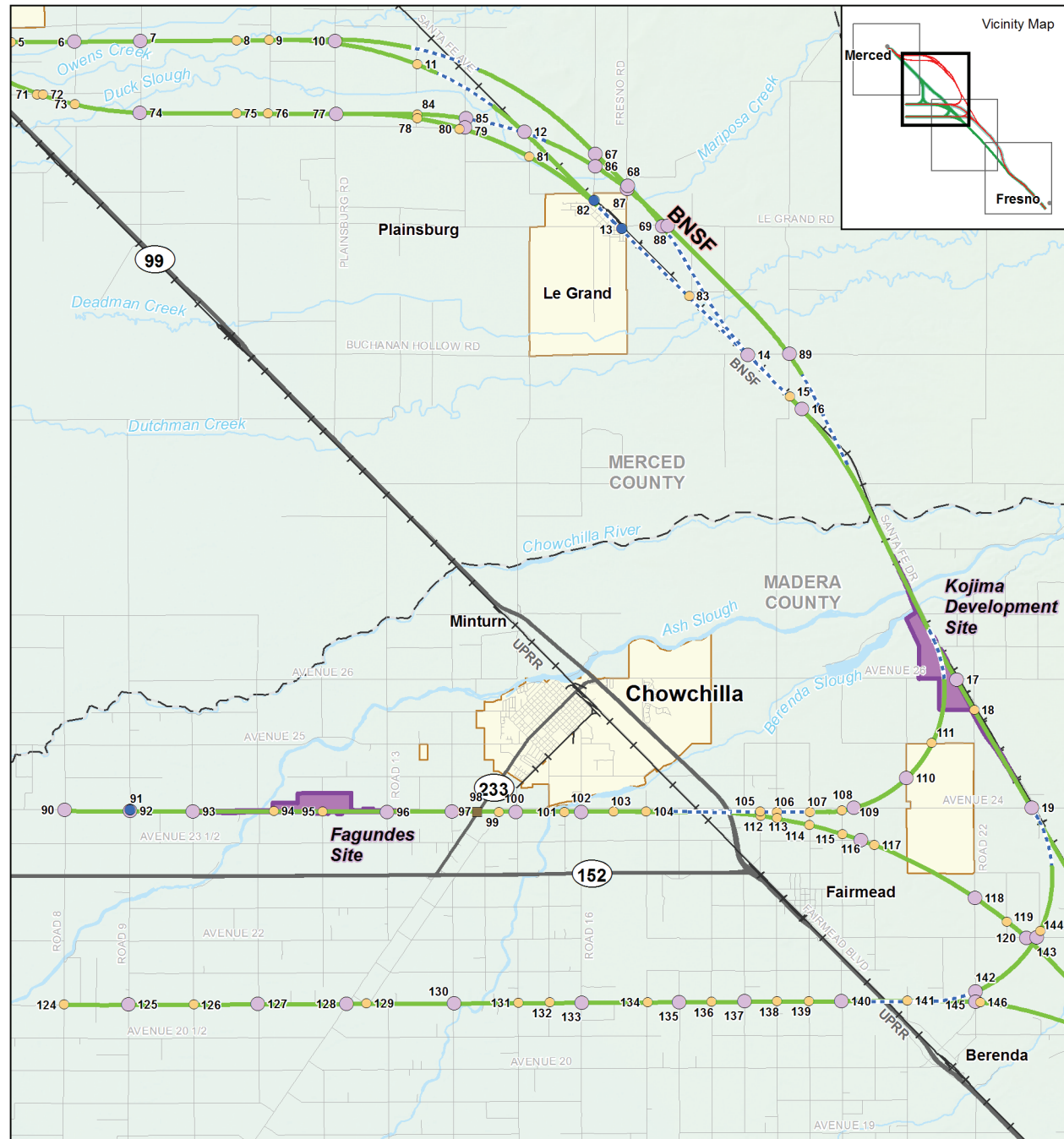

MF_EIS_PD_33_b Dec 14, 2011

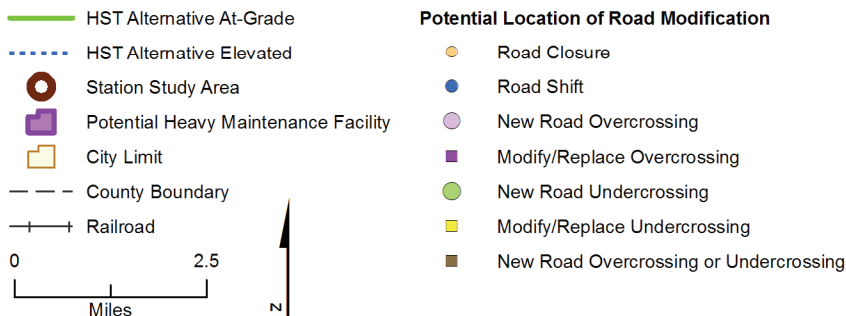
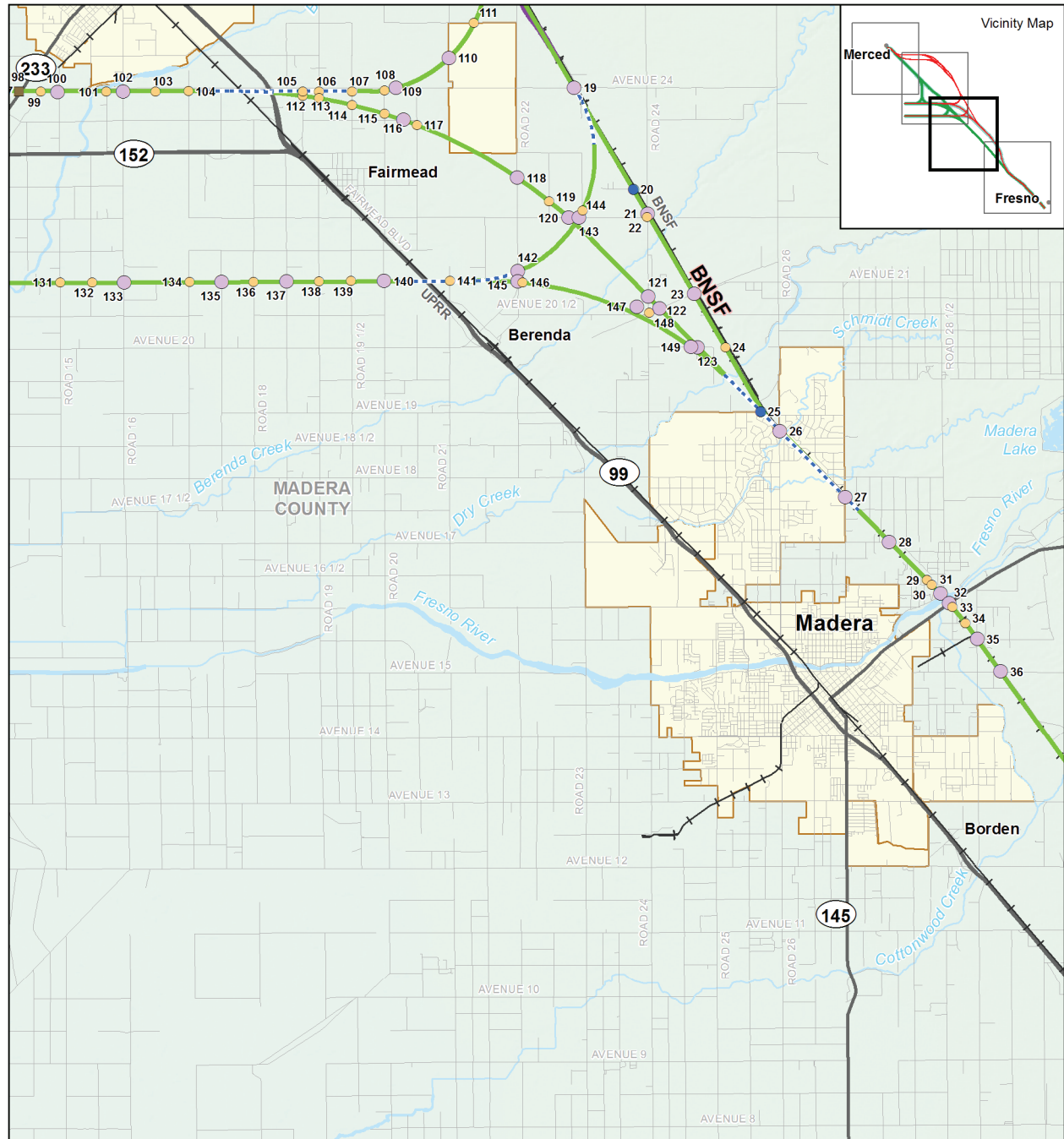

Figure 2-49
 BNSF Alternative in the
 Chowchilla Project Vicinity



MF_EIS_PD_33_c Dec 13, 2011

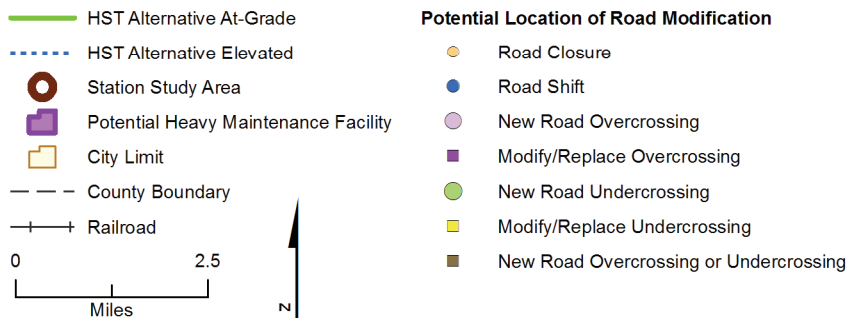

Figure 2-50
 BNSF Alternative in the
 Madera Vicinity

Fresno Vicinity (San Joaquin River to Fresno Station)

The HST alignment for the BNSF Alternative in the Fresno vicinity would be the same as for the UPRR/SR 99 Alternative (see Fresno Vicinity under Section 2.4.2.2). Roadway changes would be the same as for the Fresno vicinity for the UPRR/SR 99 Alternative as shown in Figure 2-51.

2.4.3.3 Wye Design Options

The Ave 24 Wye and the Ave 21 Wye would be the same as described for the UPRR/SR 99 Alternative, except as noted below. Figures 2-49 and 2-50 show public road modifications for the wye connections.

Ave 24 Wye

As with the UPRR/SR 99 Alternative, the Ave 24 Wye would follow along the south side of Avenue 24 and would begin diverging into two sets of tracks (i.e., four tracks) beginning west of Road 17. Two tracks would travel north near Road 20½, where they would join the BNSF Alternative north-south alignment on the west side of the BNSF corridor near Avenue 26½. The two southbound tracks would join the BNSF Alternative on the west side of the BNSF corridor south of Avenue 21. The crossing of SR 233 could be over or under the HST tracks. See Figure 2-49, which shows where the alignment would be at-grade and elevated, as well as affected public roads.

Ave 21 Wye

As with the UPRR/SR 99 Alternative, the Ave 21 Wye would travel along the north side of Avenue 21. While Madera County may consider the possibility of vacating the roadway to help minimize impacts on adjacent farmlands, the design of the Ave 21 Wye currently remains positioned north of the Avenue 21 right-of-way. Two tracks would diverge, turning north and south to connect to the BNSF Alternative just west of Road 21. The north leg would join the north-south alignment just south of Avenue 24 and the south leg would join the north-south alignment just east of Frontage Road/Road 26 north of the community of Madera Acres. See Figure 2-50, which shows where the alignment would be at-grade and elevated, as well as affected public roads.

2.4.3.4 Stations

The station options for the BNSF Alternative are the same as those described for the UPRR/SR 99 Alternative.

2.4.4 Hybrid Alternative (Preferred Alternative)

2.4.4.1 Description of Alternative and Design Options

This section describes the UPRR/SR 99 and BNSF Hybrid Alternative (hereinafter referred to as the Hybrid Alternative). From north to south, generally, the Hybrid Alternative would follow the UPRR/SR 99 alignment with either the West Chowchilla design option and Ave 24 Wye or the East Chowchilla design option and Ave 21 Wye; at the Wye connection, it would join the BNSF Alternative through Madera and would continue south over the San Joaquin River on to the Fresno station. Figures 2-52a and 2-52b show each of the Hybrid Alternative north-south alignment and wye combinations from Merced to Fresno. The design drawings that show the track alignments, profiles, structures, typical sections, construction use area, and other preliminary design information are included as Volume III (Alignments and Other Plans) of the EIR/EIS, available on the Authority's web site at (www.cahighspeedrail.ca.gov) or CD upon request.

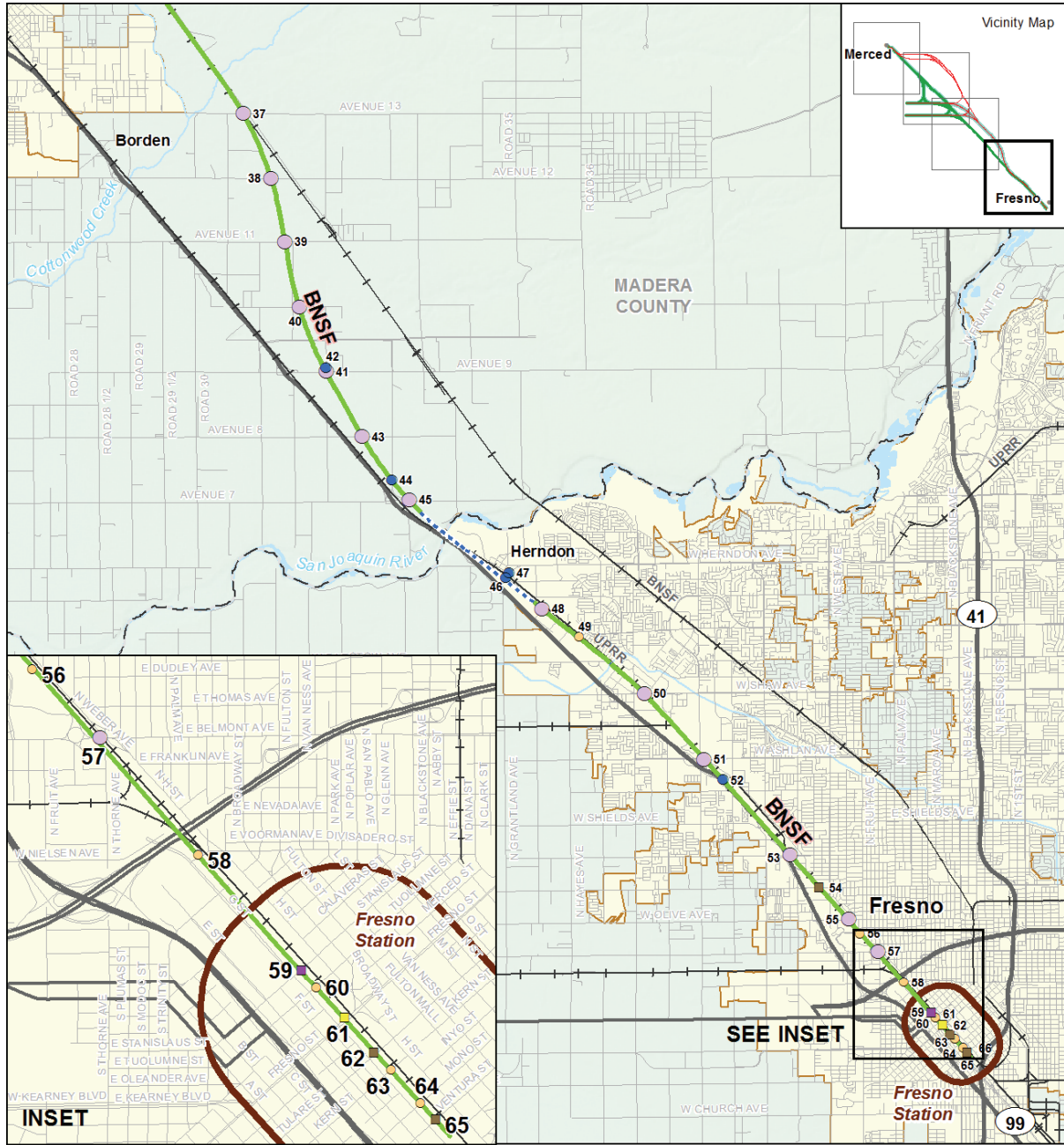

MF_EIS_PD_33_d Apr 05, 2012

- | | |
|--|--|
| <ul style="list-style-type: none"> — HST Alternative At-Grade - - - HST Alternative Elevated Station Study Area Potential Heavy Maintenance Facility City Limit County Boundary Railroad | <p>Potential Location of Road Modification</p> <ul style="list-style-type: none"> ● Road Closure ● Road Shift ● New Road Overcrossing ■ Modify/Replace Overcrossing ● New Road Undercrossing ■ Modify/Replace Undercrossing ■ New Road Overcrossing or Undercrossing |
|--|--|

Figure 2-51
 BNSF Alternative in the
 Fresno Project Vicinity

Merced Vicinity (Merced Station to Deadman Creek)

The HST alignments in the Merced vicinity for the Hybrid Alternative and design options are the same as for the UPRR/SR 99 Alternative (see Merced Vicinity under Section 2.4.2.2). Roadway changes would be the same as those listed for the UPRR/SR 99 Alternative in the Merced vicinity, as shown in Figure 2-53. The TPSS for the Hybrid Alternative with the Ave 24 Wye would be the same as that for the UPRR/SR 99 Alternative with the Ave 24 Wye in the Merced vicinity.

Chowchilla Vicinity (Deadman Creek to Dry Creek)

Approaching the Chowchilla city limits, the Hybrid Alternative would follow one of two options.

Ave 24 Wye Option. In conjunction with the Ave 24 Wye connection, the HST alignment would veer due south from Sandy Mush Road along a curve and would continue at-grade for 4 miles parallel to and on the west side of Road 11¾. The Hybrid Alternative would then curve to a corridor on the south side of Avenue 24 and would travel parallel for the next 4.3 miles. Along this curve, the southbound HST track would become an elevated structure for approximately 9,000 feet to cross over the Ave 24 Wye connection tracks and Ash Slough, while the northbound HST track would remain at-grade. Continuing east on the south side of Avenue 24, the HST alignment would become identical to the Ave 24 Wye connection for the BNSF Alternative (Section 2.4.3.3) and would follow the BNSF Alternative alignment until Madera. See Figure 2-52a.

Ave 21 Wye Option. In conjunction with the Ave 21 Wye connection, the HST alignment would transition from the west side of UPRR and SR 99 to an elevated structure as it crosses the UPRR and N Chowchilla Boulevard just north of Avenue 27, continuing on an elevated structure along the west side of and parallel to SR 99 away from the UPRR corridor while it crosses Berenda Slough. Toward the south side of Chowchilla, the alignment with the Ave 21 Wye would cross over SR 99 north of the SR 99/SR 152 interchange near Avenue 23½ south of Chowchilla. It would continue to follow along the east side of SR 99 until reaching Avenue 21, where it would curve east and run parallel to Avenue 21 briefly. The alignment would then follow a path similar to the Ave 21 Wye connection for the BNSF Alternative, but with a tighter 220 mph curve. The alternative would then follow the BNSF Alternative alignment until Madera. Figure 2-54 shows public roadway changes and the waterways that the HST would cross. The TPSS for the Hybrid Alternative with the Ave 21 Wye in the Chowchilla vicinity would be the same as that for the UPRR/SR 99 Alternative with the Ave 21 Wye, connecting to the existing PG&E substation on Porters Road near South Minturn Road. See Figure 2-52b.

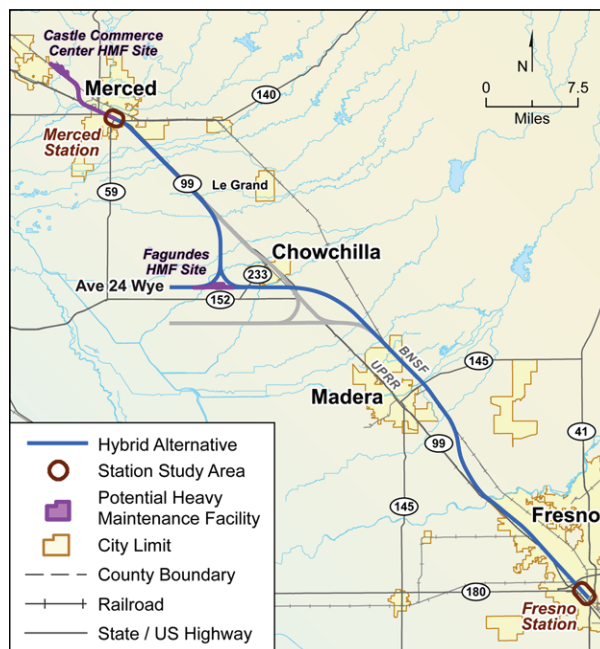

Figure 2-52a
 Hybrid Alternative with Ave 24 Wye

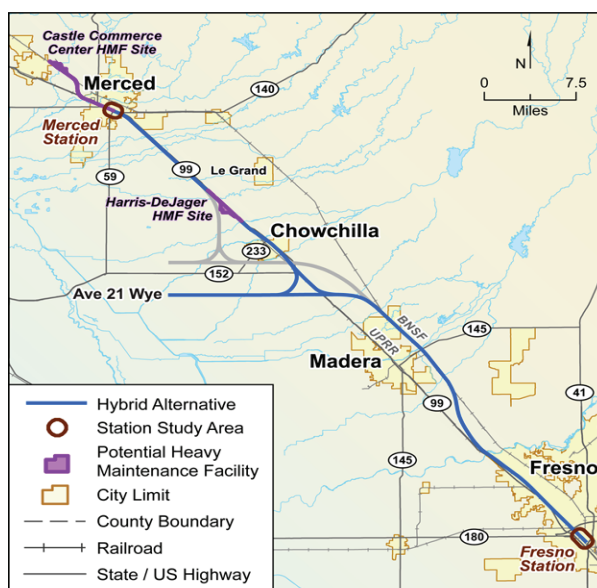
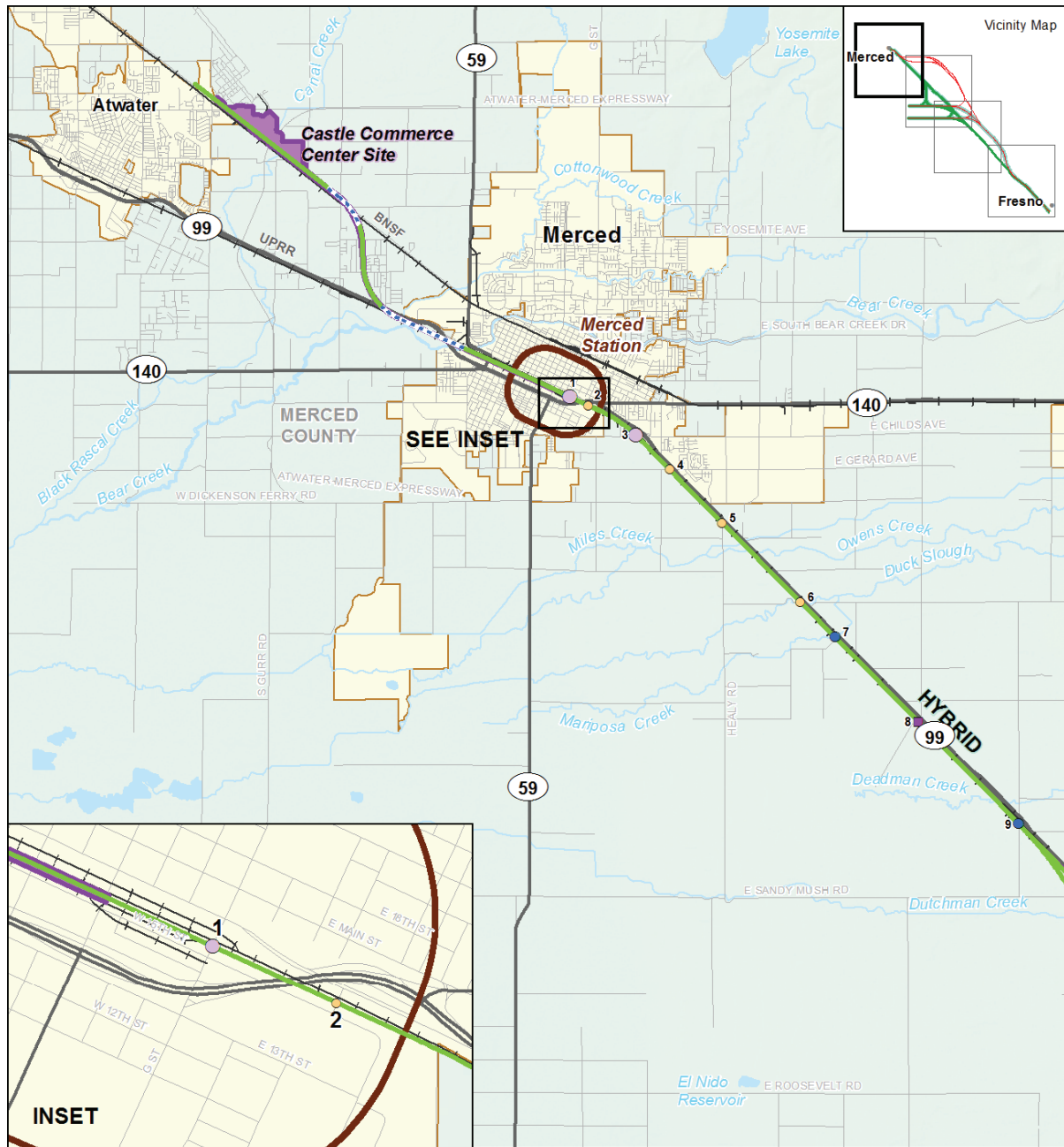

Figure 2-52b
 Hybrid Alternative with Ave 21 Wye



MF_EIS_PD_34_a Apr 05, 2012

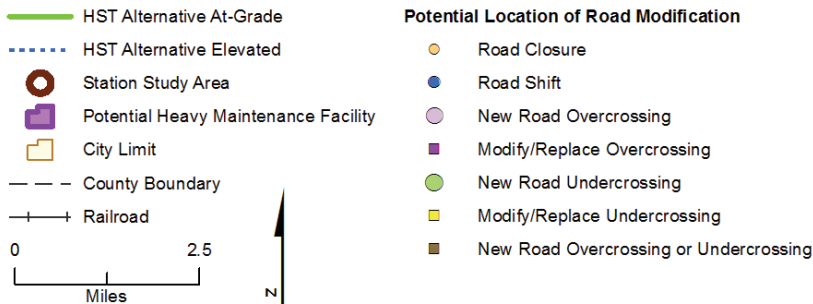

Figure 2-53
 Hybrid Alternative in the
 Merced Project Vicinity

Madera Vicinity (Dry Creek to San Joaquin River)

Throughout the Madera vicinity, the Hybrid Alternative is the same as for the BNSF Alternative (see Madera Vicinity under Section 2.4.3.2). Figure 2-55 shows the public roadway changes. The HST crossing of SR145 would leave the existing roadway configuration and raise the HST tracks over the SR 145 undercrossing.

The TPSS for the Hybrid Alternative with the Ave 24 Wye in the Madera vicinity would be the same as that for the BNSF Alternative with the Ave 24 Wye, connecting to the existing PG&E Substation Storey. The TPSS for the Hybrid Alternative with the Ave 21 Wye in the Madera vicinity would be the same as that for the BNSF Alternative with the Ave 21 Wye, connecting to the existing PG&E substation on Avenue 12.

Fresno Vicinity (San Joaquin River to Fresno Station)

Throughout the Fresno vicinity, the Hybrid Alternative is the same as for the UPRR/SR 99 Alternative (see Fresno Vicinity under Section 2.4.2.2). Figure 2-56 shows the public roadway changes, all of which are the same as those listed for the UPRR/SR 99 Alternative in the Fresno vicinity.

2.4.4.2 Wye Connection Design

The wye connections for the Hybrid Alternative follow Avenue 24 and Avenue 21, similar to those of the UPRR/SR 99 and BNSF alternatives.

Ave 24 Wye

The Ave 24 Wye is the same as the combination of the UPRR/SR 99 Alternative with the West Chowchilla design option, and the Ave 24 Wye for the BNSF Alternative. The crossing of SR 233 could be over or under the HST tracks. Figure 2-54 shows the public roadways affected by the Ave 24 Wye for the Hybrid Alternative.

Ave 21 Wye

The Ave 21 Wye is similar to the combination of the UPRR/SR 99 Alternative with the Ave 21 Wye on the northbound leg and the BNSF Alternative with the Ave 21 Wye on the southbound leg. However, the south leg under the Hybrid Alternative would follow a tighter, 220 mph curve than the BNSF Alternative, which follows a 250 mph curve. Figure 2-54 shows the public roadways affected by the Ave 21 Wye for the Hybrid Alternative.

2.4.4.3 Stations

The station options for the Hybrid Alternative are the same as those described for the UPRR/SR 99 and BNSF alternatives.

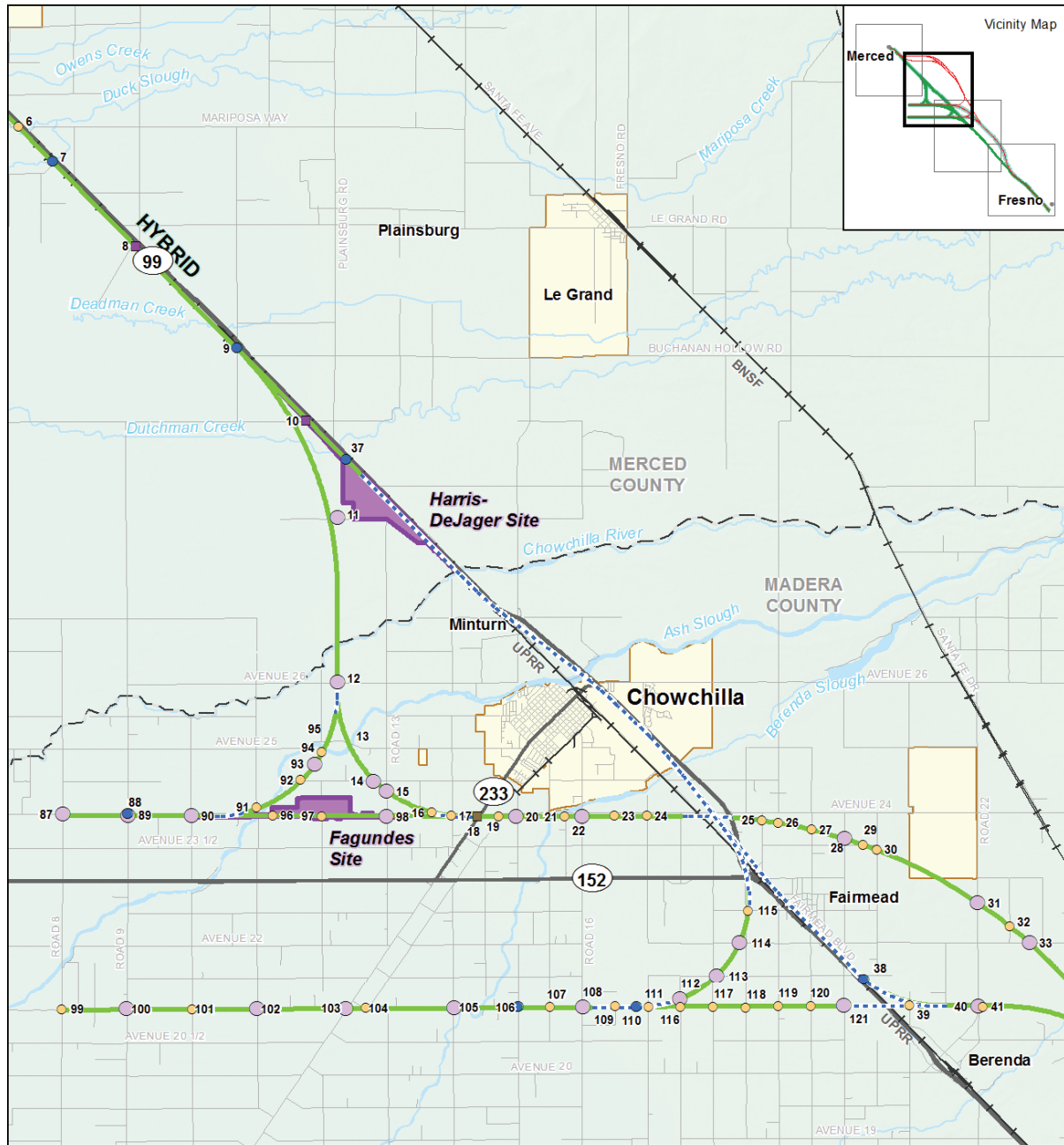

MF_EIS_PD_34_b Apr 05, 2012

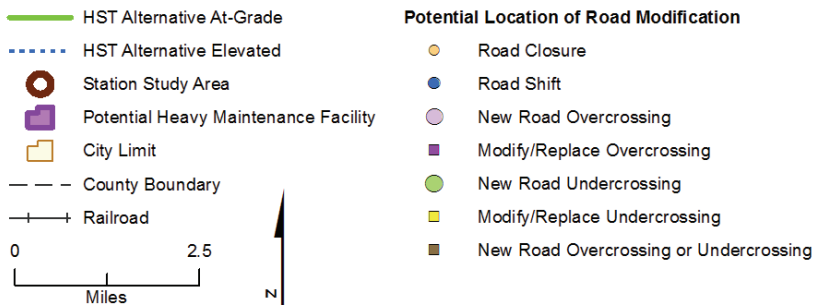
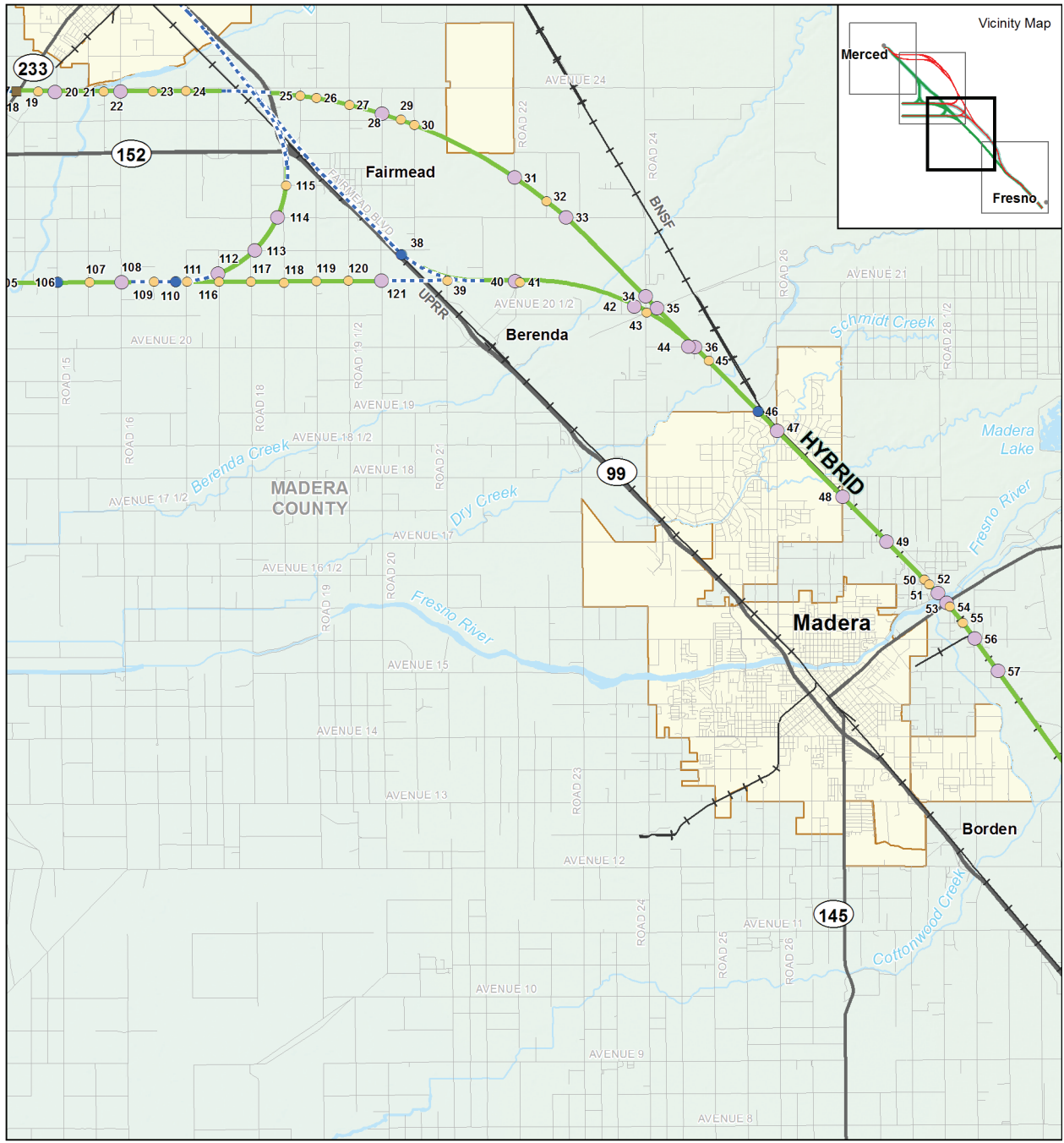

Figure 2-54
 Hybrid Alternative in the
 Chowchilla Vicinity



MF_EIS_PD_34_c Dec 14, 2011

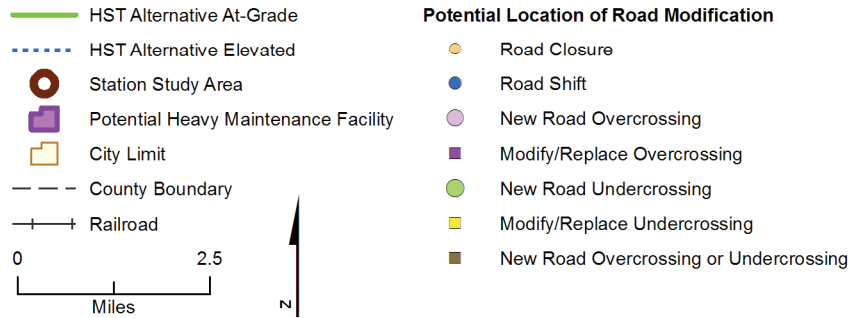
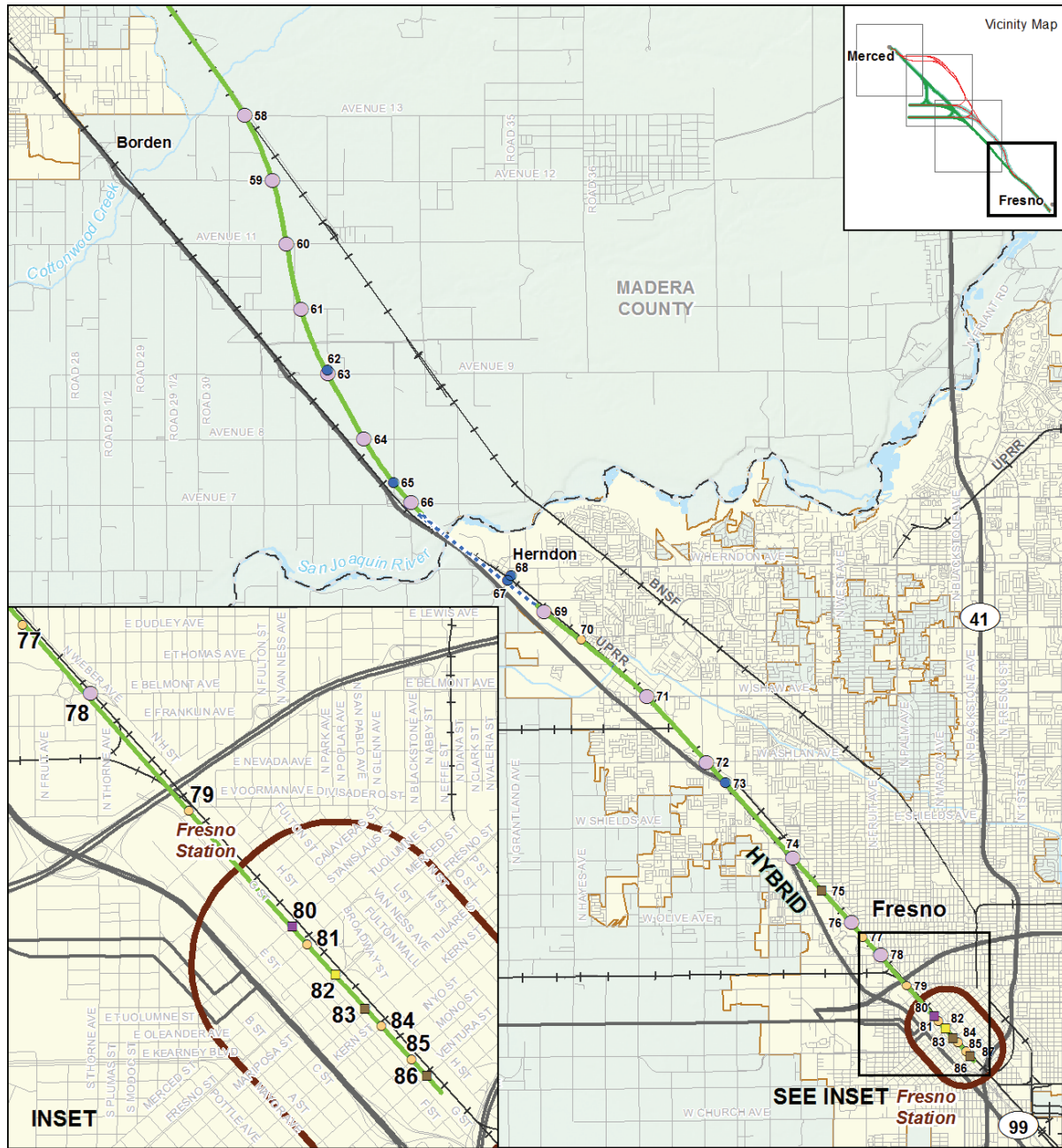

Figure 2-55
 Hybrid Alternative in the Madera Vicinity



MF_EIS_PD_34_d Apr 05, 2012

Figure 2-56
 Hybrid Alternative in the
 Fresno Project Vicinity

2.4.5 Modification of Caltrans/State Facilities

As discussed above, all of the Merced to Fresno Section alternatives and wye connections, along with the associated San Jose to Merced Section wye connections (along Avenues 24 or 21), would cross state route facilities. Depending on the HST guideway type at these crossings, the HST guideway would require construction easement, easement for columns within a state facility, modification or replacement of overcrossings or interchanges, or in the case of SR 99 in Fresno, realignment of state routes.

Figure 2-57 shows the location of the affected state facilities for each of the three HST alternatives. Table 2-12 identifies the facility and summarizes impacts caused by the HST alternatives.

Typically, locating an HST guideway adjacent to the UPRR or SR 99 will require reconfiguration of the interchanges, overcrossings, and local roadway systems to maintain their function. In addition, there would be an undercrossing under SR 180 in Fresno. The following sections provide brief examples of how state facilities may have to be modified due to close proximity of the HST alternatives.

2.4.5.1 State Highway Overcrossings

Under the UPRR/SR 99 Alternative, the at-grade HST alignment often lies adjacent and parallel to the UPRR and SR 99. Caltrans' facilities such as the Avenue 8 and 11 overcrossings in Madera County (items 24 and 22, respectively, in Table 2-12 and Figure 2-57) consist of local road overcrossings of SR 99 and UPRR tracks. Figure 2-58 shows a typical, lengthened overcrossing of a divided highway.

Where traffic is light, in-place construction of the overcrossing would occur, meaning the overcrossing would be demolished and then replaced on the same alignment. In locations where it is necessary to maintain existing traffic conditions, construction of the replacement structure would take place before demolishing the existing structure. Figure 2-59 shows the lengthened overcrossing at Avenue 11.

2.4.5.2 Highway Interchanges, Ramps, and Approaches

The Avenue 9 and Avenue 18½ interchanges in Madera County (items 23 and 17, respectively, in Table 2-12 and on Figure 2-57) connect local roads with SR 99. Replacing interchanges in place, or shifting them (as shown in Figure 2-60), will require modifications to the highway on- and off-ramps, as well as more extensive modifications to local roads, intersections, and access roads.

2.4.5.3 Frontage Roads and State Highways Access

A common condition in rural areas is a frontage road that parallels a railroad or highway with existing at-grade or overcrossing access to highway on- and off-ramps, similar to the Arboleda interchange shown in Figure 2-61. Construction of the HST alternatives adjacent to UPRR or SR 99 often will require modifications to frontage roads and their access to state highways in order to provide the required clearance over the HST, or to close an existing at-grade crossing condition.

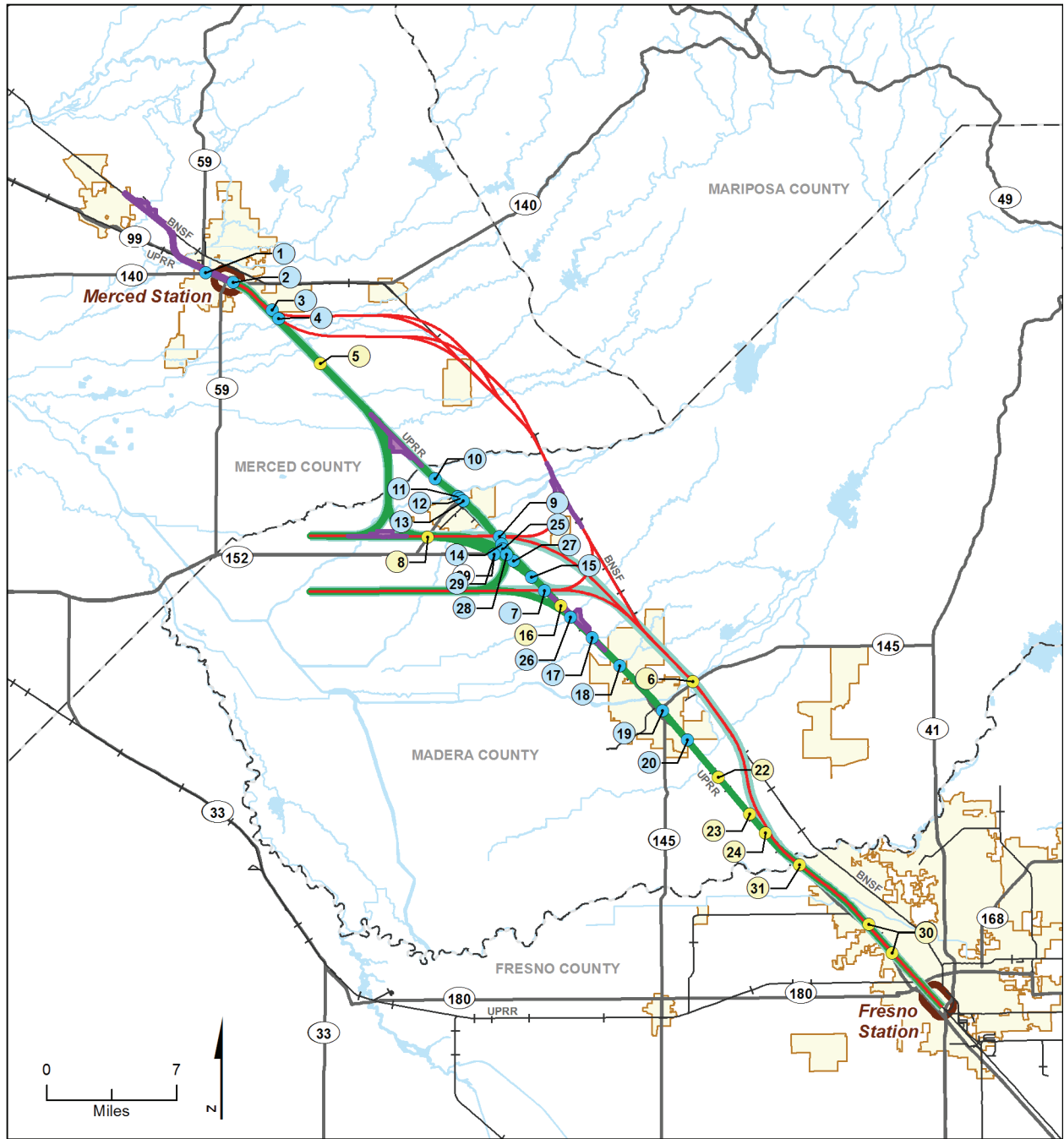

MF_EIS_PD_36 Jun 09, 2011

- | | | |
|--------------------------------------|-----------------|--|
| UPRR/SR 99 Alternative | City Limit | Affected State Route Facility |
| BNSF Alternative | County Boundary | Existing Facility to be Modified/Rebuilt |
| Hybrid Alternative | Railroad | HST Over Existing Facility |
| Station Study Area | | |
| Potential Heavy Maintenance Facility | | |

Figure 2-57
 Location of State Facilities Affected
 by HST Alternatives

Table 2-12
Impact of HST Alternatives on Caltrans State Facilities

No.	Dist-County-Hwy-PM ^a	Location	Requirements		HST Alternative
			Modify	Encroachment	
1	10-Mer-99 (PM 14.9)	SR 99 Mainline Crossover near W 15th Street		X	ALL
2	10-Mer-99 (PM 14.2)	SR 99 Mainline Crossover near 15th Street Undercrossing		X	ALL
3	10-Mer-99 (PM 11.7)	SR 99/E Mission Ave Interchange		X	BNSF - Mission
4	10-Mer-99 (PM 10.2)	SR 99 Mainline Crossover near E Mission Ave		X	BNSF - Mariposa
5	10-Mer-99 (PM 4.5)	SR 99/Plainsburg (PM 0.0 – 4.6) and Arboleda (PM 4.6 – 10.5) Interchange ^a	x		UPRR/SR 99 & Hybrid
6	06-Mad-145 (PM 12.1)	SR 145 Undercrossing near Road 28½	x		BNSF & Hybrid
7	06-Mad-99 (PM 19.8)	SR 99 Mainline Crossover near Ave 21		X	BNSF & Hybrid
8	06-Mad-233 (PM 1.1)	SR 233 Overcrossing near Ave 23½	x		UPRR/SR 99 & Hybrid
9	06-Mad-99 (PM 23.7)	SR 99 Mainline Crossover near Ave 24		X	BNSF & Hybrid
10	06-Mad-99 (PM 28.5)	SB SR 99 On- and Off-Ramps near Chowchilla Blvd		X	UPRR/SR 99 & Hybrid
11	06-Mad-233 (PM 3.8)	SB SR 99 Off-Ramp		X	UPRR/SR 99 & Hybrid
12	06-Mad-233 (PM 3.9)	SR 233 Mainline Crossover near SR 99/SR 233 Junction		X	UPRR/SR 99 & Hybrid
13	06-Mad-233 (PM 4.0)	SB SR 99 On-Ramp		X	UPRR/SR 99 & Hybrid
14	06-Mad-99 (PM 23.2)	SR 99 Mainline Crossover near SR 99/SR 152 Junction		X	UPRR/SR 99 & Hybrid

No.	Dist-County-Hwy-PM ^a	Location	Requirements		HST Alternative
			Modify	Encroachment	
15	06-Mad-99 (PM 20.8)	SR 99 Avenue 21½/Road 20 Interchange		X	UPRR/SR 99
16	06-Mad-99 (PM 18.7R)	SR 99/Avenue 20 & 20½ Interchange	x		UPRR/SR 99
17	06-Mad-99 (PM 16.3)	SR 99/Avenue 18½ Interchange		X	UPRR/SR 99
18	06-Mad-99 (PM 14.2)	SR 99/Avenue 17 Interchange		X	UPRR/SR 99
19	06-Mad-145 (PM 9.4)	SR 145 mainline Crossover at 6th Street		X	UPRR/SR 99
20	06-Mad-99 (PM 8.7)	SR 99/Avenue 13 Overcrossing		X	UPRR/SR 99
22 ^b	06-Mad-99 (PM 6.2R)	SR 99/Avenue 11 Overcrossing	x		UPRR/SR 99
23	06-Mad-99 (PM 3.6R)	SR 99/Avenue 9 Interchange	x		UPRR/SR 99
24	06-Mad-99 (PM 2.2R)	SR 99/Avenue 8 Overcrossing	x		UPRR/SR 99
25	06-Mad-99 (PM 22.7)	SR 99 near SR 152 Junction		X	UPRR/SR 99 & Hybrid
26	06-Mad-99 (PM 17.9)	SR 99 Mainline Crossover near Avenue 20		X	UPRR/SR 99
27	06-Mad-99 (PM 22.1)	SR 99 Mainline Crossover near Road 19		X	UPRR/SR 99 & Hybrid
28	06-Mad-152 (PM 15.5)	SR 99/SR 152 Junction		X	UPRR/SR 99 & Hybrid
29	06-Mad-152 (PM 15.0)	SR 152 near Road 18		X	UPRR/SR 99
30	06-Fre-99 (PM 24.4-26.6)	SR 99 from Ashlan Ave to Clinton Ave	x		ALL
31	06-Fre-99 (PM 31.3-31.5)	SR 99 on/off-ramps to Herndon Ave	x		ALL

^a PM = post mile
^b Location 21 intentionally omitted

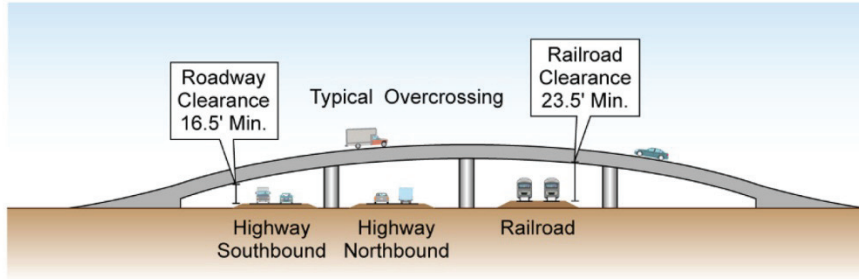

(a) Typical Overcrossing of Divided Highway and Railroad

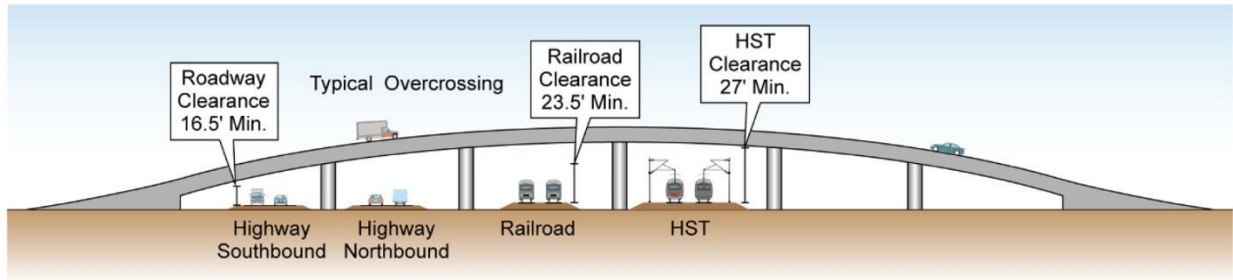

(b) Typical Overcrossing of Divided Highway, Railroad, and HST

Figure 2-58

Example of Lengthening an Overcrossing on a Divided Highway

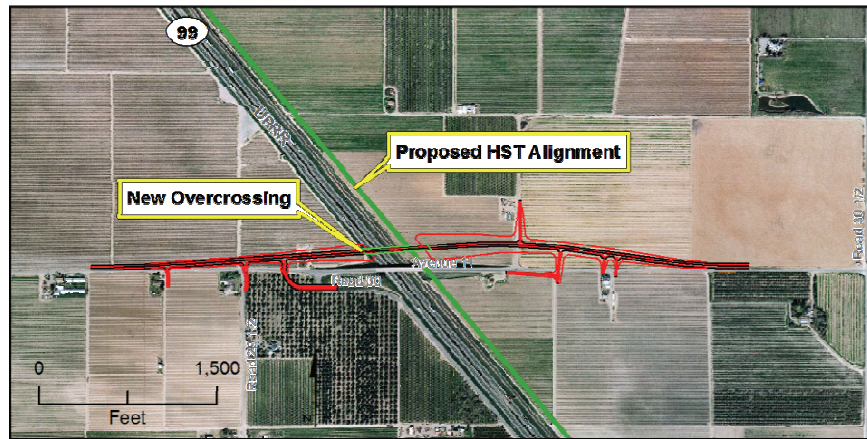

MF_EIS_PD_38 April 7, 2010

Figure 2-59

Overcrossing Replacement (Example: UPRR/SR 99 at Avenue 11)

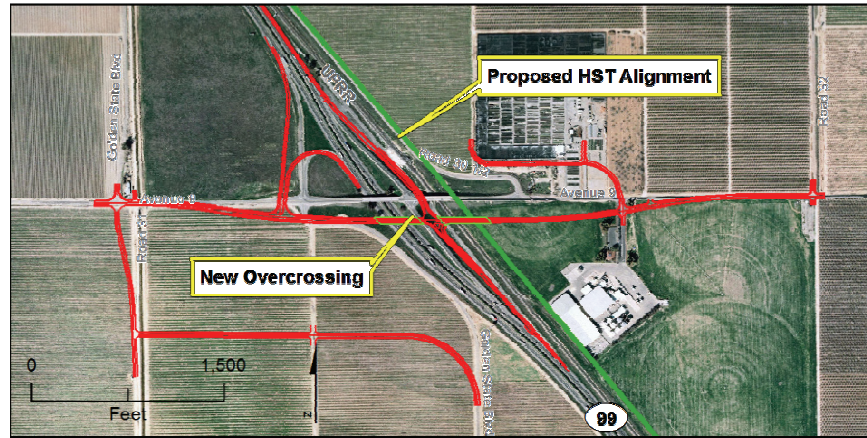

Figure 2-60
Interchange and Road System Replacement
(Example: UPRR/SR 99 at Avenue 9)

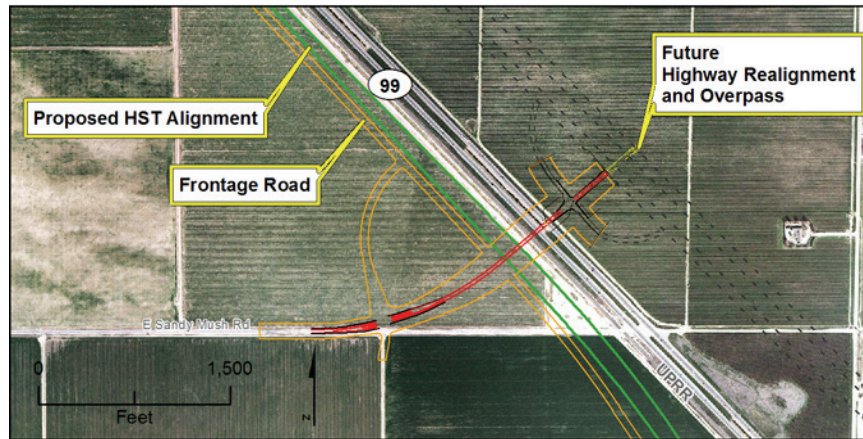

Figure 2-61
Frontage Road and Highway Access Modification
(Example: SR 99 Arboleda Interchange)

2.4.6 Proposed Heavy Maintenance Facility Locations

The Authority is studying five HMF sites within the Merced to Fresno Section. The sites vary in size, physical factors, and accessibility to the alternatives under study. Those analyzed in this EIR/EIS include the following:

- Castle Commerce Center, accessible by all HST alternatives.
- Harris-DeJager, accessible along the UPRR/SR 99 and Hybrid alternatives if coming from the Ave 21 Wye. (This site was withdrawn from consideration by the property owners on October 27, 2011 [Kopshever 2011].)
- Fagundes, accessible by all HST alternatives, via Ave 24 Wye.
- Gordon-Shaw, accessible along the UPRR/SR 99 Alternative.
- Kojima Development, accessible along the BNSF Alternative if coming from the Ave 21 Wye.

Figure 2-62 shows the locations proposed for the HMF; Table 2-13 describes each proposed HMF, its location, and property characteristics. The following sections describe how the access track would enter and exit the proposed HMF site and the proposed changes to the roadways to facilitate the access track.

Table 2-13
 Merced to Fresno Section HMF Site Descriptions

Name	Location/Description	Property Characteristics
Castle Commerce Center	370 acres of 178 available acres for proposed site footprint, thus requiring more land than is provided in the proposal ^a 6 miles northwest of Merced, at the former Castle Air Force Base in northern unincorporated Merced County. Adjacent to and on the east side of the BNSF mainline, 1.75 miles south of the UPRR mainline, off of Santa Fe Drive and Shuttle Road, 2.75 miles from existing SR 99 interchange. The site would require a spur track from the Merced Station and would not be central to the existing main line but would be central to the system-wide HST plan. Feasible alternative connections: UPRR/SR 99, BNSF, and Hybrid	Economic incentives: long-term lease for \$1/year, low-cost power, Enterprise Zone, Redevelopment Project Area. Recovery Zone financing potentially available. Foreign Trade Zone, Defense Base Realignment and Closure (BRAC) funding opportunities Mostly consistent with General Plan and zoning: Commercial, Industrial, Agriculture Outside of floodplain Direct highway access Utilities readily available Hazardous materials cleanup underway One business, one agriculture use to be displaced Intermittent stream onsite Cultural resource onsite
Harris-DeJager (This site was withdrawn from consideration on October 27, 2011.)	401 acres of 1,243 available acres for proposed site footprint ^a North of Chowchilla adjacent to and on west side of the UPRR corridor, along S Vista Road, near SR 99 interchange under construction Feasible alternative connections: UPRR/SR 99 and Hybrid, with Ave 21 Wye	Conditionally offered at no cost to the Authority Joint Powers Authority to provide financing for site and offsite improvements No floodplain Agricultural zoning, agricultural use displacement Wildlife corridor at northern boundary

Name	Location/Description	Property Characteristics
Fagundes	231 acres of 1,064 available acres for proposed site footprint; however, site would require adjacent land beyond proposal due to site configuration needs ^a 3 miles southwest of Chowchilla on north side of SR 152, between Road 11 and Road 12 Feasible alternative connections: UPRR/SR 99, BNSF, and Hybrid, with Ave 24 Wye	Joint Powers Authority to provide financing for site and offsite improvements Utilities readily available Roadway access from all directions Consistent with local land use plans Requires relocation of irrigation facilities Displacement of agriculture operations
Gordon-Shaw	364 acres of 472 available acres for proposed site footprint ^a Adjacent to and on east side of the UPRR corridor from north of Berenda Blvd to Avenue 19 Feasible alternative connections: UPRR/SR 99	Joint Powers Authority to assist in property acquisition and financing for infrastructure improvements California Annual Grassland, stream channel with mixed riparian forest Agriculture zoning, agriculture use displacement Partially in 100-year floodplain
Kojima Development	392 acres of 665 available acres for proposed site footprint ^a On BNSF corridor east of Chowchilla, along Santa Fe Drive and Robertson Blvd (Avenue 26), on the west side of the BNSF corridor Feasible alternative connections: BNSF with Ave 21 Wye	Part of the property conditionally offered at no cost to the Authority Eastman Lake dam failure inundation area Agriculture zoning, agriculture use displacement
^a Each HMF shows two acreages. The first value is the area that would be required for the HMF footprint and is the area analyzed for impacts. The second value is the total property area offered in the proposal for the facility.		

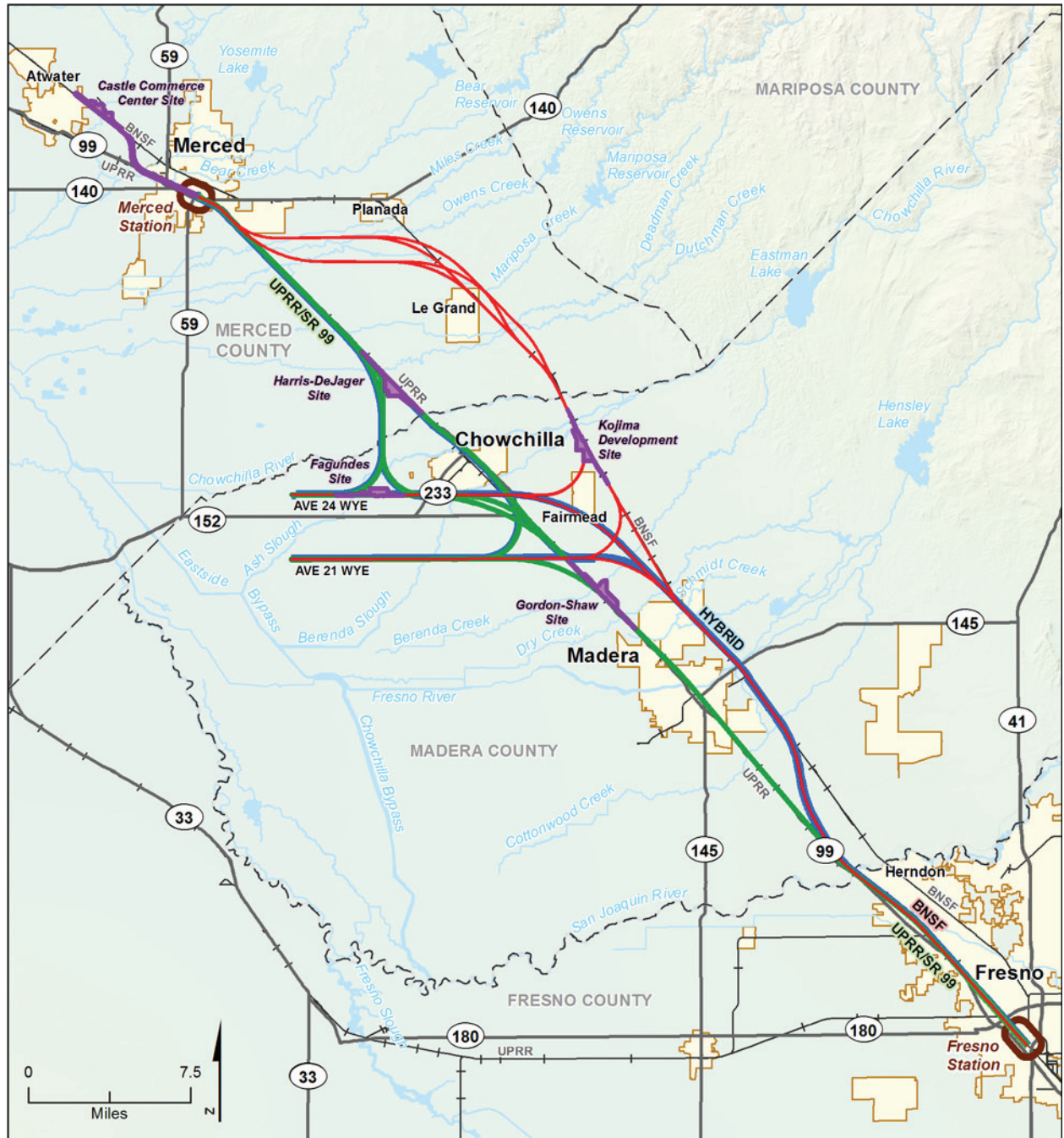

MF_EIS_PD_30 Jun 09, 2011

- BNSF Alternative
- UPRR/SR 99 Alternative
- Hybrid Alternative
- Station Study Area
- Potential Heavy Maintenance Facility
- City Limit
- County Boundary
- Railroad
- State / US Highway

Figure 2-62
 Locations of Proposed
 Heavy Maintenance Facility Sites

2.4.6.1 Castle Commerce Center Site

For the Castle Commerce Center site, the HST access tracks would extend northwest from the at-grade Downtown Merced Station on a 25- to 30-foot-tall retained fill to allow for undercrossing and gaining elevation to cross Bear Creek and SR 99 on the north side of downtown. The tracks would continue north to cross to the east side of the BNSF and Santa Fe Avenue through the Castle Commerce Center HMF site, entering the City of Atwater at West Bellevue Road. The tracks would continue north, ending at the Castle Air Museum. In Phase 1, access to this site would be through Merced. The decision remains to be made whether the HST would travel north to Sacramento along the BNSF or the UPRR; therefore, the connecting tracks from the north are not part of this study. Figure 2-63 shows the proposed Castle Commerce Center HMF property.

The access tracks extending north from the Downtown Merced Station would require a new overpass at Martin Luther King Jr. Way, and would then rise on retained fill to clear an undercrossing at the following locations:

- M Street
- R Street
- V Street
- Ashby Road
- Lobo Avenue
- Dan Ward Road
- Santa Fe Avenue/County Road 37
- Franklin Road
- West Cardella Road
- Wallace Road
- Shaffer Road

The access tracks extending north from the Downtown Merced Station would require closure of the following roadways:

- Canal Street
- Fox Road access to SR 99
- F Street access to SR 99
- Airdrome Entry/Buhach Road at Santa Fe Avenue

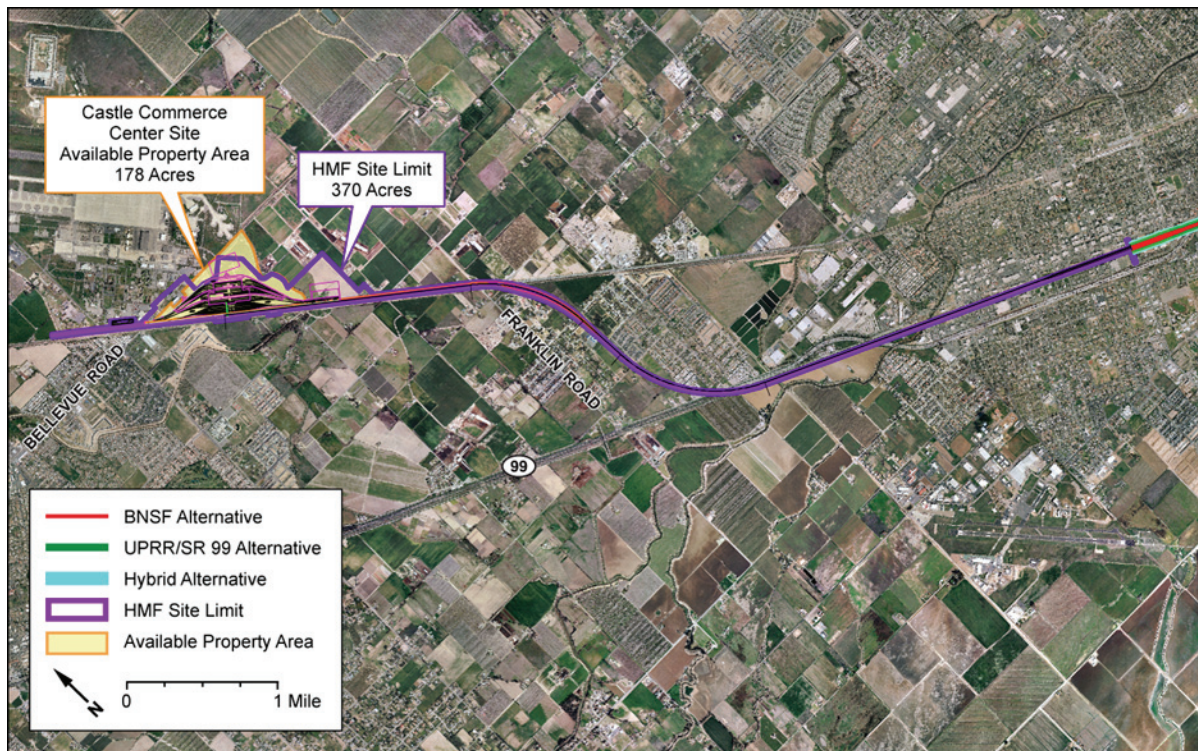

Figure 2-63
 Proposed Castle Commerce Center HMF Site

The access tracks extending north from the Downtown Merced Station would require shifting North Southern Pacific Avenue for approximately 0.9 mile. See the *Merced to Fresno Section Transportation Technical Report* (Authority and FRA 2012b) for additional details about road changes required for the Castle Commerce Center HMF.

The access tracks to the Castle Commerce Center HMF would cross over the following waterways:

- Bear Creek
- Black Rascal Creek
- Canal Creek

2.4.6.2 Harris-DeJager Site (Withdrawn from Consideration)

This site would be feasible only if the Ave 21 Wye were chosen because the Ave 24 Wye and the West Chowchilla Design Option present physical constraints. The Ave 24 Wye connects the east-west alignment from the west with the north-south alignment of the Merced to Fresno Section, resulting in four tracks just north of the Harris-DeJager site, exactly in the location where the HMF would require a three-track cross section to provide access to the site. Moving the HMF farther south would be limited by the Chowchilla River. The West Chowchilla design option would not provide multidirectional access, which is a criterion of the HMF site selection.

Access tracks would diverge from the UPRR/SR 99 Alternative's north-south alignment north of the HMF and south of Sandy Mush Road, and would then re-merge south of the HMF site north of the Chowchilla River. No new roadway crossings or shifts would occur from the access tracks that have not already been crossed or closed by the proposed UPRR/SR 99 Alternative. Figure 2-64 shows the proposed Harris-DeJager HMF property.

2.4.6.3 Fagundes Site

This site, which would be accessed by any of the HST alternatives via the Ave 24 Wye, lies on the south side of the Ave 24 Wye between Road 11 and Road 13. Access tracks would diverge from the Ave 24 Wye track and would then re-merge just east of Chowchilla east of Road 14. No new roadway crossings or shifts would occur from the access tracks that have not already been crossed or closed by the proposed Ave 24 Wye. Figure 2-65 shows the proposed Fagundes HMF property.

2.4.6.4 Gordon-Shaw Site

This site, which would be accessed from the UPRR/SR 99 Alternative, is located south of Chowchilla between Berenda Boulevard and Avenue 19 east of SR 99. Access tracks would diverge from the UPRR/SR 99 Alternative's north-south alignment to the north at Avenue 21 and would then re-merge south of the HMF site south of Avenue 18. No new roadway crossings or shifts would occur from the access tracks that have not already been crossed or closed by the proposed UPRR/SR 99 Alternative. Figure 2-66 shows the proposed Gordon-Shaw HMF site property.

2.4.6.5 Kojima Development Site

This site, which would be accessed from the BNSF Alternative if the Ave 21 Wye were selected, is located south of Le Grand and east of the City of Chowchilla and northwest of the intersection of Road 22 and Santa Fe Avenue. Access tracks would diverge from the BNSF Alternative's north-south alignment north of the HMF site and north of Ash Slough. The tracks would then re-merge south of the HMF site north of Avenue 24. No new roadway crossings or shifts would occur from the access tracks that have not already been crossed or closed by the proposed BNSF Alternative. Figure 2-67 shows the proposed Kojima Development HMF site property.

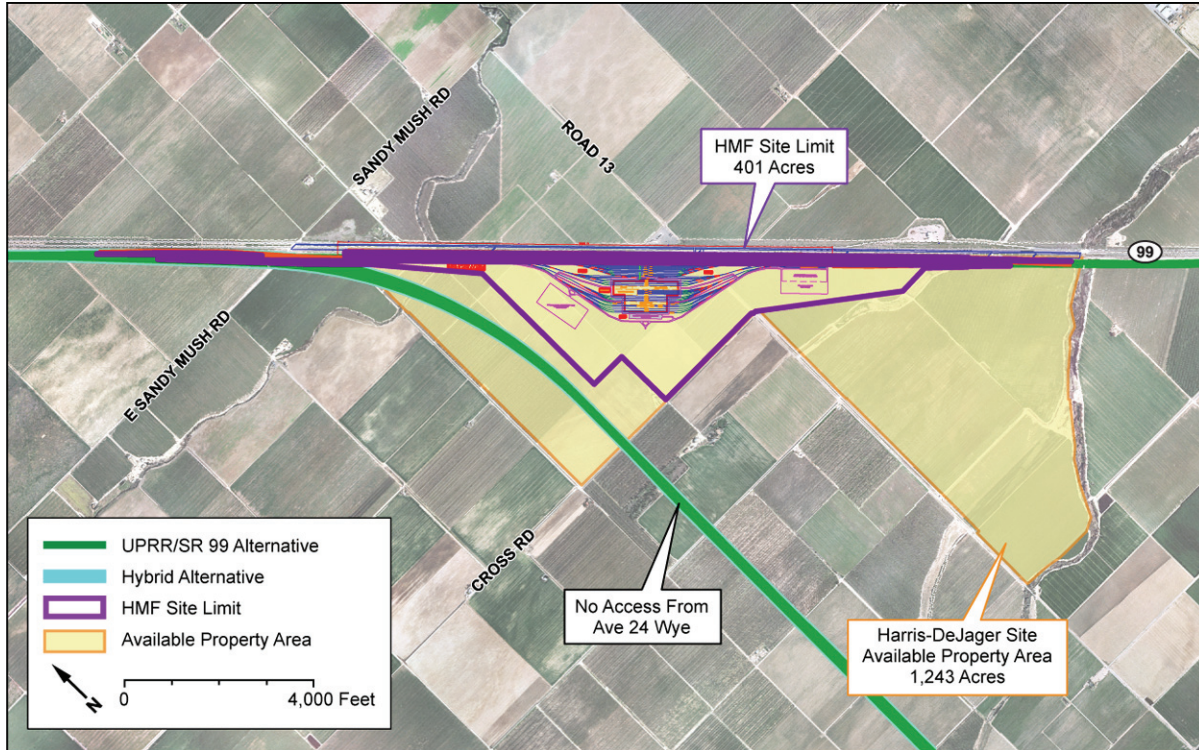

Figure 2-64
 Proposed Harris-DeJager HMF Site

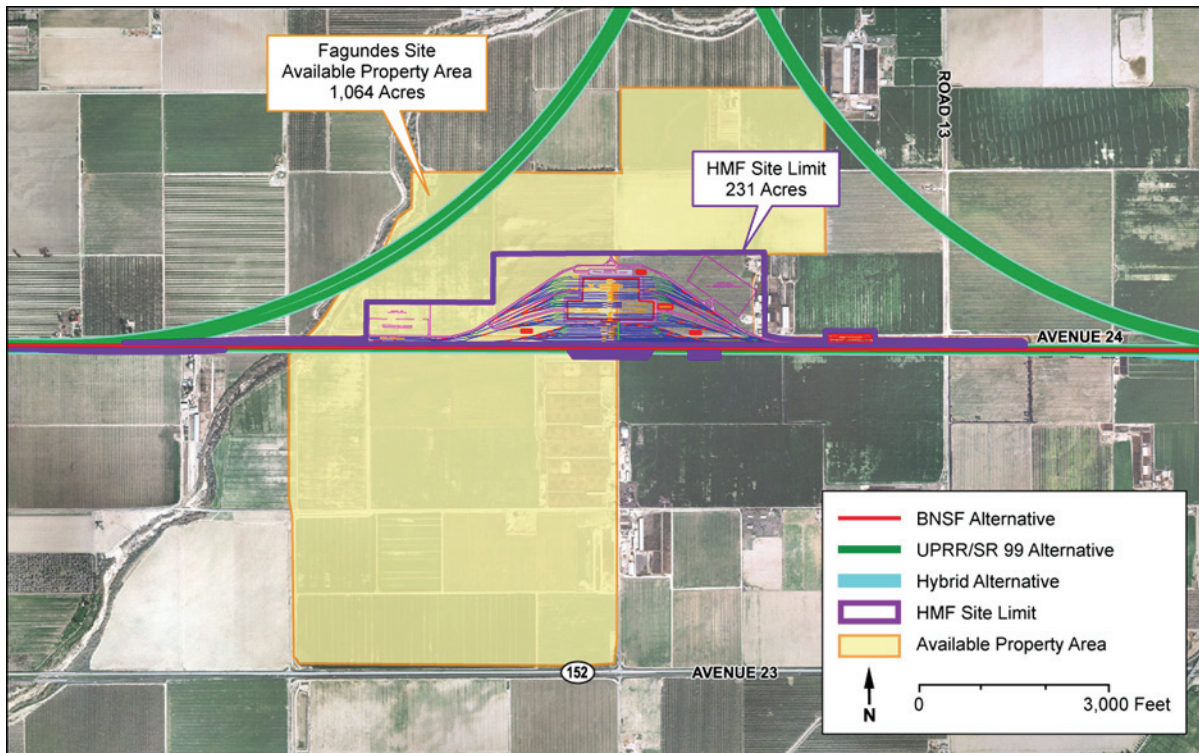

Figure 2-65
 Proposed Fagundes HMF Site

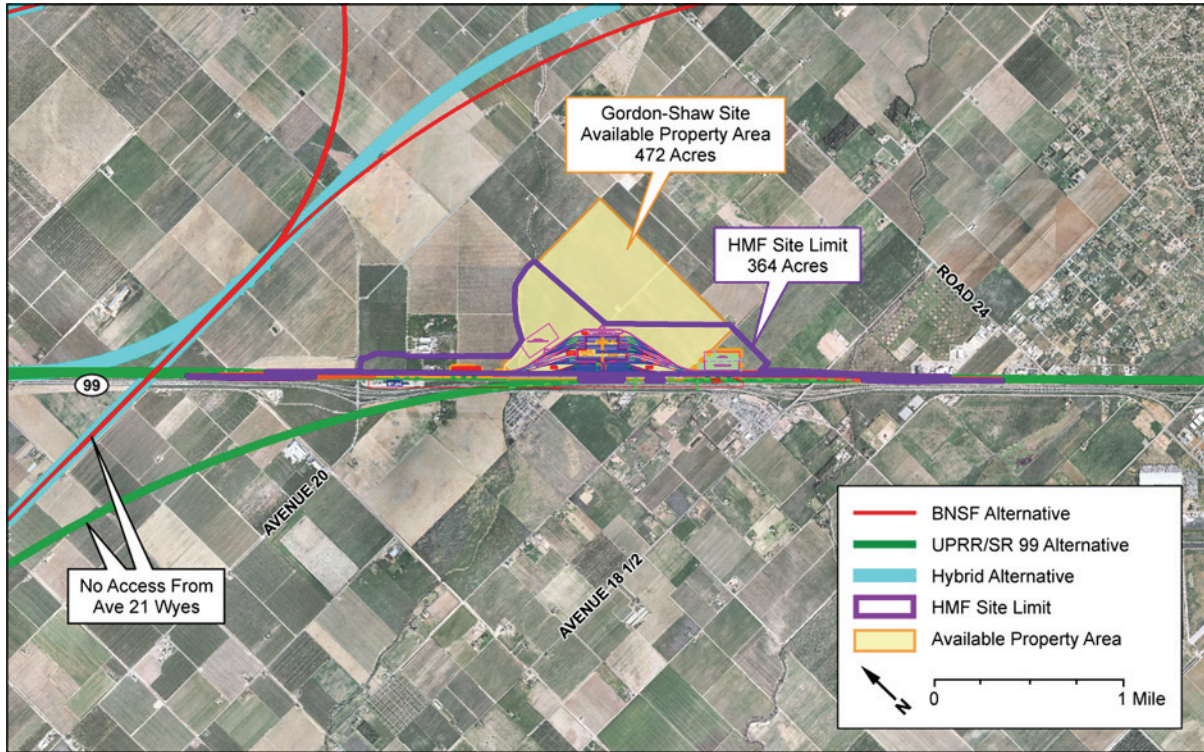

Figure 2-66
 Proposed Gordon-Shaw HMF Site

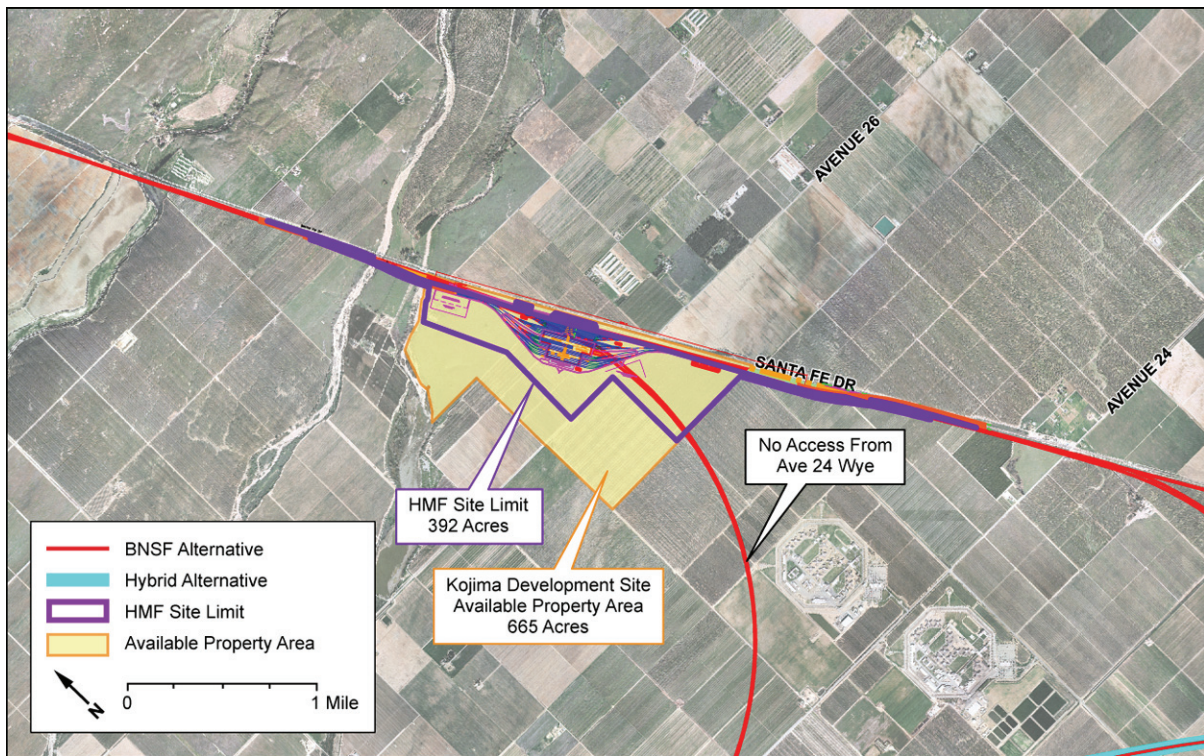

Figure 2-67
 Proposed Kojima Development HMF Site

2.5 Travel Demand and Ridership Forecasts

New ridership forecasts were prepared to support ongoing planning for the HST System and the analysis included in this EIR/EIS. Ridership forecasts were developed for the year 2030 by Cambridge Systematics, Inc. These 2030 forecasts were prepared using a 4,667-zone ridership and revenue model developed by Cambridge Systematics in 2005-2007 for the Metropolitan Transportation Commission (MTC) in partnership with the Authority. Using HST operating plan assumptions (see *Operations and Service Plan Summary* [provided in Appendix 5-A]), including run times and station stops for a variety of express, semi-express, and local trains, Cambridge Systematics tested numerous combinations of system phasing, parking cost, and HST fares. Two primary forecasting scenarios were created: one assuming full system operation between Sacramento, San Diego, San Francisco, and Anaheim, and one assuming Phase 1 HST operation between San Francisco, Merced, and Anaheim.

Cambridge Systematics also developed 2035 statewide regional growth estimates and applied these to the 2030 forecasts to develop 2035 forecasts. These forecasts were then used to estimate ridership levels as shown in Table 2-14. These figures, in turn, were then extrapolated to produce 2020 estimates based on predicted growth rates for 2030, assuming that only 40% of the forecast ridership would materialize in its first year, 60% in the second, 80% in the third, and finally reaching its forecast levels for the year in 2023. More details on the modeling and forecasts are set out the *California High-Speed Rail Ridership and Revenue Model: Development, Application, and Project-Level Forecasts* (Authority and FRA 2011a).

Table 2-14
 HST System Ridership Forecasts (in millions per year)

Fare Scenario	2020	2027	2035	
	Phase 1	Full System	Phase 1 ^a	Full System
HST ticket price 83% of airfare levels	13.2	47.6	40.2	69.3
HST ticket price 50% of airfare levels	18.7	67.5	57.0	98.2

^a Although the full system is expected to be implemented by 2027, these forecasts provide “worst case” scenarios for Merced, a busy terminus station in Phase 1, and a lower-volume mid-line station in the full system.

With higher passenger fares (i.e., 83% of airfare levels), Phase 1 would carry 13.2 million riders in the first year (2020), growing to 36.1 million by 2026, the last full year before the assumed implementation of the full system. In its first assumed year of operation, 2027, the full system would carry 47.6 million passengers, growing to over 69 million in 2035. The forecast of 69 million passengers annually for the 2035 full system represents the *low* forecast for this EIR/EIS.

With lower passenger fares (i.e., 50% of airfare levels), Phase 1 would carry 18.7 million passengers in 2020, growing to 51.3 million in 2026. The full system in its first year, 2027, would carry 67.5 million passengers, growing to over 98 million in 2035. The forecast of 98 million passengers annually for the 2035 full system represents the *high* forecast for this EIR/EIS.

This range of ridership forecasts allowed for the development of certain aspects of the HST System design and certain portions of the environmental analysis, as described in more detail below. Eventual HST System ridership will depend on many uncertain factors, such as the price of gasoline or eventual cost of an HST ticket. Accordingly, the HST System analyzed in this document is designed to accommodate the broad range of future ridership over the coming decades.

2.5.1 Ridership and HST System Design

The HST System is a long-term transportation investment for the State of California. Many components of the HST System infrastructure have a design life of 30, 50, and even 100 years. The HST System

analyzed in this EIR/EIS is designed to provide adequate infrastructure and facilities for a state-of-the-art, high-speed passenger train system over many decades. At the same time, certain components of the HST System are more flexible and are expected to change and adapt depending on how HST ridership grows over time.

Total forecasted annual ridership on the HST System is not the primary driver of HST system design. While the Authority and FRA have weighed ridership and revenue potential in evaluating alignment and station alternatives in the Tier 1 Program EIR/EIS documents and Tier 2 alternatives screening, the design of most HST System components is dictated by the agencies' performance objectives and safety requirements, rather than by total annual ridership. The HST System will be a two-track system throughout, with four tracks at intermediate stations, regardless of total annual ridership. Track geometry and profile, power distribution systems, train control/signal systems, and the type of rolling stock will be the same whether the HST System has 50 million riders annually or 100 million. Most station elements also will be the same regardless of total annual ridership, such as platform design and other necessary station components. The locations of the HMF and the light maintenance facilities are dictated by technical requirements for the HST System, not by ridership.

Ridership does influence HST System design in some respects. The size of the HMF and the light maintenance facilities is based on the 2035 full system high ridership forecast to ensure adequate sizing of these facilities to accommodate maximum future needs. This approach is consistent with general planning and design practices for a large infrastructure project, acquiring enough land for future needs up front rather than trying to purchase property at a later date when it may no longer be available or impractical to acquire. This would allow early phases of maintenance facility construction and later expansion as fleet size and maintenance requirements grow.

For stations, forecasted annual ridership and peak-period ridership play a role in determining the size of some station components, such as those required for public access and egress to the HST System. The 2035 full-system, high-ridership forecast formed the basis for the conceptual service plan, which in turn influenced the station designs so that station facilities would be sufficient to accommodate the anticipated future use of the HST System, which is expected to build over time.

For station-area parking facilities, the 2035 full system high ridership forecast was used to capture the maximum potential parking demand and to allow for an analysis of where and how parking demand might be accommodated near the HST station. For the Merced HST station, however, the maximum ridership and parking demand would occur with the Phase 1 operation; therefore, Phase 1 operations were used for the analysis of the Merced station. Parking facilities are expected to be phased in over time as demand grows. The EIR/EIS reliance on the high forecasts for parking provides flexibility to change or even reduce the amount of station parking as improved transit-oriented development (TOD) occurs around station areas.

2.5.2 Ridership and Environmental Impact Analysis

The level of annual HST ridership plays a role in the analysis of environmental impacts and benefits for traffic, air quality, noise, and energy. For these areas, this EIR/EIS uses the high ridership forecast for analyzing the anticipated adverse environmental impacts of building and operating the HST System. This worst-case approach ensures disclosure of the higher level of adverse environmental effects that may occur with higher ridership (e.g., pass-by train noise, station-area traffic). If eventual ridership is lower, adverse environmental impacts would also be lower. For environmental benefits from the HST System (e.g., transportation, air quality, energy), a lower level of ridership would reduce the level of benefits provided by the HST System. This is discussed in more detail in Chapter 3.

2.5.3 Ridership and Station Area Parking

HST System ridership, parking demand, parking supply, and development around HST stations are intertwined and anticipated to evolve from commencement of revenue service in 2020 to full system operations in 2035. The Authority's goals are to ensure access to the HST System by providing

automobile parking and also to promote—in partnership with cities—TOD around HST stations and expansion of local transit to bring riders to HST stations. This is a delicate balance that would evolve over time and vary by station, as some cities and regions will develop their station areas and local transit systems more than others by 2020 and 2035.

Research suggests that the percentage of transit passengers arriving and departing transit stations by car and needing to park decreases as land use development and population around the stations increases. The Authority's adopted station area development policies recognize this inverse relationship between parking demand and HST station area development. HST will be most successful if stations are placed where there is or will be a high density of population, jobs, commercial activities, entertainment, and other activities that generate trips. The Authority's policies, therefore, encourage dense development around HST stations, which supports system ridership while reducing parking demand.

Land use development around HST stations would not occur immediately, however. While HST would be a catalyst for such development, actual construction would be dictated by local land use decisions and market conditions. The Authority will encourage station area development in partnership with local government, as exemplified by the station area planning grants it has provided to the City of Fresno, but the Authority's power in this regard is limited. The actual demand for parking facilities, moreover, would depend on how HST ridership grows over time.

In light of the uncertainty over the need for station area parking, this document conservatively identifies parking facilities to meet the maximum forecast parking demand in the immediate vicinity of the stations. This scenario is an upper bound on actual needs and discloses the maximum potential environmental impact. The Authority and FRA would therefore have the flexibility to make decisions about what parking facilities to construct initially and how additional parking might be phased or adjusted depending on how the HST System ridership increases over time. For example, it is possible that some parking facilities might be constructed at the 2020 project opening, only to be replaced in whole or in part, or augmented later with development or other parking facilities.

2.6 Operations and Service Plan

2.6.1 HST Service

The conceptual HST service plan for Phase 1, starting in 2020, begins with service between Anaheim/Los Angeles running through the Central Valley from Bakersfield to Merced, and traveling northwest into the Bay Area. Subsequent stages of the HST System include a southern extension from Los Angeles to San Diego via the Inland Empire and an extension from Merced north to Sacramento, which are anticipated to be implemented in 2027 for purposes of this environmental analysis.

Trains would run in diverse patterns between various terminals. Three basic service types are envisioned:

- Express trains, which would serve major stations only, providing fast travel times; for example, between Los Angeles and San Francisco during the morning and afternoon peak with a run time of 2 hours and 40 minutes.
- Limited-stop trains, which would skip selected stops along a route to provide faster service between stations.
- All-stop trains, which would focus on regional service.

The vast majority of trains would provide limited-stop services and offer a relatively fast run time along with connectivity among various intermediate stations. Numerous limited-stop patterns would be provided, to achieve a balanced level of service at the intermediate stations. The service plan (Authority and FRA 2011d) envisions at least four limited trains per hour in each direction, all day long, on the main route between San Francisco and Los Angeles. Each intermediate station in the Bay Area, Central Valley between Fresno and Bakersfield, Palmdale in the High Desert, and Sylmar and Burbank in the San

Fernando Valley would be served by at least two limited trains every hour—offering at least two reasonably fast trains an hour to San Francisco and Los Angeles. Selected limited-stop trains would be extended south of Los Angeles as appropriate to serve projected demand.

Including the limited-stop trains on the routes between Sacramento and Los Angeles, and Los Angeles and San Diego, and the frequent-stop local trains between San Francisco and Los Angeles/Anaheim, and Sacramento and San Diego, every station on the HST network would be served by at least two trains per hour per direction throughout the day, and at least three trains per hour during the morning and afternoon peak periods. Stations with higher ridership demand would generally be served by more trains than those with lower estimated ridership demand.

The service plan provides direct train service between most station pairs at least once per hour. Certain routes may not always be served directly, and some passengers would need to transfer from one train to another at an intermediate station, such as Los Angeles Union Station, to reach their final destination. Generally, the Phase 1 and full-build conceptual operations and service plans offer a wide spectrum of direct service options and minimize the need for passengers to transfer.

Figure 2-68 shows how projected ridership and the numbers of trains would grow over time for the high scenario of ridership. In 2020, the assumed first year of Phase 1 operation, 120 trains would operate daily. This would grow to 260 daily trains in 2026, and jump to 288 when the full statewide HST system is anticipated to become operational, including the Merced to Sacramento and Los Angeles to San Diego sections. By 2035, 212 trainsets would be needed to operate 339 daily trains throughout the HST System.

Specifically for the Merced to Fresno Section, trains would take approximately 25 minutes to run between Merced and Fresno. The maximum operating speed would reach 220 mph in this section. In Phase 1 the first train would start from Merced after 5 a.m. at the earliest, and the last train would arrive before

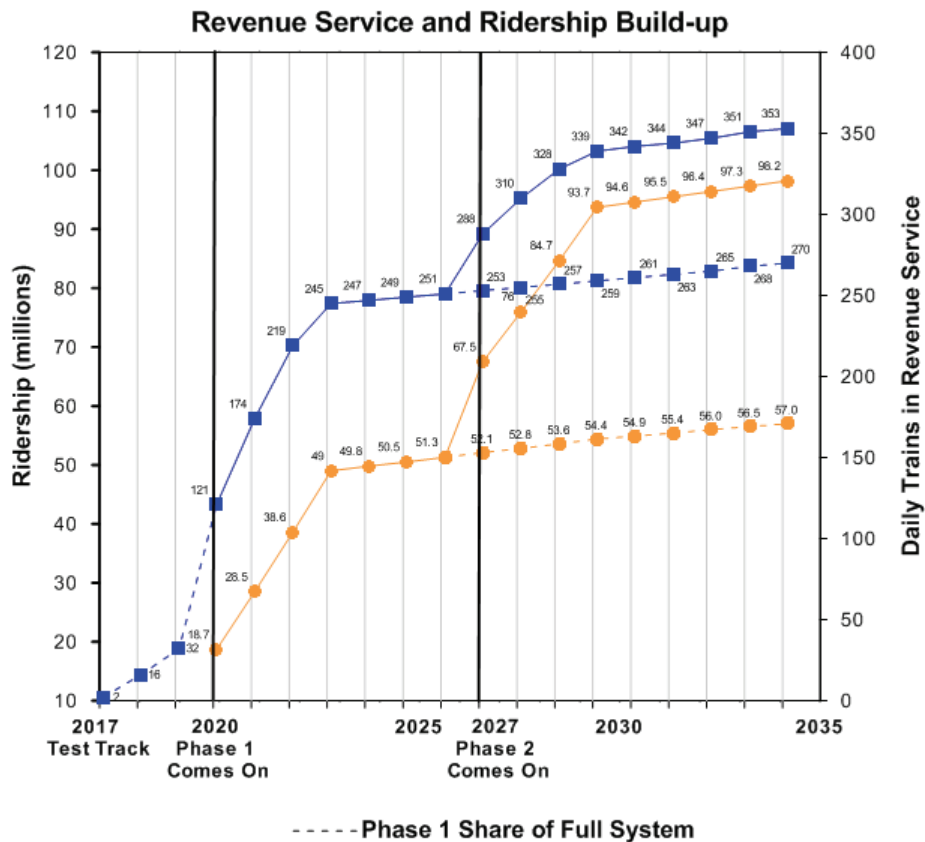

Figure 2-68
 Revenue Service and Ridership Build-Up

midnight. In the full system, trains would originate from Sacramento no earlier than 5 a.m., arriving in Merced before 6 a.m. In the late evening, the last train to Sacramento would pass through Merced shortly after 11 p.m. and reach Sacramento before midnight.

The Merced and Fresno stations would see a mix of stopping trains and through trains peaking for the full system. In 2035 for the high ridership scenario, the full system would see four trains an hour stop at Fresno in each direction at the peak, and six trains run through. At the off-peak the same number of stops would be made, but the through trains would drop to three per hour. At Merced, three trains would stop each hour per direction at the peak, with two running through. At the off-peak both of the two hourly trains would stop at Merced. (For detail, see Appendix 5-A, *Operations and Service Plan Summary*.)

2.6.2 Maintenance Activities

The Authority would regularly perform maintenance along the track and railroad right-of-way as well as the power systems, train control, signaling, communications, and other vital systems required for the safe operation of the HST system. Maintenance methods are expected to be similar to those of existing European and Asian HST systems, adapted to the specifics of the California HST. However, the FRA will specify standards of maintenance, inspection, and other items set forth in regulation (i.e., Rule of Particular Applicability or RPA) to be issued in the next several years. In addition, overseas practices may be amended in ways not currently foreseen. The brief descriptions of maintenance activities described below are thus based on existing best management practices and judgments about future maintenance practices in California.

- **Track and Right-of-Way** – The track at any point would be inspected several times a week, using measuring and recording equipment aboard special measuring trains featuring a design similar to that of the regular trains but operating at lower speed. These trains would be run between midnight and 5 a.m. and would usually pass over any given section of track once during the night.

Most adjustments to the track and routine maintenance would be accomplished in a single night at any specific location with crews and material brought by work trains along the line. When rail resurfacing is needed, perhaps several times a year, specialized equipment would pass over the track section at 5 to 10 mph.

Approximately every 4 to 5 years, ballasted track would require sections of more intensive maintenance of the track and structure using trains with a succession of specialized cars to raise, straighten, and tamp the track and vibrating “arms” used to move and position the ballast under the ties. The train would typically cover a mile-long section of track in the course of one night’s maintenance. Slab track, which is expected to comprise track at elevated sections, would not require this activity. No major track components are expected to require replacement through 2035.

Other maintenance of the right-of-way, aerial structure, and bridge sections of the line would include drain cleaning, vegetation control, litter removal, and other inspection that would typically occur monthly to several times a year.

- **Power** – The overhead catenary system (OCS) along the right-of-way would be inspected nightly with repairs being made when needed, which would typically be accomplished in one night’s maintenance window. Other inspections would occur monthly. Many of the functions and status of substations and the smaller facilities outside of the trackway would be remotely monitored, and visits would only be made to repair or replace minor items, and several times a month to check the general site. It is expected that no major component replacement would be required for the OCS or the substations through 2035.
- **Structures** – Visual inspections of the structures along the right-of-way and testing of fire and life safety systems and equipment in or on structures would occur monthly, while inspections of all structures for structural integrity would occur at least annually. Steel structures would also require

painting every several years. For tunnels and buildings, repair and replacement of lighting and communication components would be performed on a routine basis. It is expected that no major component replacement or reconstruction of any structures would be needed through 2035.

- Signaling, Train Control, and Communications – Inspection and maintenance of signaling and train control components would be guided by FRA regulations and standards to be adopted by the Authority. Typically, physical in-field inspection and testing of the system would occur four times a year using hand-operated tools and equipment. Communication components would be routinely inspected and maintained, usually at night, although daytime work may occur if the work area is clear of the trackway. No major component replacement of these systems is expected through 2035.
- Stations – Each station would be inspected and cleaned daily. Inspections of the structures, including the platforms, would occur annually. Inspections of other major systems such as escalators, the heating and ventilation system, ticket vending machines, and closed-circuit television would be according to manufacturer recommendations. It is not expected that major station components would require replacement through 2035.
- Perimeter Fencing and Intrusion Protection – Fencing and intrusion protection systems would be remotely monitored, as well as periodically inspected. Maintenance would occur as needed, but it is not expected that the fencing or systems would require replacement before 2035.

2.7 Additional High-Speed Train Development Considerations

2.7.1 High-Speed Train, Land Use Patterns, and Development around High-Speed Train Stations

In 2008, California voters approved Proposition 1A—essentially approving the California HST System. Regarding urban development and land use patterns, voters specifically mandated that HST stations “be located in areas with good access to local mass transit or other modes of transportation. The HST System also shall be planned and constructed in a manner that minimizes urban sprawl and impacts on the natural environment” including “wildlife corridors.”

In submitting Proposition 1A to the voters, the Legislature went further:

“The continuing growth in California’s population and the resulting increase in traffic congestion, air pollution, greenhouse gas emissions, and the continuation of urban sprawl make it imperative that the state proceed quickly to construct a state-of-the-art high-speed passenger train system to serve major metropolitan areas.”

The Authority has embraced this voter and legislative direction. As the Authority’s program EIR/EIS documents show and this EIR/EIS supports, operation of the HST System by itself will reduce traffic congestion, air pollution, and greenhouse gas (GHG) emissions. The Authority believes, however, that this is not enough. The HST will be most successful, and will best fulfill the intent of the voters and Legislature, if it is coordinated with sprawl-reducing and environment-improving land use development patterns. Accordingly, the Authority has adopted HST Station Area Development Policies based on the following premise:

“For the high-speed train to be more useful and yield the most benefit, it is important that the stations be placed where there will be a high density of population, jobs, commercial activities, entertainment and other activities that generate personal trips. The success of HST is highly dependent on land use patterns that also reduce urban sprawl, reduce conversion of farm land to development, reduce vehicle miles traveled (VMT) by automobiles, and encourage high-density development in and around the HST station.”

The Authority and its Station Area Development Policies specifically advocate:

- Higher density development in relation to the existing pattern of development in the surrounding area, along with minimum requirements for density.
- A mix of land uses (e.g., retail, office, hotels, entertainment, residential) and a mix of housing types to meet the needs of the local community.
- Compact pedestrian-oriented design that promotes a walking, bicycle, and transit access with streetscapes that include landscaping, small parks, and pedestrian spaces.
- Limits on the amount of parking for new development and a preference that parking be placed in structures. Transit-oriented development areas typically have reduced parking requirements for retail, office, and residential uses due to their transit and bicycle access, walkability, and potential for shared parking. Sufficient train passenger parking would be essential to the system viability, but this would be offered at market rates (not free) to encourage the use of access by transit and other modes.
- Infill development—namely, development around HST stations on land that is already disturbed by existing development, parking lots, pavement, etc., rather than development on previously undisturbed land or on farmland. The Authority, therefore, prefers to locate its stations in existing developed areas, particularly city centers.

The Authority recognizes that land use development around HST stations is controlled by local government and the market, and is influenced by public interest groups. The Authority also recognizes that local transit is controlled by regional and local transit agencies. The Authority is committed, therefore, to working cooperatively with local government, transit agencies, public interest groups, and the development community to realize a shared vision for land use and transit development around HST stations, consistent with the Authority's Development Policies to the maximum extent possible.

Good land use planning helps ensure good land use development. Planning for infill development, however, is particularly complicated. Infill areas (e.g., established downtowns) typically involve numerous small parcels with different property owners. Therefore, no single property owner exists to pay for the planning. Government typically has to fund it. The economic downturn and the State's realignment of redevelopment agencies, however, has left local government resources particularly limited. Accordingly, the Authority has committed to utilize its resources, both financial and otherwise, to encourage good local government land use planning around HST stations consistent with the above principles.

The Authority believes that implementation of its Station Area Development Policies, and cooperative work with local government (including funding for planning), will result in the types of environmental benefits voters and the Legislature contemplated in 2008. This EIR/EIS forecasts that the HST will reduce VMT and related GHG emissions, reduce energy use, reduce traffic congestion, and improve air quality. To be conservative consistent with CEQA and NEPA requirements, these forecasts generally do not account for the additional benefit to these areas expected from more compact development patterns—patterns which the Authority's Station Area Development Policies support. The Authority began the "Vision California" study effort to help account for these additional sustainability benefits that would exceed benefits reported in this EIR/EIS.

Vision California is a first-of-its-kind effort to explore the role of land use and transportation investments in meeting the environmental, fiscal, and public health challenges facing California over the coming decades. The project is producing new scenario development and analysis tools to examine the impacts of varying policy decisions and development patterns associated with accommodating the expected dramatic increase in California's population by 2050. Essentially, the Vision California's tools will quantitatively illustrate the connections between land use patterns, water and energy use, housing affordability, public health, air quality, GHG emissions, farmland preservation, infrastructure investment, and economic development. The tool will allow state agencies, regions, local governments, and the nonprofit community to measure the impacts of land use and transportation investment scenarios. More

information about Vision California is at <http://visioncalifornia.org/index.php>. Calthorpe Associates is developing the model with funds provided by the California Strategic Growth Council and the Authority.

Vision California involves two different modeling tools. An open source geo-spatial model called UrbanFootprint is map-based, and analyzes detailed base and scenario data at the 5.5-acre level across most parts of the state. It is scalable so as to permit analysis of local and regional land use and infrastructure decisions. This is a monumental endeavor - the UrbanFootprint model is in pilot testing now and will be fully operational by mid-2012. Another tool is complete now, however. Called "RapidFire," it has been deployed statewide and in regions across California. Two Vision California statewide growth scenarios - Business as Usual and Growing Smarter - were developed and analyzed in the Vision California process using RapidFire. Business as Usual assumes continuation of the past trend of less compact development patterns. Growing Smarter assumes an increasing proportion of urban infill and compact growth.

The Growing Smarter scenario is closely linked to the implementation of the HST System and supportive feeder services. This is particularly true in regions of the state, such as the San Joaquin Valley, that currently lack high-quality transit facilities, as it is not likely that the level of urban and compact growth envisioned in the Growing Smarter scenario would be realized without the significant investment and mobility enhancements represented by the California HST System.

Rapid Fire predicts that the more compact growth of the Growing Smarter scenario would result in the following by 2050:

- Saves over \$7,300 per household annually on automobile costs and utility bills.
- Saves \$1.1 billion per year from lower infrastructure costs for new homes.
- Saves 18 million acre-feet of water by 2050 - enough water to fill Hetch Hetchy reservoir 50 times.
- Cuts residential and commercial building energy use by 15%- enough to power ALL homes in California for 8 years.
- Saves over 3,700 square miles of land by 2050—more than Rhode Island and Delaware combined.
- Reduces fuel consumption through 2050 equivalent to 2 years of the USA's oil imports. Amounts to a savings of \$2,600 per year per household.
- Reduces GHG emissions equivalent to the emissions offset by a forest a quarter the size of California.
- Reduces pollution-related respiratory disease, saving more than \$1.6 billion annually.
- Reduces passenger vehicle travel (VMT) by more than 4 trillion miles, the equivalent of taking ALL cars off of California's roads for 15 years.

In conclusion, construction of the California HST System, coupled with successful implementation of the Authority's Station Area Development Policies, would serve to reinforce cities as hubs of the economy and future growth and would save land and water, reduce energy use, improve air quality, and save money. The initial findings of the Vision California study suggest that these benefits could be tremendous, and would help California meet its sustainability goals.

2.8 Construction Plan

This section summarizes the general approach to building the HST system, including activities associated with pre-construction and construction of major system components. To maintain its eligibility for federal American Recovery and Reinvestment Act (ARRA) funding, the Authority intends to begin final design and project construction in the early 2013, with construction of the Initial Operating Section (IOS) first construction to be completed by December 2018. Service on the IOS is expected to start in 2022.

The Merced to Fresno Section would be built using a “design-build” (D/B) approach. This method of project delivery involves a single contract with the project owner to provide design and construction services. This differs from the “design-bid-build” approach, where design and construction services are managed under separate contracts and the design is completed before the project is put out for construction bids. This approach offers more flexibility to adapt the project to changing conditions. The contract with the D/B contractor will require compliance with standard engineering design and environmental practices and regulations, as well as implementation of any project design features and applicable mitigation measures included in this EIR/EIS.

The Authority has prioritized a portion of the Merced to Fresno and the Fresno to Bakersfield Project sections as the first section of the California HST to be built to meet the ARRA funding requirements. The IOS first construction will be available for immediate use for improved and faster service on the San Joaquin intercity line, prior to the initiation of HST service on the IOS in 2022, providing for independent utility consistent with ARRA. The Central Valley was determined to be the best location for the initial construction, with service extending south to Palmdale and the San Fernando Valley and north to San Jose to link with blended service with the Metrolink in the south and Caltrain in the north. The Authority has met the “independent utility” requirement of the federal stimulus financing for the Merced to Fresno Section by making the first section available for improved San Joaquin intercity service. The IOS first construction track would have dedicated passenger track capable of higher speeds, thereby improving existing San Joaquin operations and would also include a basic station design (platform) for non-electrified passenger service in Fresno (located at the planned Fresno HST station).

The interim use of the IOS first construction track for upgraded San Joaquin service could have environmental impacts that differ from those analyzed in this EIR/EIS; for example, increased noise and air quality impacts with increased frequency of diesel trains during the temporary period when San Joaquin service would use the IOS first construction track (between 2018 and 2022). Service upgrades for the San Joaquin service and the potential for environmental impact would be assessed by the operating agency prior to service initiation.

2.8.1 General Approach

Upon receiving the required environmental approvals and securing needed funding, the Authority would begin implementing its construction plan through the D/B procurement process. Given the size and complexity of the HST Project, the design and construction work could be divided into a number of procurement packages. In general, the procurement would address the following:

- Civil/structural infrastructure, including design and construction of passenger stations, maintenance facilities, and right-of-way facilities.
- Trackwork, including design and construction of direct fixation track and sub-ballast, ballast, ties and rail installation, switches, and special trackwork.
- Core systems, such as traction power, train controls, communications, the operations center, and the procurement of rolling stock.

One or more D/B packages would be developed and the Authority would then issue construction requests for proposals (RFPs), start right-of-way acquisition, and procure construction management services to oversee physical construction of the project. During peak construction periods, work is envisioned to be under way at several locations along the route, with overlapping construction of various project elements. Working hours and workers present at any time would vary depending on the activities being performed. The overall general sequence of construction is envisioned in Table 2-15.

Table 2-15
 Construction Sequence

Activity	Tasks	Average Durations (months)
Right-of- Way Acquisition	Per Assembly Bill 3034, proceed with right-of-way acquisitions once State Legislature appropriates funds in the annual budget.	12 - 24
Survey & Preconstruction	Locate utilities, establish right-of-way and project control points and centerlines, establish or relocate survey monuments. ^a	6 - 8
Mobilization and Site Preparation	Relocate utilities and clear and grub right-of-way (demolition); establish detours and haul routes; erect safety devices and mobilize special construction equipment; prepare construction equipment yards and stockpile materials; establish precast concrete segment casting yard.	8 - 12
Heavy Construction	Construct aerial structures, grade separations, highway realignments, surface streets; major facilities (maintenance, stations, etc.).	30 - 36
Medium Construction	Lay tracks, install drainage facilities, conduct backfilling operations, perform street paving.	6 - 9
Light Construction	Systems installation and testing (train control systems, overhead contact system, communication system); traffic signals, street lighting, striping, closing of detours, and site clean-up.	12 – 18
<p>^a Some of the survey and pre-construction activities will occur prior to construction procurement and others may overlap with the mobilization and site preparation phase.</p> <p>^b Systems installation activities such as traffic signals and street lighting may last only 3 months, while the testing activities may last up to 18 months.</p>		

The sequencing of construction has not yet been determined. As part of the D/B procurement and award, the contractors will propose a construction schedule that will outline how the sequencing of construction will occur. As noted in Table 2-15, there are heavy construction activities that will last approximately 3 years, which means they would be underway for most of the duration of the D/B contract, following initial mobilization. Other activities, such as those identified in light construction may last only 3 months. Once the sequencing of construction activities is determined, the contractor will be able to develop a public outreach plan for the affected communities that identifies the duration of construction activities in their area and outlines a program to respond to residential concerns regarding construction effects such as noise, glare, and vibration.

Consistent with the MOU for Achieving an Environmentally Sustainable High-Speed Train System in California (Authority, FRA, U.S. Department of Housing and Urban Development, Federal Transit Administration and EPA 2011), the Authority intends to build the project using sustainable methods that:

- Minimize the use of nonrenewable resources.
- Minimize the impacts on the natural environment.
- Protect environmental diversity.
- Emphasize using renewable resources in a sustainable manner. An example of this approach would be the use of material recycling for project construction (asphalt, concrete, or Portland Cement Concrete [PCC], excavated soil, etc.).

2.8.2 Preconstruction Activities

During final design, the Authority and its contractor would conduct a number of preconstruction activities to determine how best actual construction should be staged and managed. These activities include the following:

- Conducting geotechnical investigations, which would focus on evaluating geology, groundwater, seismic, and environmental conditions along the alignment. The results of this work would guide final design and construction methods for foundations, underground structures, tunnels, stations, grade crossings, aerial structures, systems, and substations.
- Identifying staging areas and precasting yards, which would be needed for the casting, storage, and preparation of precast concrete segments, temporary spoil storage, workshops, and temporary storage of delivered construction materials. Field offices and/or temporary jobsite trailers would also be located at the staging areas.
- Initiating site preparation and demolition, such as clearing, grubbing, and grading, followed by the mobilization of equipment and materials. Demolition would require strict controls to ensure that adjacent buildings or infrastructure are not damaged or otherwise affected by the demolition efforts.
- Initiating utility relocations, where the contractor would work with the utility companies to relocate or protect in place high-risk utilities such as overhead tension wires, pressurized transmission mains, oil lines, fiber optics, and communications prior to construction.
- Implementing temporary, long-term, and permanent road closures to reroute or detour traffic away from construction activities. Handrails, fences, and walkways would be provided for the safety of pedestrians and bicyclists.
- Locating temporary batch plants, which would be required to produce PCC or asphaltic concrete (AC) needed for roads, bridges, aerial structures, retaining walls, and other large structures. The facilities would generally consist of silos containing fly ash, lime, and cement; heated tanks of liquid asphalt; sand and gravel material storage areas; mixing equipment; aboveground storage tanks; and designated areas for sand and gravel truck unloading, concrete truck loading, and concrete truck washout. The contractor would be responsible for implementing procedures for reducing air emissions, mitigating noise impacts, and reducing the potential for discharge of pollutants into storm drains or watercourses from the use of equipment, materials, and waste products.
- Conducting other studies and investigations, as needed, such as local business surveys to identify business usage, delivery, shipping patterns, and critical times of the day or year for business activities. This information would help develop construction requirements and worksite traffic control plans, and would identify potential alternative routes, cultural resource investigations, and historic property surveys.

2.8.3 Major Construction Activities

Four major sets of construction activities are briefly described below. Because there is no tunnel construction proposed for the Merced to Fresno HST Section, this construction element is not discussed.

2.8.3.1 Railroad Systems Construction

The railroad systems are to include trackwork, traction electrification, signaling, and communications. In general, trackwork is the first rail system to be constructed, and it must be in place at least locally to start traction electrification and railroad signaling installation. Trackwork construction generally requires the welding of transportable lengths of steel running onto longer lengths (approximately 1/4 mile), which are placed in position on cross-ties or track slabs and field-welded into continuous lengths from special trackwork to special trackwork.

Both tie and ballast as well as slab track construction would be used. Tie and ballast track construction, which will be used for at-grade and minor structures, typically uses cross ties and ballasts that are distributed along the trackbed by truck or tractor. In sensitive areas such as where the HST is parallel to or near streams, rivers, or wetlands, and in areas of limited accessibility, this operation may be accomplished by using the established right-of-way with material delivery via the constructed rail line. For major civil structures, slab track construction will be used. Slab track construction is a non-ballasted track form employing precast track supports.

Traction electrification equipment to be installed includes traction power substations and the overhead contact system. Traction power substations are typically fabricated and tested in a factory, then delivered by tractor-trailer to a prepared site adjacent to the alignment. It is assumed that substations are to be located every 30 miles along the alignment. The overhead contact system would be assembled in place over each track and would include poles, brackets, insulators, conductors, and other hardware.

Signaling equipment to be installed would include wayside cabinets and bungalows, wayside signals (at interlocking), switch machines, insulated joints, impedance bounds, and connecting cables. The equipment would support automatic train protection, automatic train control, and positive train control to control train separation, routing at interlocking, and speed.

2.8.3.2 Bridge, Aerial Structure, and Road Crossing Construction

Similar to existing high-speed rail systems around the world, it is anticipated that the elevated guideways would be designed and built using single box segmental girder construction. Where needed, other structural types would be considered and used, including steel girders, steel truss, and cable-supported structures.

- Foundations. A typical aerial structure foundation pile cap is supported by an average of four large-diameter bored piles with diameters ranging from 5 to 9 feet. Depth of piles depends on geotechnical site conditions. Pile construction can be achieved by using rotary drilling rigs, and either bentonite slurry or temporary casings may be used to stabilize pile shaft excavation. The estimated pile production rate is 4 days per pile installation. Additional pile installation methods available to the contractor include bored piles, rotary drilling cast-in-place piles, driven piles, and a combination of pile jetting and driving.

Upon completion of the piles, pile caps can be constructed using conventional methods. For pile caps constructed near existing structures such as railway, bridges, and underground drainage culverts, temporary sheet piling (i.e., temporary walls) can be used to minimize disturbances to adjacent structures. It is anticipated that sheet piling installation and extraction would be achieved using hydraulic sheet piling machines.

- Substructure. Aerial structures with pier heights ranging from 20 to 90 feet may be constructed using conventional jump form and scaffolding methods. A self-climbing formwork system may be used to construct piers and portal beams over 90 feet high. The self-climbing formwork system is equipped with a winched lifting device, which is raised along the column by hydraulic means with a structural frame mounted on top of the previous pour. In general, a 3-day cycle for each 12-foot pour height can be achieved. The final size and spacing of the piers depend on the type of superstructure and spans they support.
- Superstructure. It would be necessary to consider the loadings, stresses, and deflections encountered during the various intermediate construction stages, including changes in static scheme, sequence of tendon installation, maturity of concrete at loading, and load effects from erection equipment. As a result, the final design would depend on the contractor's means and methods of construction and could include several different methods, such as a span-by-span, incrementally launched, progressive cantilever, and balanced cantilever.

Road crossings of existing railroads, roads, and the HST would be constructed on the line of the existing road or offline at some locations. When constructed online, the existing road would be closed or



temporarily diverted. When constructed offline, the existing road would be maintained in use until the new crossing is completed. Where new roadway undercrossings of existing railroads are required, a temporary shoofly track would be constructed to maintain railroad operations during undercrossing construction.

Construction of foundations and substructure would be similar to that for the aerial structures, but reduced in size. The superstructure would likely be constructed using precast, prestressed, concrete girders and cast-in-place deck. Approaches to the aerial structures would be earthwork embankments, mechanically stabilized earth wall, or other retaining structures.

2.8.3.3 Excavation Support Systems

Earth support is an important factor in constructing deep excavations that would be encountered on several alignment sections. It is anticipated that the following excavation support systems may be used along the route. There are three general excavation support categories, which are described below.

- **Open Cut Slope.** Open cut slope is used in areas where sufficient room is available to open-cut the area and slope the sides back to meet the adjacent existing ground. The slopes are designed similar to any cut slope, taking into account the natural repose angle of in situ material and global stability.
- **Temporary.** A temporary excavation support structure is designed and installed to support vertical or near vertical faces of the excavation in areas where room to open-cut does not exist. This structure does not contribute to the final load carrying capacity of the tunnel structure and is either abandoned in place or dismantled as the excavation is being backfilled. Generally, it consists of soldier piles and lagging, sheet pile walls, slurry walls, secant piles, or tangent piles.
- **Permanent.** A permanent structure is designed and installed to support vertical or near vertical faces of the excavation in areas where room to open-cut does not exist. This structure forms part of the permanent final structure. Generally it consists of slurry walls, secant piles, or tangent pile walls.

2.8.3.4 Station Construction

For the Merced and Fresno stations, the worksite would occur in urban areas with both commercial and residential land uses nearby. Additional information about the station areas is provided in Section 2.4.2.4. Station improvements require significant coordination and planning to accommodate safe and convenient access to existing businesses and residences, as well as traffic control during construction periods. The typical construction sequence would be:

- **Demolition and Site Preparation.** The contractor will be required to construct detour roadways, new station entrances, construction fences and barriers, and other elements required as a result of taking existing facilities on the worksite out of service.

For new facilities, the contractor would be required to perform street improvement work, site clearing and earthwork, drainage work, and utility relocations. Additionally, substations and maintenance facilities are assumed to be newly constructed structures. For platform improvements or additional platform construction, the contractor may be required to realign existing track.

- **Structural Shell and Mechanical/Electrical Rough-Ins.** For these activities, the contractor would construct foundations and erect the structural frame for the new station, enclose the new building, and/or construct new platforms and connect the structure to site utilities. Additionally, the contractor would rough-in electrical and mechanical systems and install specialty items such as elevators, escalators, and ticketing equipment.
- **Finishes and Tenant Improvements.** The contractor would install electrical and mechanical equipment, communications and security equipment, finishes, and signage. Additionally, the contractor may install other tenant improvements if requested.

2.9 Permits

The Authority and FRA are in the process of preparing agreements with environmental resource agencies to facilitate the environmental permitting required during final design and construction. These agreements—a Memorandum of Understanding and a Memorandum of Agreement or Programmatic Agreement—will clearly identify the Authority’s responsibilities in meeting the permitting requirements of the federal, state, and regional environmental resource agencies. A Memorandum of Agreement was established in 2010 between the Authority, the FRA, the U.S. Army Corps of Engineers (USACE), and the U.S. Environmental Protection Agency (EPA) (Authority et al. 2010) regarding integration of NEPA, Clean Water Act Section 404, and Rivers and Harbors Act Section 14 processes. Coordination with the United States Coast Guard was conducted and the Coast Guard indicated that this project is not within their jurisdiction (Sulouff 2011). Table 2-16 lists the major environmental permits required for the HST Project. As a state agency, the Authority is exempt from local permit requirements; however, in order to coordinate construction activities with local jurisdictions, the Authority will seek local permits as part of construction processes consistent with local ordinances. The agencies identified in Table 2-16 are anticipated to rely on the EIR/EIS to support their permitting and approval processes.

Table 2-16
 Potential Major Environmental Permits and Approvals

Agency	Permit
Federal	
USACE	Section 404 Permit for Discharge of Dredge or Fill Materials into Waters of the U.S., including wetlands Section 10 Permit for Construction of any Structure in or over any Navigable Water of the United States
U.S. Department of Interior/Federal Railroad Administration	Section 4(f) of the U.S. Transportation Act of 1966
U.S. Advisory Council on Historic Preservation via the California State Historic Preservation Office	Section 106 Consultation (National Historic Preservation Act of 1966)
U.S. EPA	Review of Environmental Justice conclusions General Conformity Determination
U.S. Fish and Wildlife Service	Section 7 Consultation and Biological Opinion
National Marine Fisheries Service	Section 7 Consultation and Biological Opinion
State	
California Department of Fish and Game	California Endangered Species Act permits California Department of Fish and Game Section 1602 Lake and Streambed Alteration Agreement Use of Title 14 lands – Camp Pashayan under Resolution of Necessity
California Department of Transportation (Caltrans)	Caltrans Encroachment Permits
California Public Utilities Commission	Approval for construction and operation of railroad crossing of public road and for construction of new transmission lines and substations
California State Lands Commission	Lease for crossing state sovereign lands

Agency	Permit
Regional	
San Joaquin Valley Air Pollution Control District	Rule 201 General Permit Requirements, Rule 403 Fugitive Dust, Rule 442 Architectural Coatings, and Rule 902 Asbestos
Regional Water Quality Control Board	Clean Water Act Section 401 Water Quality Certification Section 402 National Pollutant Discharge Elimination System (NPDES) Water Discharge Permit Dewatering permit (Order No. 98-67) Spill Prevention, Control, and Countermeasures (SPCC) Plan (part of Section 402 process) Stormwater Construction and Operation Permit
Central Valley Flood Protection Board	Encroachment Permit for flood protection facilities